



FREIGHTLINER INTERIOR CATALOG

QUALITY.

INNOVATION.

DESIGN.

# MISSION STATEMENT

HERE AT UNITED PACIFIC, we are dedicated to providing today's drivers with innovative and exciting products that deliver exceptional performance and value. Because United Pacific's continuing success depends on our customer's satisfaction, we constantly push our designers and engineers to upgrade our facilities and processes in order to bring products of superior quality and reliability to the market. We at United Pacific promise to continue our passionate pursuit to be the first in:

QUALITY, INNOVATION AND DESIGN.

## QUALITY

With over 30 years of experience in the heavy duty trucking industry, United Pacific Industries understand the rigors and stresses that our products are subjected to on the road. It is our mission to provide our customers with products of superior quality and reliability. In achieving this goal, United Pacific only partners with manufacturing facilities that conforms to our quality control requirements and standards. Our manufacturing partners meet or exceed ISO-9001 requirements. In addition, United Pacific's manufacturing partners must be equipped on site to perform the following quality assurance tests:

- AGING TEST
- AIR TIGHT TEST
- DUST TEST
- FLUX TEST
- PHOTOMETRIC TEST
- PULL FORCE TEST
- RAIN TEST
- SALT SPRAY TEST
- SHOCK TEST
- TEMPERATURE TEST
- HUMIDITY TEST
- VIBRATION TEST

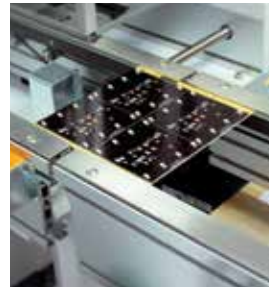

United Pacific's manufacturing partners must maintain a track record of consistent quality and low product failure rate. Furthermore, our internal quality control structure allows us to function as the final quality control station prior to shipping. With the assistance of 3D computer technology, United Pacific can adhere to strict quality control standards during prototype creation and the production process. Our engineers and technicians perform a battery of tests to ensure that our products meet the demands of today's drivers and our goal to be first in quality.





## DESIGN

Located near some of the nation's most progressive automotive design centers, United Pacific established the UP Design Studio in 2002 to consolidate our position as the design leader in the heavy duty trucking industry. UP Design Studio utilizes the latest generation of computer aided design (CAD) and studio/graphic software. The design studio is equipped with the newest computers and rapid prototyping systems. In addition, UP Design Studio is staffed by graduates from the nation's most prestigious design colleges.



Unlike our competitors, United Pacific's design and manufacturing capabilities mean that we carry more new and original items than our competitors. The establishment of the design studio will enable us to generate even more new products with significant shorter concept-to-shelf time. The reduction in development cost mean that we can develop products utilizing design based development processes. Design based product development allows United Pacific to create new product concepts based on designs incorporating driver demands and needs instead of economic considerations. United Pacific's emphasis on design distinguishes and positions us ahead of our competitors.

## HOW TO ORDER

To order from United Pacific Industries, you must be an authorized dealer, distributor or OEM.

If you are not authorized to stock and sell United Pacific products, you must order through an authorized dealer. Please call 1 (800) 790-6988 for more information.

## CONTACT US

United Pacific customer service representatives are available from:

8 am – 4:30 pm PST

Toll Free: 1 (800) 790-6988  
Fax: 1 (888) 986-5988  
Email: [sales@upauto.com](mailto:sales@upauto.com)  
Website: [UPauto.com/truck](http://UPauto.com/truck)

## INNOVATION

Known as the leader in innovation, United Pacific is dedicated to be the first to bring new and exciting products to the market. United Pacific's global expertise allows us to search the globe for new ideas and concepts. Not only do we search the globe for new products, United Pacific invest a significant amount of resources into our own research and development efforts. With the assistance of advance 3D scanning technology, our engineers and designers can acquire accurate and precise data in seconds. The 3D data allows United Pacific to verify designs, perform quality assurance tests, and reverse engineer with unprecedented speed and accuracy. Digital inspection contributes to the early detection of shape problems, provides rapid feedback on design, and eliminates unnecessary work in downstream processes. Our rapid prototyping facility permits us to have a concept-to-shelf time of less than 5 months. In addition, United Pacific's 3D printing capabilities permit our designers to have physical models of their design concepts in hours. The physical models allow our designers and marketing staff to evaluate and test the viability of different design ideas. Our rapid prototyping facility allow United Pacific to compress design cycles, improve manufacturing planning, shorten concept-to-shelf time, most importantly, generate new and innovative products.





## WARRANTY

With LED (Light Emitting Diodes) rated at 100,000 hours of operation and solid-state construction, United Pacific's LED lights are extremely reliable and durable. Purchase with confidence, United Pacific offers a complete line of LED lighting products with extended warranties. Please see the warranty policy page for more details.



## INVENTORY & SHIPPING

United Pacific carries over 20,000 items in our California distribution center. No other company in the heavy duty trucking industry can match United Pacific in the variety and range of in-stock inventories. With an order fill rate of over 98.5%, United Pacific is the largest and most reliable supplier in the industry. Our shipping department ships 96.8% of all orders within 24 hours and 98.9% within 48 hours. United Pacific's vast inventory and prompt shipping has made United Pacific the only source for our customer's chrome and lighting needs.



## ASSEMBLED IN U.S.A.

United Pacific strives to provide today's drivers with innovative and exciting products that deliver exceptional performance and value. With our international background and expertise, we search the globe for the best and most reliable products. However, as an American company, we believe and support the American way of life. Look for the "Assembled in the USA" label on many of our products. Although the components are manufactured overseas, the products, bearing the "Assembled in the USA" labels, are hand assembled with pride in the United States.



# Hard at Work for Our Customers. Hard at Work for the Environment



**United Pacific**  
**132,000** sq ft

**Distribution Center**  
**Long Beach, CA**

**100%**

reduction in potable water used for landscaping

**40%**

reduction in total energy use due to high-efficiency mechanical and lighting systems

**82%**

of construction waste was diverted from landfills

## LEED ACCOMPLISHMENTS

### Sustainable Sites

- On-site bicycle storage, showers and changing areas for company employees
- Preferred parking for low-emitting, fuel-efficient and carpool vehicles
- Stormwater is infiltrated on-site and treated to remove contaminants to reduce environmental impact on local waterways

### Water Efficiency

- In addition to using reclaimed water, drought-tolerant plants and a high-efficiency irrigation system were installed to reduce the use of potable water for irrigation by 100%
- High-efficiency water closets, lavatory faucets, and showers were used to reduce annual water use by 30%

### Energy and Atmosphere

- Efficient HVAC equipment and a lighting system with daylight controls reduces energy consumption by over 30%
- Enhanced commission verifies that the building's energy and water-related systems are performing as intended by the initial design







### Materials and Resources







- Over 81% of construction and demolition waste was diverted from landfills

### Indoor Environmental Quality

- Building ventilation system was designed to provide enhanced levels of fresh outside air to building occupants
- Interior finishes (paints, sealants, adhesives, coatings, carpet systems and composite wood) were selected with low levels of volatile organic compounds (VOCs) to reduce indoor air contamination

# TABLE OF CONTENTS

	QUICK REFERENCE	ii
	DASH ACCESSORIES	2
	Gauge Accessories.....	4
	Dash Instrument Accessories.....	9
	Toggle Switch & Switch Plate Accessories.....	13
	Rocker Switch Accessories.....	15
	Dash Screws & Knobs.....	20
	Air Valve Knob.....	28
	A/C Vents & Accessories.....	41
	Glove Box & Accessories.....	44
	LOWER CENTER DASH COLUMN	46
	Center Panel.....	47
	Cup Holder Panel.....	48
	Storage Panel.....	49
	Ashtray Cover & Trim.....	49
	Cigarette Lighter & Accessories.....	50
	Storage Compartment.....	53
	STEERING WHEEL/COLUMN ACCESSORIES	55
	Steering Wheel.....	56
	Steering Wheel Cover.....	61
	Steering Wheel Spinner.....	62
	Steering Column.....	63
	Turn Signal Cover & Handle.....	64
	LOWER DASH/FLOOR ACCESSORIES	68
	Foot Pedals.....	69
	Shift Plate.....	69
	Floor Mat.....	69
	Shift Knob.....	71
	Air Horn Valve.....	84
	INTERIOR DOOR ACCESSORIES	86
	Switch Trim.....	87
	Speaker Grill.....	88
	View Window Trim.....	89
	Door Handle Insert.....	89
	Window Crank.....	89
	Grab Handle.....	91
	Door Pocket.....	91
	Door Lock.....	92

	UPPER CAB/SLEEPER ACCESSORIES	94
	Storage Trim.....	95
	Window Post.....	96
	Speaker Cover.....	97
	Dome Light Trim.....	97
	Dome Light & Lens.....	98
	Spot Light Trim.....	99
	C.B. ACCESSORIES	100
	C.B. Knob.....	101
	C.B. Case.....	102
	C.B. Bolt.....	103
	C.B. Bracket.....	103
	C.B. Enclosure.....	104
	C.B. Microphone Cover.....	104
	C.B. Microphone Grill.....	105
	LED ACCESSORY LIGHT	106
	LED Bulb.....	106
	LED Accessories.....	113
	MISCELLANEOUS INTERIOR ACCESSORIES	123
	Accent Emblems.....	124
	Accent Letters & Scripts.....	126
	Balls.....	127
	Key Chains.....	128
	Deco Diamond Plate.....	128
	Fuzzy Dice.....	129
	MERCHANDISING	130
	TERMS, CONDITIONS & POLICIES	136
	PRODUCT INDEX	142

# 2007+ FREIGHTLINER CASCADIA





# 2007+ FREIGHTLINER CASCADIA



# FREIGHTLINER CENTURY/COLUMBIA

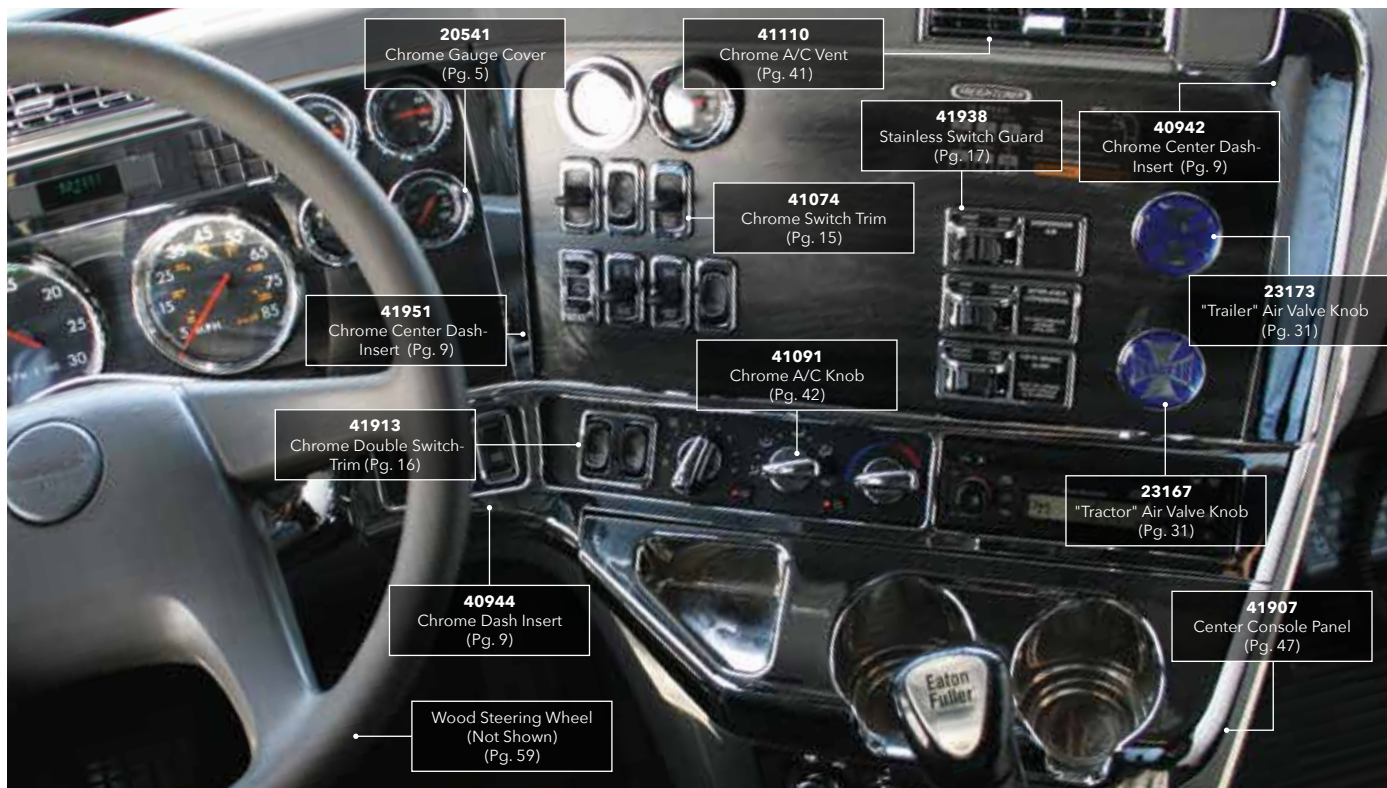

# FREIGHTLINER CENTURY/COLUMBIA

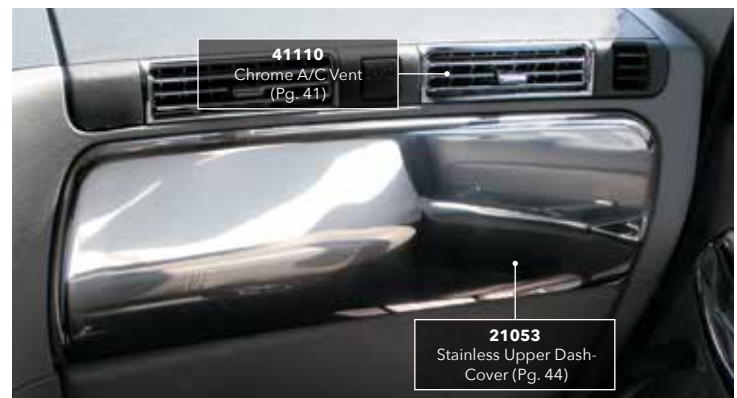
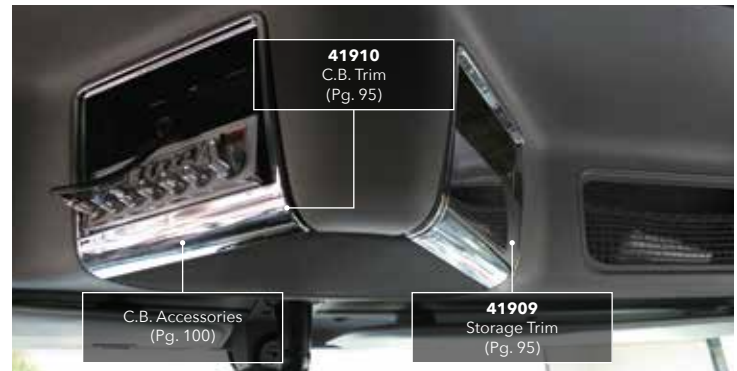

# FREIGHTLINER CLASSIC/FLD



# FREIGHTLINER CLASSIC/FLD

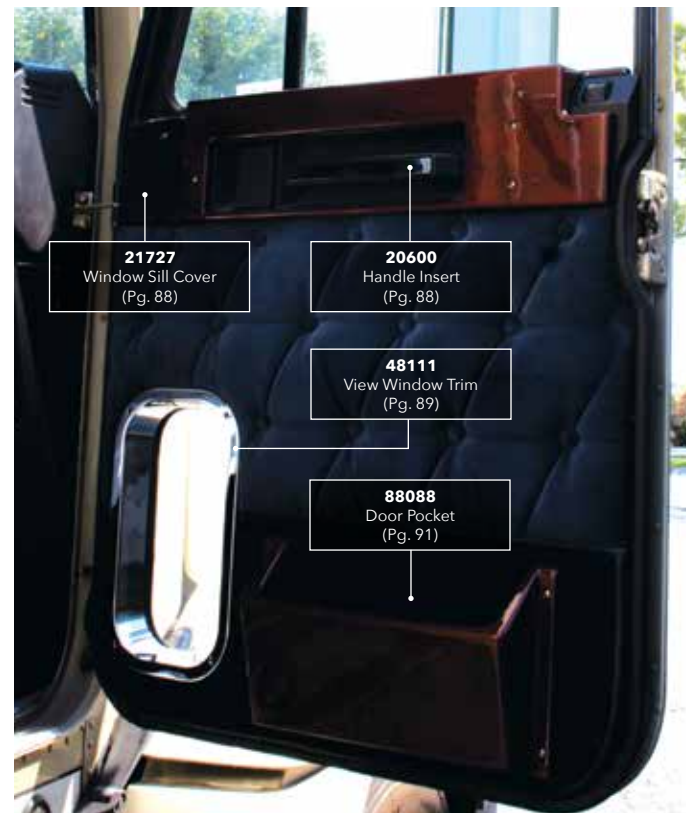

# DASH ACCESSORIES

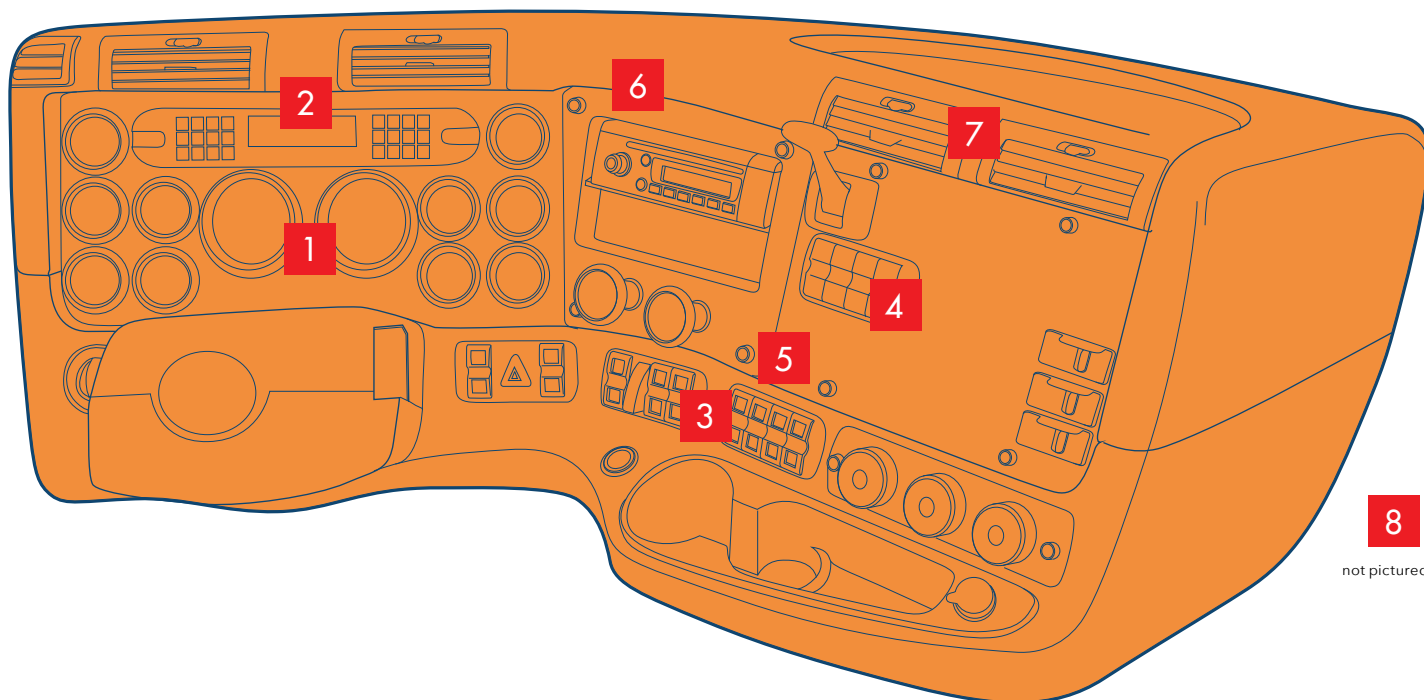

**8**  
not pictured

**1**

Gauge Cover ..... 4  
Gauge Plate ..... 8

**2**

Instrument Cover ..... 8  
Face Nut ..... 12

**3**

Toggle Switch Extension ..... 13  
Switch Nut Cover ..... 14  
Switch Label Cover ..... 14  
Switch Plates ..... 15

**4**

Rocker Switch Trim ..... 15  
Rocker Switch Cover ..... 16  
Switch Cover ..... 17  
Switch Guard ..... 17

**5**

Dash Screw ..... 20  
Dash Knob ..... 21

**6**

Dash Insert ..... 09

**7**

A/C Vent ..... 41  
A/C Knob ..... 42  
A/C Plate ..... 43  
A/C Trim ..... 43

**8**

Glove Box Cover ..... 44  
Knob Cover ..... 45



## GAUGE ACCESSORIES

## PAGE

Gauge Cover.....	4
Gauge Plate.....	8

## DASH INSTRUMENT ACCESSORIES

## PAGE

Instrument Cover.....	8
Face Nut.....	12

## TOGGLE SWITCH &amp; SWITCH PLATE

## PAGE

Toggle Switch Extension.....	13
Switch Nut Cover.....	14
Switch Label Cover.....	14
Switch Plate.....	15

## ROCKER SWITCH ACCESSORIES

## PAGE

Rocker Switch Trim.....	15
Rocker Switch Cover.....	16
Switch Cover.....	17
Switch Guard.....	17

## DASH SCREWS &amp; KNOB

## PAGE

Radio Knob.....	12
Dash Screw.....	20
Dash Knob.....	21

## A/C VENT &amp; ACCESSORIES

## PAGE

A/C Vent.....	41
A/C Knob.....	42
A/C Plate.....	43
A/C Trim.....	43

## GLOVE BOX &amp; ACCESSORIES

## PAGE

Glove Box Cover.....	44
Knob Cover.....	45

# GAUGE ACCESSORIES

## Freightliner Cascadia Dual Gauge Cover

### DESCRIPTION

- Chrome Plastic Dual Gauge Cover with Visor for Freightliner Cascadia
- Dual Gauge Cover Fits the Speedometer and Tachometer
- Fits Freightliner Cascadia and Various Other Models

Item #	Description	Package	Pack
<b>42330</b>	Speed/Tachometer	Carded	1 Pc./Card



## Freightliner Cascadia Gauge Cluster Cover - Horizontal

### DESCRIPTION

- Chrome Plastic Horizontal Gauge Cluster Cover with Visor
- Available in Dual Gauge Cluster for Small Gauges
- Fits Freightliner Cascadia and Various Other Models

Item #	Application	Package	Pack
<b>42334</b>	2 Gauge - Horizontal	Carded	1 Pc./Card



42334



## Freightliner Cascadia Small Gauge Cluster Covers - Vertical

### DESCRIPTION

- Chrome Plastic Vertical Gauge Cover with Visor
- Available in 2 or 3 Gauge Clusters
- Fits Freightliner Cascadia and Various Other Models

Item #	Description	Package	Pack
<b>42335</b>	2 Gauge - Vertical	Carded	1 Pc./Card
<b>42336</b>	3 Gauge - Vertical	Carded	1 Pc./Card



42334



42336





### Freightliner Cascadia Gauge Cover

#### DESCRIPTION

- Chrome Plastic Gauge Cover with Visor for 2007+ Freightliner Cascadia
- Proper Installation May Require Application of Adhesives to the Back

Item #	Application	Package	Pack
<b>42333</b>	Small Gauge	Carded	1 Pc./Card
<b>42371</b>	Speed/Tachometer	Carded	1 Pc./Card



42333



42371

### Freightliner Gauge Cover

#### DESCRIPTION

- Chrome Plastic Gauge Cover for Freightliner
- Available with or without Visor

Item #	Application	Visor	Pack
<b>20551</b>	Small Gauge	Yes	1 Pc./Card
<b>20550</b>	Small Gauge	No	1 Pc./Card
<b>20529</b>	Century Small Gauge	Yes	1 Pc./Card
<b>20528</b>	Century Small Gauge	No	1 Pc./Card
<b>20555</b>	Speed/Tachometer	Yes	1 Pc./Card
<b>20554</b>	Speed/Tachometer	No	1 Pc./Card
<b>20539</b>	Century Speed/Tach.	Yes	1 Pc./Card
<b>20538</b>	Century Speed/Tach.	No	1 Pc./Card



20551



20550

### Freightliner Gauge Cover - Classic Design

#### DESCRIPTION

- Chrome Plastic Gauge Cover for Freightliner
- Available with or without Visor

Item #	Application	Visor	Pack
<b>20542</b>	Pyrometer	Yes	1 Pc./Card
<b>20541</b>	Small Gauge	Yes	1 Pc./Card
<b>20561</b>	Classic/FLD Small Gauge	Yes	1 Pc./Card
<b>20560</b>	Classic/FLD Small Gauge	No	1 Pc./Card
<b>20533</b>	Speed/Tachometer	Yes	1 Pc./Card



20561



20560

### Freightliner Steel Gauge Cover

#### DESCRIPTION

- Gauge Cover for Freightliner
- Available in Chrome Steel or Stainless Steel, Hang Packed

Item #	Application	Material	Pack
<b>20511</b>	Pyrometer	Chrome	1 Pc./Pack
<b>20513</b>	Small Gauge	Chrome	1 Pc./Pack
<b>20507</b>	Small Gauge	Stainless	1 Pc./Pack
<b>20514</b>	Speed/Tachometer	Chrome	1 Pc./Pack



20513

# SIGNATURE COLLECTION

## Signature Freightliner Chrome Gauge Cover - Diamond

### DESCRIPTION

- Signature Chrome Plastic Gauge Cover with Crystal Diamond
- Available with or without Visor, Diamonds Available in 6 Colors
- US Patent: D563,815S, D579,809S, Additional Patents Pending

### Freightliner Small Gauge Cover

Item #	Application	Visor	Jewel Color	Pack
<b>20814</b>	Small Gauge	Yes	-	1 Pc./Card
<b>20815</b>	Small Gauge	Yes	Amber	1 Pc./Card
<b>20816</b>	Small Gauge	Yes	Blue	1 Pc./Card
<b>20817</b>	Small Gauge	Yes	Clear	1 Pc./Card
<b>20818</b>	Small Gauge	Yes	Green	1 Pc./Card
<b>20819</b>	Small Gauge	Yes	Purple	1 Pc./Card
<b>20820</b>	Small Gauge	Yes	Red	1 Pc./Card
<b>20821</b>	Small Gauge	No	-	1 Pc./Card
<b>20822</b>	Small Gauge	No	Amber	1 Pc./Card
<b>20823</b>	Small Gauge	No	Blue	1 Pc./Card
<b>20824</b>	Small Gauge	No	Clear	1 Pc./Card
<b>20825</b>	Small Gauge	No	Green	1 Pc./Card
<b>20826</b>	Small Gauge	No	Purple	1 Pc./Card
<b>20827</b>	Small Gauge	No	Red	1 Pc./Card



### Century, Coronado & Columbia Small Gauge Cover

Item #	Application	Visor	Jewel Color	Pack
<b>20828</b>	Small Gauge	Yes	-	1 Pc./Card
<b>20829</b>	Small Gauge	Yes	Amber	1 Pc./Card
<b>20830</b>	Small Gauge	Yes	Blue	1 Pc./Card
<b>20831</b>	Small Gauge	Yes	Clear	1 Pc./Card
<b>20832</b>	Small Gauge	Yes	Green	1 Pc./Card
<b>20833</b>	Small Gauge	Yes	Red	1 Pc./Card
<b>20834</b>	Small Gauge	Yes	-	1 Pc./Card
<b>20835</b>	Small Gauge	No	-	1 Pc./Card
<b>20836</b>	Small Gauge	No	Amber	1 Pc./Card
<b>20837</b>	Small Gauge	No	Blue	1 Pc./Card
<b>20838</b>	Small Gauge	No	Clear	1 Pc./Card
<b>20839</b>	Small Gauge	No	Green	1 Pc./Card
<b>20840</b>	Small Gauge	No	Purple	1 Pc./Card
<b>20841</b>	Small Gauge	No	Red	1 Pc./Card



### Gauge Opening Sizes\*

\*All Sizes are Approximate Measurements Only



**20551**  
Fits 2 5/16" Diameter  
Small Gauge



**42333**  
Freightliner Cascadia  
Small Gauge

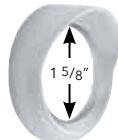

**20529**  
Fits 2 5/16" Diameter  
Century Small Gauge



**20561**  
Fits 2 5/16" Diameter  
Classic/FLD Small Gauge



**20555**  
Fits 3 3/4" Diameter  
Speed/Tachometer Gauge



**42371**  
Freightliner Cascadia  
Speed/Tachometer Gauge

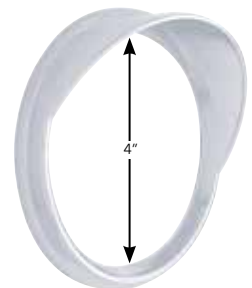

**20539**  
Fits 4 3/4" Diameter  
Century Speed/Tachometer Gauge

## Signature Freightliner Chrome Gauge Cover - Diamond

### DESCRIPTION

- Signature Chrome Plastic Gauge Cover with Crystal Diamond
- Available with or without Visor, Diamonds Available in 6 Colors
- US Patent: D563,815S, Additional Patent Pending

### Freightliner Speed/Tachometer Gauge Cover

Item #	Application	Visor	Jewel Color	Pack
40665	Speed/Tach.	Yes	Amber	1 Pc./Card
40666	Speed/Tach.	Yes	Blue	1 Pc./Card
40667	Speed/Tach.	Yes	Clear	1 Pc./Card
40668	Speed/Tach.	Yes	Green	1 Pc./Card
40669	Speed/Tach.	Yes	Purple	1 Pc./Card
40670	Speed/Tach.	Yes	Red	1 Pc./Card
40671	Speed/Tach.	No	-	1 Pc./Card
40672	Speed/Tach.	No	Amber	1 Pc./Card
40673	Speed/Tach.	No	Blue	1 Pc./Card
40674	Speed/Tach.	No	Clear	1 Pc./Card
40675	Speed/Tach.	No	Green	1 Pc./Card
40676	Speed/Tach.	No	Purple	1 Pc./Card
40677	Speed/Tach.	No	Red	1 Pc./Card



40670

### Century, Coronado & Columbia Speed/Tach. Gauge Cover

Item #	Application	Visor	Jewel Color	Pack
40622	Speed/Tach.	Yes	-	1 Pc./Card
40623	Speed/Tach.	Yes	Amber	1 Pc./Card
40624	Speed/Tach.	Yes	Blue	1 Pc./Card
40625	Speed/Tach.	Yes	Clear	1 Pc./Card
40626	Speed/Tach.	Yes	Green	1 Pc./Card
40627	Speed/Tach.	Yes	Red	1 Pc./Card
40628	Speed/Tach.	Yes	-	1 Pc./Card
40629	Speed/Tach.	No	-	1 Pc./Card
40630	Speed/Tach.	No	Amber	1 Pc./Card
40631	Speed/Tach.	No	Blue	1 Pc./Card
40632	Speed/Tach.	No	Clear	1 Pc./Card
40633	Speed/Tach.	No	Green	1 Pc./Card
40634	Speed/Tach.	No	Purple	1 Pc./Card
40635	Speed/Tach.	No	Red	1 Pc./Card



40673

## Chrome Freightliner Center Gauge Cluster Cover - Visor

### DESCRIPTION

- Chrome Plastic Center Gauge Cluster Cover with Visor for Columbia
- Also Fits Various Freightliner Cascadia and M2 Models

Item #	Description	Package	Pack
42068	Gauge Cover w/ Visor	Carded	1 Pc./Card



## Freightliner Stainless Steel Gauge Plate

### DESCRIPTION

- Stainless Steel Gauge Plates for Kenworth
- Laser Etched for Unparalleled Detail

Item #	Description	Pack
<b>48082</b>	Air Apply	1 Pc./Card
<b>48083</b>	Air Dual	1 Pc./Card
<b>48084</b>	Air Filter	1 Pc./Card
<b>48085</b>	Air Pressure Applied	1 Pc./Card
<b>48085-1</b>	Air Pressure - Dual PRI/SEC	1 Pc./Card
<b>48129</b>	Air PRI	1 Pc./Card
<b>48130</b>	Air SEC	1 Pc./Card
<b>48131</b>	Air Suspension	1 Pc./Card
<b>48086</b>	Ammeter	1 Pc./Card
<b>48087</b>	Engine Hour Meter	1 Pc./Card
<b>48088</b>	Engine Oil Temperature	1 Pc./Card
<b>48089</b>	Engine RPM x 100	1 Pc./Card
<b>48090</b>	Front Driver Temperature	1 Pc./Card
<b>48091</b>	Fuel Level	1 Pc./Card
<b>48092</b>	Fuel Pressure	1 Pc./Card
<b>48093</b>	Fuel Vac in Hg	1 Pc./Card
<b>48094</b>	Main Transmission Temperature	1 Pc./Card
<b>48095</b>	Oil PSI	1 Pc./Card
<b>48096</b>	Outside Air Temperature	1 Pc./Card
<b>48097</b>	Pyrometer (Small)	1 Pc./Card
<b>48098</b>	Pyrometer (Large)	1 Pc./Card
<b>48099</b>	Rear Driver Temperature	1 Pc./Card
<b>48120</b>	Speedometer (Style 1)	1 Pc./Card
<b>48121</b>	Speedometer (Style 2)	1 Pc./Card
<b>48122</b>	Tachometer	1 Pc./Card
<b>48123</b>	Turbo PSI	1 Pc./Card
<b>48132</b>	VAC in H <sub>2</sub> O	1 Pc./Card
<b>48124</b>	Voltage	1 Pc./Card
<b>48126</b>	Water Temperature (Style 2)	1 Pc./Card



## Chrome Freightliner Cascadia Instrument Cover

### DESCRIPTION

- Chrome Plastic Center Instrument Cover for Freightliner Cascadia
- Fits 12 7/8" L x 2 1/8" Tall Instrument Panel, Cutout for Warning Lights

Item #	Description	Package	Pack
<b>42372</b>	Instrument Cover	Carded	1 Pc./Card



## Freightliner Instrument Panel Cover

### DESCRIPTION

- Chrome Plastic Center Dash Instrument Panel Cover for Freightliner
- Fits 10 1/2" L x 2" Tall Instrument Panel, Cutout for Warning Lights

Item #	Description	Package	Pack
<b>41965</b>	Instrument Panel Cover	Carded	1 Pc./Card



# DASH INSTRUMENT ACCESSORIES

## Freightliner Vertical Dash Insert - Right

### DESCRIPTION

- Chrome Plastic Dash Insert for FL Century, Coronado, and Columbia
- Fits Various Years and Models

Item #	Description	Package	Pack
<b>40942</b>	Right Dash Insert	Carded	1 Pc./Card



## Freightliner Lower Dash Insert - Left

### DESCRIPTION

- Chrome Plastic Dash Insert for Century, Coronado, and Columbia
- Fits Various Years and Models

Item #	Description	Package	Pack
<b>40943</b>	Left Lower Dash	Carded	1 Pc./Card
<b>40944</b>	Right Lower Dash	Carded	1 Pc./Card

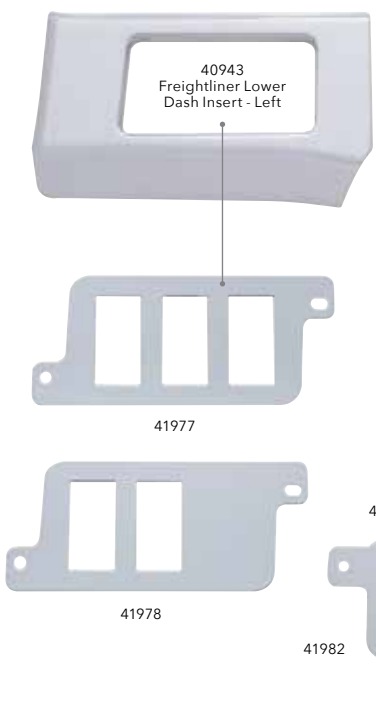

## Freightliner Center Dash Insert - Diamond

### DESCRIPTION

- Chrome Plastic Center Dash Insert for Freightliner Century, Coronado, and Columbia
- Available with or without Crystal Diamonds

Item #	Style	Jewel Color	Package	Pack
<b>41953</b>	Diamond	Amber	Carded	1 Pc./Card
<b>41954</b>	Diamond	Blue	Carded	1 Pc./Card
<b>41955</b>	Diamond	Clear	Carded	1 Pc./Card
<b>41956</b>	Diamond	Green	Carded	1 Pc./Card
<b>41957</b>	Diamond	Purple	Carded	1 Pc./Card
<b>41958</b>	Diamond	Red	Carded	1 Pc./Card
<b>41952</b>	Indented	-	Carded	1 Pc./Card
<b>41951</b>	Plain	-	Carded	1 Pc./Card



## Freightliner Lower Dash Switch Panel

### DESCRIPTION

- Chrome Plastic Lower Dash Switch Panel for Freightliner
- Please Specify Left or Right & the Number of Openings
- Fits Various Models and Years

Item #	Side	Openings	Package	Pack
<b>41977</b>	Left	3	Carded	1 Pc./Card
<b>41978</b>	Left	2	Carded	1 Pc./Card
<b>41980</b>	Right	3	Carded	1 Pc./Card
<b>41981</b>	Right	2	Carded	1 Pc./Card
<b>41982</b>	Right	1	Carded	1 Pc./Card

**Freightliner Light Panel Trim**

## DESCRIPTION

- Chrome Plastic Light Panel Trim for Century, Coronado & Columbia

Item #	Description	Package	Pack
<b>41917</b>	Light Panel Trim	Carded	1 Pc./Card

**Freightliner Radio Panel Trim**

## DESCRIPTION

- Chrome Plastic Radio Panel Trim for Century, Coronado, & Columbia

Item #	Description	Package	Pack
<b>41921</b>	Radio Panel Trim	Carded	1 Pc./Card

**Freightliner A/C Control Panel Trim**

## DESCRIPTION

- Chrome Plastic A/C Panel Trim for Century, Coronado, & Columbia

Item #	Description	Package	Pack
<b>41915</b>	A/C Control Panel Trim	Carded	1 Pc./Card

**Freightliner Switch Panel Trim**

## DESCRIPTION

- Chrome Plastic Key Panel Trim for Century, Coronado & Columbia

Item #	Description	Package	Pack
<b>41919</b>	Key Panel Trim	Carded	1 Pc./Card

**Freightliner Cascadia Radio/Air Valve Trim**

## DESCRIPTION

- Chrome Plastic Radio/Air Valve Trim for 2007+ Freightliner Cascadia

Item #	Description	Package	Pack
<b>42301</b>	Radio/Air Valve Trim	Carded	1 Pc./Card



### Freightliner Instrument Panel Trim

DESCRIPTION

- Chrome Plastic Instrument Panel Trim for Freightliner
- Available with or without Visor, Fits Various Models and Years

Item #	Description	Visor	Pack
<b>40995</b>	Classic/FLD Panel	No	1 Pc./Card
<b>41911</b>	10 1/4" x 1 15/16" Panel	Yes	1 Pc./Card
<b>41912</b>	10 1/4" x 1 15/16" Panel	No	1 Pc./Card



40995



41911



41912

### Freightliner Trailer Brake Cover - Diamond

DESCRIPTION

- Chrome Plastic Trailer Brake Cover for Freightliner
- Available with or without Diamond

Item #	Style	Jewel Color	Package	Pack
<b>41991</b>	Diamond	Amber	Carded	1 Pc./Card
<b>41992</b>	Diamond	Blue	Carded	1 Pc./Card
<b>41993</b>	Diamond	Clear	Carded	1 Pc./Card
<b>41994</b>	Diamond	Green	Carded	1 Pc./Card
<b>41995</b>	Diamond	Purple	Carded	1 Pc./Card
<b>41996</b>	Diamond	Red	Carded	1 Pc./Card
<b>41990</b>	Indented	-	Carded	1 Pc./Card



41991



41992



41993



41994



41995



41996



41990

### Freightliner Button Panel Trim

DESCRIPTION

- Push Button Panel Trim for Century, Coronado & Columbia
- Available in Chrome, Chrome Plastic, or Stainless Steel
- Item # 41129 is a Complete Replacement
- Item # 48510 and Item # 42059 Fit Over the OEM Panel
- Item # 42059 Fits Newer Century, Coronado & Columbia Models

Item #	Description	Package	Pack
<b>41129</b>	Chrome Button Panel	Carded	1 Pc./Card
<b>48510</b>	Stainless Panel Cover	Carded	1 Pc./Card
<b>42059</b>	Chrome Button Panel Cover	Carded	1 Pc./Card



41129



48510



42059



### Freightliner Trailer Brake Handle Base Cover

DESCRIPTION

- Chrome Plastic Trailer Brake Handle Base Cover for Freightliner
- Easy Installation

Item #	Description	Package	Pack
<b>41974</b>	Brake Handle Base Cover	Carded	1 Pc./Card



### Freightliner Engine Electronic Display Cover

DESCRIPTION

- Chrome Plastic Engine Electronic Display Cover
- Fits Various Engine Electronic Display Modules

Item #	Description	Package	Pack
<b>41006</b>	CAT Engine Display	Carded	1 Pc./Card
<b>40992</b>	Detroit Diesel Engine Display	Carded	1 Pc./Card
<b>40996</b>	Cummings Engine Display	Carded	1 Pc./Card



### Freightliner Indicator Label Cover

DESCRIPTION

- Chrome Plastic Indicator Label Cover for Freightliner
- Available with or without Visor, Fits Freightliner Classic and FLD

Item #	Fit	Visor	Pack
<b>40958</b>	Classic/FLD	Yes	6 Pcs./Card
<b>41001</b>	Classic/FLD	No	1 Pc./Card



### Delphi Radio Knob - Diamond

DESCRIPTION

- Chrome Plastic Delphi Radio Knob
- Available with or without Diamond
- Universal Application, Fits OEM Delphi Radios

Item #	Style	Jewel Color	Package	Pack
<b>41266</b>	Diamond	Amber	Carded	1 Pc./Card
<b>41267</b>	Diamond	Blue	Carded	1 Pc./Card
<b>41268</b>	Diamond	Clear	Carded	1 Pc./Card
<b>41269</b>	Diamond	Green	Carded	1 Pc./Card
<b>41270</b>	Diamond	Purple	Carded	1 Pc./Card
<b>41271</b>	Diamond	Red	Carded	1 Pc./Card
<b>41272</b>	Diamond	Smoke	Carded	1 Pc./Card
<b>41265</b>	Indented	-	Carded	1 Pc./Card
<b>41264</b>	Plain	-	Carded	1 Pc./Card



### Freightliner Key Switch Face Nut

DESCRIPTION

- Chrome Key Switch Face Nut for Freightliner Classic and FLD
- Available Carded or Bulk

Item #	Description	Package	Pack
<b>21005</b>	Key Switch Face Nut	Card	1 Pc./Card
<b>21005B</b>	Key Switch Face Nut	Bulk	1 Pc./Bulk



Front



# TOGGLE SWITCH & SWITCH PLATE ACCESSORIES

## Measurements



Short Toggle Switch Extension - Item # 40183

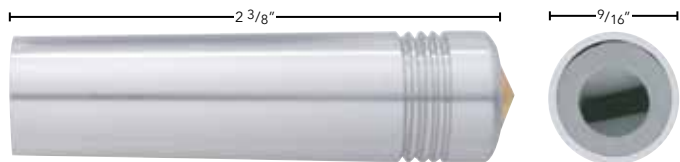

Long Toggle Switch Extension - Item # 40158

## Freightliner Toggle Switch Extension - Pointed

### DESCRIPTION

- Aluminum Pointed Toggle Switch Extension
- Long Toggle Switch Extension Size: 9/16" I.D. x 2 3/8" Long
- Short Toggle Switch Extension Size: 9/16" I.D. x 1 5/8" Long

Item #	Size	Length	Package	Pack
<b>40037</b>	Long	2 3/8"	Hang Tag	1 Pc./Bag
<b>40037P</b>	Long	2 3/8"	Carded	2 Pcs./Card
<b>40182</b>	Short	1 5/8"	Hang Tag	1 Pc./Bag



40037



40182

## Freightliner Bullet Casing Toggle Switch Cover

### DESCRIPTION

- Bullet Casing Toggle Switch Cover for Freightliner
- Unique Bullet Casing Design

Item #	Description	Package	Pack
<b>40058</b>	Bullet Casing Toggle Switch	Carded	2 Pcs./Card

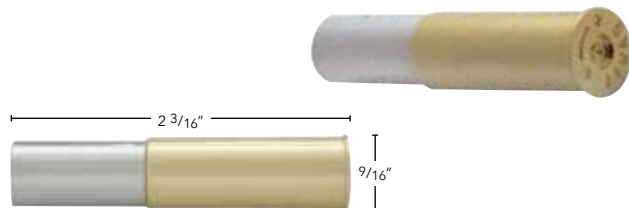

## Freightliner Chrome Toggle Switch Extension - Diamond

### DESCRIPTION

- Chrome Aluminum Toggle Switch Extension with Crystal Diamond
- Long Toggle Switch Extension Size: 9/16" I.D. x 2 3/8" Long
- Short Toggle Switch Extension Size: 9/16" I.D. x 1 5/8" Long

## Long Freightliner Toggle Switch Extension with Diamond

Item #	Style	Jewel Color	Package	Pack
<b>40158</b>	Diamond	Amber	Hang Tag	1 Pc./Bag
<b>40158</b>	Diamond	Amber	Carded	2 Pcs./Card
<b>40038</b>	Diamond	Blue	Hang Tag	1 Pc./Bag
<b>40038P</b>	Diamond	Blue	Carded	2 Pcs./Card
<b>40043</b>	Diamond	Clear	Hang Tag	1 Pc./Bag
<b>40043P</b>	Diamond	Clear	Carded	2 Pcs./Card
<b>40039</b>	Diamond	Green	Hang Tag	1 Pc./Bag
<b>40039P</b>	Diamond	Green	Carded	2 Pcs./Card
<b>40041</b>	Diamond	Purple	Hang Tag	1 Pc./Bag
<b>40041P</b>	Diamond	Purple	Carded	2 Pcs./Card
<b>40042</b>	Diamond	Red	Hang Tag	1 Pc./Bag
<b>40042P</b>	Diamond	Red	Carded	2 Pcs./Card

## Short Freightliner Toggle Switch Extension with Diamond

Item #	Style	Jewel Color	Package	Pack
<b>40183</b>	Diamond	Amber	Hang Tag	1 Pc./Bag
<b>40184</b>	Diamond	Blue	Hang Tag	1 Pc./Bag
<b>40188</b>	Diamond	Clear	Hang Tag	1 Pc./Bag
<b>40185</b>	Diamond	Green	Hang Tag	1 Pc./Bag
<b>40186</b>	Diamond	Purple	Hang Tag	1 Pc./Bag
<b>40187</b>	Diamond	Red	Hang Tag	1 Pc./Bag



## Freightliner Plastic Toggle Switch Extension

### DESCRIPTION

- Chrome Plastic Toggle Switch Extension for Freightliner
- Switch Extension Size: 1 1/2" x 2"

Item #	Description	Package	Pack
<b>40164</b>	Chrome Switch Extension	Carded	4 Pcs./Card



### Freightliner Chrome Toggle Switch Nut Cover

DESCRIPTION

- Chrome Plastic Toggle Switch Nut Cover for Freightliner
- Fits Various Models and Years

Item #	Description	Package	Pack
<b>40893</b>	Switch Nut Cover	Carded	6 Pcs./Card



### Freightliner Chrome Switch Face Nut

DESCRIPTION

- Chrome Face Nut for Freightliner Toggle Switches
- Available Carded or Bulk, Fits Various Models and Years

Item #	Description	Package	Pack
<b>21002P</b>	Switch Nut Cover	Carded	6 Pcs./Card
<b>21002</b>	Switch Nut Cover	Bulk	1 Pc.

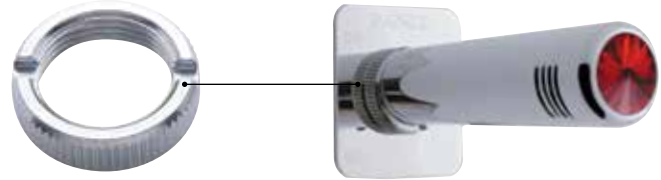

### Toggle Switch/Face Nut Installation Kit

DESCRIPTION

- Kit Includes Stainless Steel Face Nut Installation/Removal Tool and Allen Wrench
- All the Tools You Need to Install Toggle Switches & Face Nuts

Item #	Description	Package	Pack
<b>21008</b>	Installation Kit	Carded	1 Kit/Card



### Freightliner Indicator Label Cover

DESCRIPTION

- Chrome Plastic Indicator Label Cover for Freightliner
- Available with or without Visor, Fits Freightliner Classic and FLD

Item #	Fit	Visor	Pack
<b>40958</b>	Classic/FLD	Yes	6 Pcs./Card
<b>41001</b>	Classic/FLD	No	1 Pc./Card



### Freightliner Stainless Steel Switch Plate

#### DESCRIPTION

- Stainless Steel Switch Plate for Freightliner
- Laser Etched for Unparalleled Detail, Sold Carded

Item #	Description	Pack
<b>48058</b>	ABS Check	1 Pc./Card
<b>48059</b>	Check Engine	1 Pc./Card
<b>48060</b>	Cruise Control (2 Switches)	1 Pc./Card
<b>48061</b>	Driving Lights	1 Pc./Card
<b>48063</b>	Engine Brake (2 Switches)	1 Pc./Card
<b>48066</b>	Engine Start	1 Pc./Card
<b>48068</b>	Fuel/Tach	1 Pc./Card
<b>48070</b>	Ignition	1 Pc./Card
<b>48072</b>	Panel Lights	1 Pc./Card



### Freightliner Stainless Steel Freightliner Plate

#### DESCRIPTION

- Stainless Steel Freightliner Plate
- Available w/ Shutdown Override Script

Item #	Description	Pack
<b>48079</b>	Shutdown Override	1 Pc./Card
<b>48080</b>	Parking Brake	1 Pc./Card
<b>48081</b>	Axle Lock	1 Pc./Card



# ROCKER SWITCH

### Freightliner Cascadia Blank Switch Insert

#### DESCRIPTION

- Chrome Plastic Blank Switch Insert for Freightliner Cascadia
- Fits all Cascadia Models and Years

Item #	Description	Package	Pack
<b>42349</b>	Blank Switch Insert	Carded	2 Pcs./Card

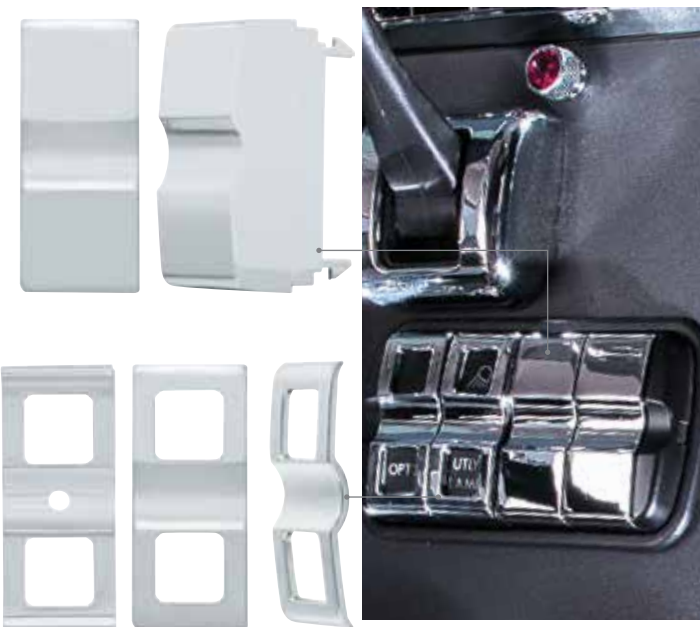

### Freightliner Cascadia Switch Cover - 2 Openings

#### DESCRIPTION

- Chrome Plastic Freightliner Cascadia Switch Cover
- Double Side Tape Installation

Item #	Description	Package	Pack
<b>42417</b>	Switch Cover w/ 3 Openings	Carded	1 Pc./Card
<b>42350</b>	Switch Cover w/ 2 Openings	Carded	1 Pc./Card

### Rocker Switch Trim

#### DESCRIPTION

- Chrome Plastic Rocker Switch Trim
- Available with or without Switch Guard

Item #	Description	Package	Pack
<b>41147</b>	Trim with Switch Guard	Carded	3 Pcs./Card
<b>41147B</b>	Trim with Switch Guard	Bulk	1 Pc.
<b>41074</b>	Plain Switch Trim	Carded	3 Pcs./Card
<b>41074B</b>	Plain Switch Trim	Bulk	1 Pc.



### Rocker Switch Trim - 2 Openings

DESCRIPTION

- Chrome Plastic Rocker Switch Trim with Two Openings
- Fits Freightliner Century & Columbia

Item #	Description	Package	Pack
<b>41913</b>	Double Switch Trim	Carded	1 Pc./Card



### Rocker Switch Trim - Diamond

DESCRIPTION

- Chrome Plastic Rocker Switch Cover with Three Openings
- Fits Various Models, Available with or without Diamond

Item #	Style	Jewel Color	Package	Pack
<b>41141</b>	Diamond	Amber	Carded	3 Pcs./Card
<b>41142</b>	Diamond	Blue	Carded	3 Pcs./Card
<b>41143</b>	Diamond	Clear	Carded	3 Pcs./Card
<b>41144</b>	Diamond	Green	Carded	3 Pcs./Card
<b>41145</b>	Diamond	Purple	Carded	3 Pcs./Card
<b>41146</b>	Diamond	Red	Carded	3 Pcs./Card
<b>41140</b>	Indented	-	Carded	3 Pcs./Card
<b>41140B</b>	Indented	-	Bulk	1 Pc.



### Freightliner Rocker Switch Cover - Diamond/3 Openings

DESCRIPTION

- Chrome Plastic Rocker Switch Cover with Three Openings
- Fits Various Models, Available with or without Diamond

Item #	Style	Jewel Color	Package	Pack
<b>42040</b>	Diamond	Blue	Carded	3 Pcs./Card
<b>42041</b>	Diamond	Clear	Carded	3 Pcs./Card
<b>42042</b>	Diamond	Green	Carded	3 Pcs./Card
<b>42043</b>	Diamond	Purple	Carded	3 Pcs./Card
<b>42044</b>	Diamond	Red	Carded	3 Pcs./Card
<b>42045</b>	Diamond	Smoke	3 Pcs./Card	
<b>42039</b>	Indented	-	Carded	3 Pcs./Card
<b>42038</b>	Plain	-	Carded	3 Pcs./Card



### Freightliner Rocker Switch Cover - Diamond

DESCRIPTION

- Chrome Plastic Rocker Switch Cover for Freightliner
- Fits Various Models, Available with or without Diamond

Item #	Style	Jewel Color	Package	Pack
<b>42050</b>	Diamond	Blue	Carded	3 Pcs./Card
<b>42051</b>	Diamond	Clear	Carded	3 Pcs./Card
<b>42052</b>	Diamond	Green	Carded	3 Pcs./Card
<b>42053</b>	Diamond	Purple	Carded	3 Pcs./Card
<b>42054</b>	Diamond	Red	Carded	3 Pcs./Card
<b>42055</b>	Diamond	Smoke	Carded	3 Pcs./Card
<b>42048</b>	Indented	-	Carded	3 Pcs./Card
<b>42047</b>	Plain	-	Carded	3 Pcs./Card



### Freightliner Wiper Switch Trim

DESCRIPTION

- Chrome Plastic Wiper Switch Trim
- Fits Newer Freightliner Century, Coronado & Columbia

Item #	Description	Package	Pack
<b>41948</b>	Wiper Switch Trim	Carded	1 Pc./Card

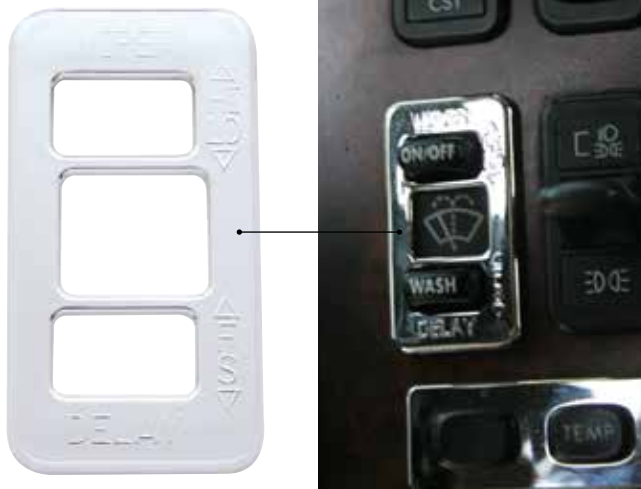

### Freightliner Toggle Switch Trim

DESCRIPTION

- Chrome Plastic Toggle Switch Trim for Freightliner
- Two Styles Available

Item #	Description	Package	Pack
<b>41938</b>	Older 3 3/8" x 1 1/2" Switch	Carded	3 Pcs./Card
<b>41973</b>	Older 3 3/8" x 1 1/2" Switch	Carded	1 Pc./Card
<b>41939</b>	Newer 2 1/2" x 1 1/16" Switch	Carded	3 Pcs./Card



### Freightliner Switch Guard

DESCRIPTION

- Stainless Steel Freightliner Switch Guard, Laser Etched Lettering
- Available with 5 Different Scripts
- Fits 3 3/8" x 1 1/2" Freightliner Rocker Switch

Item #	Description	Package	Pack
<b>48500</b>	Fifth Wheel	Skin Packed	1 Pc./Pack
<b>48501</b>	Inter-Axle Differential	Skin Packed	1 Pc./Pack
<b>48502</b>	Rear Traction Control	Skin Packed	1 Pc./Pack
<b>48503</b>	Suspension Air	Skin Packed	1 Pc./Pack
<b>48504</b>	Traction Control Differential	Skin Packed	1 Pc./Pack



48500

48501



48502

48503



48504

### Freightliner Headlight Switch Cover

DESCRIPTION

- Chrome Plastic Headlight Switch Cover for Freightliner
- Fits Newer Freightliner Models

Item #	Description	Package	Pack
<b>42066</b>	Headlight Switch Cover	Carded	1 Pc./Card



## Freightliner Switch Guard with Glossy Sticker

### DESCRIPTION

- Chrome Plastic Switch Guard with Glossy Sticker for Freightliner
- Available with 5 Different Scripts in 6 Different Colors

### Freightliner Switch Guard - Axle-Differential

Item #	Description	Color	Pack
21012	Axle-Differential	Black	1 Pc./Card
21010	Axle-Differential	Blue	1 Pc./Card
21011	Axle-Differential	Green	1 Pc./Card
21013	Axle-Differential	Purple	1 Pc./Card
21014	Axle-Differential	Red	1 Pc./Card
21015	Axle-Differential	Silver	1 Pc./Card

### Freightliner Switch Guard - Fifth Wheel

Item #	Description	Color	Pack
21022	Fifth Wheel	Black	1 Pc./Card
21020	Fifth Wheel	Blue	1 Pc./Card
21021	Fifth Wheel	Green	1 Pc./Card
21023	Fifth Wheel	Purple	1 Pc./Card
21024	Fifth Wheel	Red	1 Pc./Card
21025	Fifth Wheel	Silver	1 Pc./Card

### Freightliner Switch Guard - PTO

Item #	Description	Color	Pack
21072	PTO	Black	1 Pc./Card
21070	PTO	Blue	1 Pc./Card
21071	PTO	Green	1 Pc./Card
21073	PTO	Purple	1 Pc./Card
21074	PTO	Red	1 Pc./Card
21075	PTO	Silver	1 Pc./Card

### Freightliner Switch Guard - Suspension Air

Item #	Description	Color	Pack
21028	Suspension Air	Black	1 Pc./Card
21026	Suspension Air	Blue	1 Pc./Card
21027	Suspension Air	Green	1 Pc./Card
21029	Suspension Air	Purple	1 Pc./Card
21030	Suspension Air	Red	1 Pc./Card
21031	Suspension Air	Silver	1 Pc./Card

### Freightliner Switch Guard - Traction Control Differential

Item #	Description	Color	Pack
21046	Traction Control Differential	Black	1 Pc./Card
21044	Traction Control Differential	Blue	1 Pc./Card
21045	Traction Control Differential	Green	1 Pc./Card
21047	Traction Control Differential	Purple	1 Pc./Card
21048	Traction Control Differential	Red	1 Pc./Card
21049	Traction Control Differential	Silver	1 Pc./Card



21012



21021



21074



21028



21048

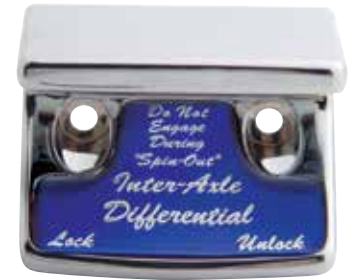

21010



21023



21075



21026



21049



**Freightliner Switch Guard - Switch Guard Only**

DESCRIPTION

- Chrome Plastic Switch Guard for Freightliner
- Switch Guard Only, Sticker Sold Separately

Item #	Description	Package	Pack
<b>21010-1</b>	Switch Guard	Bulk	1 Pc.



21010-1K



21020-1B



21070-1G



21026-1P



21044-1R



21010-1S

**Freightliner Switch Guard Glossy Sticker Only**

DESCRIPTION

- Glossy Freightliner Switch Guard Sticker, Sticker Only
- Available with 5 Different Scripts in 6 Different Colors
- Available in Bulk Only

**Glossy Axle-Differential Sticker**

Item #	Description	Color	Pack
<b>21010-1K</b>	Axle-Differential	Black	1 Pc.
<b>21010-1B</b>	Axle-Differential	Blue	1 Pc.
<b>21010-1G</b>	Axle-Differential	Green	1 Pc.
<b>21010-1P</b>	Axle-Differential	Purple	1 Pc.
<b>21010-1R</b>	Axle-Differential	Red	1 Pc.
<b>21010-1S</b>	Axle-Differential	Silver	1 Pc.

**Glossy Fifth Wheel Sticker**

Item #	Description	Color	Pack
<b>21020-1K</b>	Fifth Wheel	Black	1 Pc.
<b>21020-1B</b>	Fifth Wheel	Blue	1 Pc.
<b>21020-1G</b>	Fifth Wheel	Green	1 Pc.
<b>21020-1P</b>	Fifth Wheel	Purple	1 Pc.
<b>21020-1R</b>	Fifth Wheel	Red	1 Pc.
<b>21020-1S</b>	Fifth Wheel	Silver	1 Pc.

**Glossy PTO Sticker**

Item #	Description	Color	Pack
<b>21070-1K</b>	PTO	Black	1 Pc.
<b>21070-1B</b>	PTO	Blue	1 Pc.
<b>21070-1G</b>	PTO	Green	1 Pc.
<b>21070-1P</b>	PTO	Purple	1 Pc.
<b>21070-1R</b>	PTO	Red	1 Pc.
<b>21070-1S</b>	PTO	Silver	1 Pc.

**Glossy Suspension Air Sticker**

Item #	Description	Color	Pack
<b>21026-1K</b>	Suspension Air	Black	1 Pc.
<b>21026-1B</b>	Suspension Air	Blue	1 Pc.
<b>21026-1G</b>	Suspension Air	Green	1 Pc.
<b>21026-1P</b>	Suspension Air	Purple	1 Pc.
<b>21026-1R</b>	Suspension Air	Red	1 Pc.
<b>21026-1S</b>	Suspension Air	Silver	1 Pc.

**Glossy Traction Control Differential Sticker**

Item #	Description	Color	Pack
<b>21044-1K</b>	Traction Control Differential	Black	1 Pc.
<b>21044-1B</b>	Traction Control Differential	Blue	1 Pc.
<b>21044-1G</b>	Traction Control Differential	Green	1 Pc.
<b>21044-1P</b>	Traction Control Differential	Purple	1 Pc.
<b>21044-1R</b>	Traction Control Differential	Red	1 Pc.
<b>21044-1S</b>	Traction Control Differential	Silver	1 Pc.

# DASH SCREWS & KNOBS

## 2007+ Freightliner Cascadia Chrome Dash Screw

### DESCRIPTION

- Chrome Dash Screws with Crystal Diamond for 2007+ FL Cascadia
- Available with 7 Different Color Jewels

Item #	Style	Jewel Color	Package	Pack
<b>23914</b>	Diamond	Amber	Hang Tag	1 Pc./Bag
<b>23915</b>	Diamond	Blue	Hang Tag	1 Pc./Bag
<b>23916</b>	Diamond	Clear	Hang Tag	1 Pc./Bag
<b>23917</b>	Diamond	Green	Hang Tag	1 Pc./Bag
<b>23918</b>	Diamond	Purple	Hang Tag	1 Pc./Bag
<b>23919</b>	Diamond	Red	Hang Tag	1 Pc./Bag
<b>23913</b>	Indented	-	Hang Tag	1 Pc./Bag
<b>23913B</b>	Indented	-	Bulk	1 Pc.



## Freightliner Chrome Long Dash Screw - Diamond

### DESCRIPTION

- Chrome Long Dash Screws with Crystal Diamond for Freightliner
- Available in 2 Different Sizes with 6 Different Color Jewels

Item #	Style	Jewel Color	Package	Pack
<b>24052</b>	Diamond	Blue	Carded	2 Pcs./Card
<b>24052B</b>	Diamond	Blue	Bulk	1 Pc.
<b>24053</b>	Diamond	Clear	Carded	2 Pcs./Card
<b>24053B</b>	Diamond	Clear	Bulk	1 Pc.
<b>24054</b>	Diamond	Green	Carded	2 Pcs./Card
<b>24054B</b>	Diamond	Green	Bulk	1 Pc.
<b>24055</b>	Diamond	Purple	Carded	2 Pcs./Card
<b>24055B</b>	Diamond	Purple	Bulk	1 Pc.
<b>24056</b>	Diamond	Red	Carded	2 Pcs./Card
<b>24056B</b>	Diamond	Red	Bulk	1 Pc.



## Freightliner Chrome Short Dash Screw - Diamond

### DESCRIPTION

- Chrome Short Dash Screws with Crystal Diamond for Freightliner
- Available in 2 Different Sizes with 6 Different Color Jewels

Item #	Style	Jewel Color	Package	Pack
<b>23839</b>	Diamond	Blue	Carded	2 Pcs./Card
<b>23839B</b>	Diamond	Blue	Bulk	1 Pc.
<b>23840</b>	Diamond	Clear	Carded	2 Pcs./Card
<b>23840B</b>	Diamond	Clear	Bulk	1 Pc.
<b>23841</b>	Diamond	Green	Carded	2 Pcs./Card
<b>23841B</b>	Diamond	Green	Bulk	1 Pc.
<b>23842</b>	Diamond	Purple	Carded	2 Pcs./Card
<b>23842B</b>	Diamond	Purple	Bulk	1 Pc.
<b>23843</b>	Diamond	Red	Carded	2 Pcs./Card
<b>23843B</b>	Diamond	Red	Bulk	1 Pc.
<b>23837P</b>	Plain	-	Carded	2 Pcs./Card
<b>23837</b>	Plain	-	Bulk	1 Pc.



## Freightliner Chrome Dash Screw - OEM Style

### DESCRIPTION

- OEM Style Chrome Dash Screw for Freightliner

Item #	Description	Package	Pack
<b>23856</b>	OEM Dash Screw	Carded	33 Pcs./Card
<b>23856B</b>	OEM Dash Screw	Bulk	1 Pc.

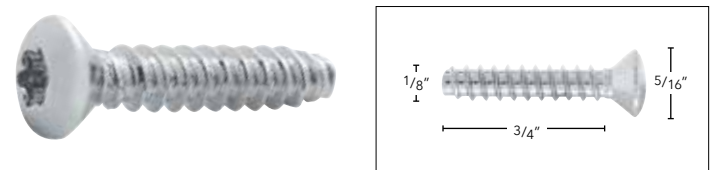



### Designer Dash Knob

DESCRIPTION

- Small Chrome Aluminum Designer Dash Knob
- Hex Screw Mount, Universal Application
- Available in Gun Barrel or Keg Design

Item #	Description	Package	Pack
<b>23398</b>	Gun Barrel Knob	Carded	1 Pc./Card
<b>23377</b>	Keg Knob	Carded	1 Pc./Card



### Chrome Deluxe Dash Knob - Diamond

DESCRIPTION

- Small Deluxe Chrome Aluminum Dash Knob with Crystal Diamond
- Hex Screw Mount, Universal Application

Item #	Style	Jewel Color	Package	Pack
<b>23582</b>	Diamond	Amber	Carded	1 Pc./Card
<b>23583</b>	Diamond	Blue	Carded	1 Pc./Card
<b>23584</b>	Diamond	Clear	Carded	1 Pc./Card
<b>23585</b>	Diamond	Green	Carded	1 Pc./Card
<b>23586</b>	Diamond	Purple	Carded	1 Pc./Card
<b>23587</b>	Diamond	Red	Carded	1 Pc./Card
<b>23581</b>	Indented	-	Carded	1 Pc./Card
<b>23581B</b>	Indented	-	Bulk	1 Pc.



### Chrome Deluxe Dash Knob - Knob Only

DESCRIPTION

- Small Deluxe Chrome Aluminum Dash Knob with Groove for Sticker
- Sticker not Included, Hex Screw Mount

Item #	Description	Package	Pack
<b>23390</b>	Deluxe Knob	Carded	1 Pc./Card
<b>23390B</b>	Deluxe Knob	Bulk	1 Pc.



### Chrome Deluxe Knob - Glossy Maltese Cross Sticker

DESCRIPTION

- Small Chrome Deluxe Dash Knob with Glossy Maltese Cross Sticker
- Hex Screw Mount, Universal Application
- Available in 4 Different Scripts in 6 Different Colors

Item #	Script	Sticker Color	Package	Pack
<b>23136</b>	Fan/Air	Black	Carded	1 Pc./Card
<b>23137</b>	Fan/Air	Blue	Carded	1 Pc./Card
<b>23138</b>	Fan/Air	Green	Carded	1 Pc./Card
<b>23139</b>	Fan/Air	Purple	Carded	1 Pc./Card
<b>23140</b>	Fan/Air	Red	Carded	1 Pc./Card
<b>23141</b>	Fan/Air	Silver	Carded	1 Pc./Card
<b>23142</b>	Lights	Black	Carded	1 Pc./Card
<b>23143</b>	Lights	Blue	Carded	1 Pc./Card
<b>23144</b>	Lights	Green	Carded	1 Pc./Card
<b>23145</b>	Lights	Purple	Carded	1 Pc./Card
<b>23146</b>	Lights	Red	Carded	1 Pc./Card
<b>23147</b>	Lights	Silver	Carded	1 Pc./Card
<b>23148</b>	Washer	Black	Carded	1 Pc./Card
<b>23149</b>	Washer	Blue	Carded	1 Pc./Card
<b>23150</b>	Washer	Green	Carded	1 Pc./Card
<b>23151</b>	Washer	Purple	Carded	1 Pc./Card
<b>23152</b>	Washer	Red	Carded	1 Pc./Card
<b>23153</b>	Washer	Silver	Carded	1 Pc./Card
<b>23154</b>	Wiper	Black	Carded	1 Pc./Card
<b>23155</b>	Wiper	Blue	Carded	1 Pc./Card
<b>23156</b>	Wiper	Green	Carded	1 Pc./Card
<b>23157</b>	Wiper	Purple	Carded	1 Pc./Card
<b>23158</b>	Wiper	Red	Carded	1 Pc./Card
<b>23159</b>	Wiper	Silver	Carded	1 Pc./Card



### Chrome Deluxe Knob - Glossy Sticker

#### DESCRIPTION

- Small Chrome Dash Knob with Glossy Sticker, Hex Screw Mount
- Available with 5 Different Scripts in 6 Different Colors

Item #	Script	Sticker Color	Package	Pack
23391	Fan/Air	Black	Carded	1 Pc./Card
23392	Fan/Air	Blue	Carded	1 Pc./Card
23393	Fan/Air	Green	Carded	1 Pc./Card
23394	Fan/Air	Purple	Carded	1 Pc./Card
23395	Fan/Air	Red	Carded	1 Pc./Card
23396	Fan/Air	Silver	Carded	1 Pc./Card
23436	Panel Lights	Black	Carded	1 Pc./Card
23437	Panel Lights	Blue	Carded	1 Pc./Card
23438	Panel Lights	Green	Carded	1 Pc./Card
23439	Panel Lights	Purple	Carded	1 Pc./Card
23440	Panel Lights	Red	Carded	1 Pc./Card
23441	Panel Lights	Silver	Carded	1 Pc./Card
23442	Washer	Black	Carded	1 Pc./Card
23443	Washer	Blue	Carded	1 Pc./Card
23444	Washer	Green	Carded	1 Pc./Card
23445	Washer	Purple	Carded	1 Pc./Card
23446	Washer	Red	Carded	1 Pc./Card
23447	Washer	Silver	Carded	1 Pc./Card
23448	Wiper	Black	Carded	1 Pc./Card
23449	Wiper	Blue	Carded	1 Pc./Card
23450	Wiper	Green	Carded	1 Pc./Card
23451	Wiper	Purple	Carded	1 Pc./Card
23452	Wiper	Red	Carded	1 Pc./Card
23453	Wiper	Silver	Carded	1 Pc./Card
23454	Wiper/Washer	Black	Carded	1 Pc./Card
23455	Wiper/Washer	Blue	Carded	1 Pc./Card
23456	Wiper/Washer	Green	Carded	1 Pc./Card
23457	Wiper/Washer	Purple	Carded	1 Pc./Card
23458	Wiper/Washer	Red	Carded	1 Pc./Card
23459	Wiper/Washer	Silver	Carded	1 Pc./Card



23391



23437



23444



23451



### Chrome Deluxe Dash Knob - Aluminum Sticker

#### DESCRIPTION

- Small Chrome Dash Knob with Aluminum Sticker, Hex Screw Mount
- Available with 5 Different Scripts in 6 Different Colors

Item #	Script	Sticker Color	Package	Pack
23460	Fan/Air	Black	Carded	1 Pc./Card
23461	Fan/Air	Blue	Carded	1 Pc./Card
23462	Fan/Air	Green	Carded	1 Pc./Card
23463	Fan/Air	Purple	Carded	1 Pc./Card
23464	Fan/Air	Red	Carded	1 Pc./Card
23465	Fan/Air	Silver	Carded	1 Pc./Card
23466	Panel Lights	Black	Carded	1 Pc./Card
23467	Panel Lights	Blue	Carded	1 Pc./Card
23468	Panel Lights	Green	Carded	1 Pc./Card
23469	Panel Lights	Purple	Carded	1 Pc./Card
23470	Panel Lights	Red	Carded	1 Pc./Card
23471	Panel Lights	Silver	Carded	1 Pc./Card
23472	Washer	Black	Carded	1 Pc./Card
23473	Washer	Blue	Carded	1 Pc./Card
23474	Washer	Green	Carded	1 Pc./Card
23475	Washer	Purple	Carded	1 Pc./Card
23476	Washer	Red	Carded	1 Pc./Card
23477	Washer	Silver	Carded	1 Pc./Card
23478	Wiper	Black	Carded	1 Pc./Card
23479	Wiper	Blue	Carded	1 Pc./Card
23480	Wiper	Green	Carded	1 Pc./Card
23481	Wiper	Purple	Carded	1 Pc./Card
23482	Wiper	Red	Carded	1 Pc./Card
23483	Wiper	Silver	Carded	1 Pc./Card
23484	Wiper/Washer	Black	Carded	1 Pc./Card
23485	Wiper/Washer	Blue	Carded	1 Pc./Card
23486	Wiper/Washer	Green	Carded	1 Pc./Card
23487	Wiper/Washer	Purple	Carded	1 Pc./Card
23488	Wiper/Washer	Red	Carded	1 Pc./Card
23489	Wiper/Washer	Silver	Carded	1 Pc./Card



23460



23481



23470

### Chrome Deluxe Dash Knob - Stainless Steel Plaque

#### DESCRIPTION

- Small Chrome Deluxe Dash Knob with Stainless Steel Plaque
- Available with 6 Different Scripts, Hex Screw Mount

Item #	Script	Plaque	Package	Pack
23490	Dimmer	Stainless	Carded	1 Pc./Card
23492	Panel Lights	Stainless	Carded	1 Pc./Card
23493	Washer	Stainless	Carded	1 Pc./Card
23494	Wiper	Stainless	Carded	1 Pc./Card
23495	Wiper/Washer	Stainless	Carded	1 Pc./Card



23490



23492



23493

### Chrome Dash Knob - Knob Only

**DESCRIPTION**

- Small Chrome Aluminum Dash Knob with Groove for Sticker
- Sticker not Included, Hex Screw Mount

Item #	Description	Package	Pack
<b>23030-1P</b>	Knob Only	Carded	1 Pc./Card
<b>23030-1</b>	Knob Only	Bulk	1 Pc.



### Chrome Dash Knob - Glossy Maltese Cross Sticker

**DESCRIPTION**

- Small Chrome Dash Knob with Glossy Maltese Cross Sticker
- Hex Screw Mount, Universal Application
- Available with 4 Different Scripts in 6 Different Colors

Item #	Script	Sticker Color	Package	Pack
<b>23606</b>	Fan/Air	Black	Carded	1 Pc./Card
<b>23607</b>	Fan/Air	Blue	Carded	1 Pc./Card
<b>23608</b>	Fan/Air	Green	Carded	1 Pc./Card
<b>23609</b>	Fan/Air	Purple	Carded	1 Pc./Card
<b>23610</b>	Fan/Air	Red	Carded	1 Pc./Card
<b>23611</b>	Fan/Air	Silver	Carded	1 Pc./Card
<b>23612</b>	Lights	Black	Carded	1 Pc./Card
<b>23613</b>	Lights	Blue	Carded	1 Pc./Card
<b>23614</b>	Lights	Green	Carded	1 Pc./Card
<b>23615</b>	Lights	Purple	Carded	1 Pc./Card
<b>23616</b>	Lights	Red	Carded	1 Pc./Card
<b>23617</b>	Lights	Silver	Carded	1 Pc./Card
<b>23618</b>	Washer	Black	Carded	1 Pc./Card
<b>23619</b>	Washer	Blue	Carded	1 Pc./Card
<b>23620</b>	Washer	Green	Carded	1 Pc./Card
<b>23622</b>	Washer	Red	Carded	1 Pc./Card
<b>23623</b>	Washer	Silver	Carded	1 Pc./Card
<b>23624</b>	Wiper	Black	Carded	1 Pc./Card
<b>23625</b>	Wiper	Blue	Carded	1 Pc./Card
<b>23626</b>	Wiper	Green	Carded	1 Pc./Card
<b>23627</b>	Wiper	Purple	Carded	1 Pc./Card
<b>23628</b>	Wiper	Red	Carded	1 Pc./Card
<b>23629</b>	Wiper	Silver	Carded	1 Pc./Card



23606



23613

### Chrome Dash Knob - Glossy Sticker

**DESCRIPTION**

- Small Chrome Dash Knob with Glossy Sticker, Hex Screw Mount
- Available with 5 Different Scripts in 6 Different Colors

Item #	Script	Sticker Color	Package	Pack
<b>23249</b>	Fan/Air	Black	Carded	1 Pc./Card
<b>23250</b>	Fan/Air	Blue	Carded	1 Pc./Card
<b>23251</b>	Fan/Air	Green	Carded	1 Pc./Card
<b>23252</b>	Fan/Air	Purple	Carded	1 Pc./Card
<b>23253</b>	Fan/Air	Red	Carded	1 Pc./Card
<b>23254</b>	Fan/Air	Silver	Carded	1 Pc./Card
<b>23215</b>	Panel Lights	Black	Carded	1 Pc./Card
<b>23216</b>	Panel Lights	Blue	Carded	1 Pc./Card
<b>23218</b>	Panel Lights	Purple	Carded	1 Pc./Card
<b>23219</b>	Panel Lights	Red	Carded	1 Pc./Card
<b>23220</b>	Panel Lights	Silver	Carded	1 Pc./Card
<b>23208</b>	Washer	Black	Carded	1 Pc./Card
<b>23209</b>	Washer	Blue	Carded	1 Pc./Card
<b>23210</b>	Washer	Green	Carded	1 Pc./Card
<b>23211</b>	Washer	Purple	Carded	1 Pc./Card
<b>23212</b>	Washer	Red	Carded	1 Pc./Card
<b>23213</b>	Washer	Silver	Carded	1 Pc./Card
<b>23201</b>	Wiper	Black	Carded	1 Pc./Card
<b>23202</b>	Wiper	Blue	Carded	1 Pc./Card
<b>23203</b>	Wiper	Green	Carded	1 Pc./Card
<b>23204</b>	Wiper	Purple	Carded	1 Pc./Card
<b>23205</b>	Wiper	Red	Carded	1 Pc./Card
<b>23206</b>	Wiper	Silver	Carded	1 Pc./Card
<b>23243</b>	Wiper/Washer	Black	Carded	1 Pc./Card
<b>23244</b>	Wiper/Washer	Blue	Carded	1 Pc./Card
<b>23245</b>	Wiper/Washer	Green	Carded	1 Pc./Card
<b>23246</b>	Wiper/Washer	Purple	Carded	1 Pc./Card
<b>23247</b>	Wiper/Washer	Red	Carded	1 Pc./Card
<b>23248</b>	Wiper/Washer	Silver	Carded	1 Pc./Card



23249



23216



23210



23204



23247



23254

### Chrome Dash Knob - Aluminum Sticker

#### DESCRIPTION

- Small Chrome Knob with Aluminum Sticker, Hex Screw Mount
- Available with 5 Different Scripts in 6 Different Colors

Item #	Script	Sticker Color	Package	Pack
23255	Fan/Air	Black	Carded	1 Pc./Card
23256	Fan/Air	Blue	Carded	1 Pc./Card
23257	Fan/Air	Green	Carded	1 Pc./Card
23258	Fan/Air	Purple	Carded	1 Pc./Card
23259	Fan/Air	Red	Carded	1 Pc./Card
23260	Fan/Air	Silver	Carded	1 Pc./Card
23042	Panel Lights	Black	Carded	1 Pc./Card
23043	Panel Lights	Blue	Carded	1 Pc./Card
23044	Panel Lights	Green	Carded	1 Pc./Card
23046	Panel Lights	Purple	Carded	1 Pc./Card
23045	Panel Lights	Red	Carded	1 Pc./Card
23047	Panel Lights	Silver	Carded	1 Pc./Card
23036	Washer	Black	Carded	1 Pc./Card
23037	Washer	Blue	Carded	1 Pc./Card
23038	Washer	Green	Carded	1 Pc./Card
23039	Washer	Purple	Carded	1 Pc./Card
23040	Washer	Red	Carded	1 Pc./Card
23041	Washer	Silver	Carded	1 Pc./Card
23030	Wiper	Black	Carded	1 Pc./Card
23031	Wiper	Blue	Carded	1 Pc./Card
23032	Wiper	Green	Carded	1 Pc./Card
23034	Wiper	Purple	Carded	1 Pc./Card
23033	Wiper	Red	Carded	1 Pc./Card
23035	Wiper	Silver	Carded	1 Pc./Card
23048	Wiper/Washer	Black	Carded	1 Pc./Card
23049	Wiper/Washer	Blue	Carded	1 Pc./Card
23050	Wiper/Washer	Green	Carded	1 Pc./Card
23052	Wiper/Washer	Purple	Carded	1 Pc./Card
23051	Wiper/Washer	Red	Carded	1 Pc./Card
23053	Wiper/Washer	Silver	Carded	1 Pc./Card



### Chrome Dash Knob - Stainless Steel Plaque

#### DESCRIPTION

- Small Chrome Knob with Stainless Steel Plaque, Hex Screw Mount
- Available with 6 Different Scripts

Item #	Script	Plaque	Package	Pack
23530	Dimmer	Stainless	Carded	1 Pc./Card
23532	Panel Lights	Stainless	Carded	1 Pc./Card
23533	Washer	Stainless	Carded	1 Pc./Card
23534	Wiper	Stainless	Carded	1 Pc./Card
23535	Wiper/Washer	Stainless	Carded	1 Pc./Card



### Wood Deluxe Dash Knob - Knob Only

#### DESCRIPTION

- Small Wood Deluxe Dash Knob with Grooves for Stickers
- Sticker Not Included, Hex Screw Mount

Item #	Description	Package	Pack
23378-1P	Wood Knob	Carded	1 Pc./Card
23378-1	Wood Knob	Bulk	1 Pc.



### Chrome Deluxe Knob - Glossy Maltese Cross Sticker

#### DESCRIPTION

- Small Chrome Deluxe Dash Knob with Glossy Maltese Cross Sticker
- Hex Screw Mount, Universal Application
- Available in 4 Different Scripts in 6 Different Colors

Item #	Script	Sticker Color	Package	Pack
23630	Fan/Air	Black	Carded	1 Pc./Card
23631	Fan/Air	Blue	Carded	1 Pc./Card
23632	Fan/Air	Green	Carded	1 Pc./Card
23633	Fan/Air	Purple	Carded	1 Pc./Card
23634	Fan/Air	Red	Carded	1 Pc./Card
23635	Fan/Air	Silver	Carded	1 Pc./Card
23636	Lights	Black	Carded	1 Pc./Card
23637	Lights	Blue	Carded	1 Pc./Card
23638	Lights	Green	Carded	1 Pc./Card
23639	Lights	Purple	Carded	1 Pc./Card
23640	Lights	Red	Carded	1 Pc./Card
23641	Lights	Silver	Carded	1 Pc./Card
23642	Washer	Black	Carded	1 Pc./Card
23643	Washer	Blue	Carded	1 Pc./Card
23644	Washer	Green	Carded	1 Pc./Card
23645	Washer	Purple	Carded	1 Pc./Card
23646	Washer	Red	Carded	1 Pc./Card
23647	Washer	Silver	Carded	1 Pc./Card
23648	Wiper	Black	Carded	1 Pc./Card
23649	Wiper	Blue	Carded	1 Pc./Card
23650	Wiper	Green	Carded	1 Pc./Card
23651	Wiper	Purple	Carded	1 Pc./Card
23652	Wiper	Red	Carded	1 Pc./Card
23653	Wiper	Silver	Carded	1 Pc./Card



**Wood Deluxe Dash Knob - Glossy Sticker**

DESCRIPTION

- Small Wood Deluxe Dash Knob with Glossy Sticker, Hex Screw Mount
- Available with 5 Different Scripts in 6 Different Colors

Item #	Script	Sticker Color	Package	Pack
23536	Fan/Air	Black	Carded	1 Pc./Card
23537	Fan/Air	Blue	Carded	1 Pc./Card
23538	Fan/Air	Green	Carded	1 Pc./Card
23539	Fan/Air	Purple	Carded	1 Pc./Card
23540	Fan/Air	Red	Carded	1 Pc./Card
23541	Fan/Air	Silver	Carded	1 Pc./Card
23542	Panel Lights	Black	Carded	1 Pc./Card
23543	Panel Lights	Blue	Carded	1 Pc./Card
23545	Panel Lights	Purple	Carded	1 Pc./Card
23546	Panel Lights	Red	Carded	1 Pc./Card
23547	Panel Lights	Silver	Carded	1 Pc./Card
23548	Washer	Black	Carded	1 Pc./Card
23549	Washer	Blue	Carded	1 Pc./Card
23550	Washer	Green	Carded	1 Pc./Card
23551	Washer	Purple	Carded	1 Pc./Card
23552	Washer	Red	Carded	1 Pc./Card
23553	Washer	Silver	Carded	1 Pc./Card
23554	Wiper	Black	Carded	1 Pc./Card
23555	Wiper	Blue	Carded	1 Pc./Card
23556	Wiper	Green	Carded	1 Pc./Card
23557	Wiper	Purple	Carded	1 Pc./Card
23558	Wiper	Red	Carded	1 Pc./Card
23559	Wiper	Silver	Carded	1 Pc./Card
23560	Wiper/Washer	Black	Carded	1 Pc./Card
23561	Wiper/Washer	Blue	Carded	1 Pc./Card
23562	Wiper/Washer	Green	Carded	1 Pc./Card
23563	Wiper/Washer	Purple	Carded	1 Pc./Card
23564	Wiper/Washer	Red	Carded	1 Pc./Card
23565	Wiper/Washer	Silver	Carded	1 Pc./Card



23536



23543



23550



23557



23564



23541

**Wood Deluxe Dash Knob - Aluminum Sticker**

DESCRIPTION

- Small Wood Deluxe Knob with Aluminum Sticker, Hex Screw Mount
- Available with 5 Different Scripts in 6 Different Colors

Item #	Script	Sticker Color	Package	Pack
23566	Fan/Air	Black	Carded	1 Pc./Card
23567	Fan/Air	Blue	Carded	1 Pc./Card
23568	Fan/Air	Green	Carded	1 Pc./Card
23569	Fan/Air	Purple	Carded	1 Pc./Card
23570	Fan/Air	Red	Carded	1 Pc./Card
23571	Fan/Air	Silver	Carded	1 Pc./Card
23572	Panel Lights	Black	Carded	1 Pc./Card
23573	Panel Lights	Blue	Carded	1 Pc./Card
23574	Panel Lights	Green	Carded	1 Pc./Card
23575	Panel Lights	Purple	Carded	1 Pc./Card
23576	Panel Lights	Red	Carded	1 Pc./Card
23577	Panel Lights	Silver	Carded	1 Pc./Card
23588	Washer	Black	Carded	1 Pc./Card
23589	Washer	Blue	Carded	1 Pc./Card
23590	Washer	Green	Carded	1 Pc./Card
23591	Washer	Purple	Carded	1 Pc./Card
23592	Washer	Red	Carded	1 Pc./Card
23593	Washer	Silver	Carded	1 Pc./Card
23594	Wiper	Black	Carded	1 Pc./Card
23595	Wiper	Blue	Carded	1 Pc./Card
23596	Wiper	Green	Carded	1 Pc./Card
23597	Wiper	Purple	Carded	1 Pc./Card
23598	Wiper	Red	Carded	1 Pc./Card
23599	Wiper	Silver	Carded	1 Pc./Card
23600	Wiper/Washer	Black	Carded	1 Pc./Card
23601	Wiper/Washer	Blue	Carded	1 Pc./Card
23602	Wiper/Washer	Green	Carded	1 Pc./Card
23603	Wiper/Washer	Purple	Carded	1 Pc./Card
23604	Wiper/Washer	Red	Carded	1 Pc./Card
23605	Wiper/Washer	Silver	Carded	1 Pc./Card



23566



23589



23568



23575



23576



23605

**Wood Deluxe Dash Knob - Stainless Steel Plaque**

## DESCRIPTION

- Small Wood Knob with Stainless Steel Plaque, Hex Screw Mount
- Available with 5 Different Scripts

Item #	Script	Plaque	Package	Pack
<b>23384</b>	Dimmer	Stainless	Carded	1 Pc./Card
<b>23380</b>	Panel Lights	Stainless	Carded	1 Pc./Card
<b>23379</b>	Washer	Stainless	Carded	1 Pc./Card
<b>23378</b>	Wiper	Stainless	Carded	1 Pc./Card
<b>23381</b>	Wiper/Washer	Stainless	Carded	1 Pc./Card

**Glossy Maltese Cross Sticker - Sticker Only**

## DESCRIPTION

- Glossy Maltese Cross Sticker for Dash Knobs, Sticker Only
- Available with 4 Different Scripts in 6 Different Colors

Item #	Script	Sticker Color	Package	Pack
<b>23249-2K</b>	Fan/Air	Black	Bulk	1 Pc.
<b>23249-2B</b>	Fan/Air	Blue	Bulk	1 Pc.
<b>23249-2G</b>	Fan/Air	Green	Bulk	1 Pc.
<b>23249-2P</b>	Fan/Air	Purple	Bulk	1 Pc.
<b>23249-2R</b>	Fan/Air	Red	Bulk	1 Pc.
<b>23249-2S</b>	Fan/Air	Silver	Bulk	1 Pc.
<b>23215-2K</b>	Lights	Black	Bulk	1 Pc.
<b>23215-2B</b>	Lights	Blue	Bulk	1 Pc.
<b>23215-2G</b>	Lights	Green	Bulk	1 Pc.
<b>23215-2P</b>	Lights	Purple	Bulk	1 Pc.
<b>23215-2R</b>	Lights	Red	Bulk	1 Pc.
<b>23215-2S</b>	Lights	Silver	Bulk	1 Pc.
<b>23208-2K</b>	Washer	Black	Bulk	1 Pc.
<b>23208-2B</b>	Washer	Blue	Bulk	1 Pc.
<b>23208-2G</b>	Washer	Green	Bulk	1 Pc.
<b>23208-2P</b>	Washer	Purple	Bulk	1 Pc.
<b>23208-2R</b>	Washer	Red	Bulk	1 Pc.
<b>23208-2S</b>	Washer	Silver	Bulk	1 Pc.
<b>23201-2K</b>	Wiper	Black	Bulk	1 Pc.
<b>23201-2B</b>	Wiper	Blue	Bulk	1 Pc.
<b>23201-2G</b>	Wiper	Green	Bulk	1 Pc.
<b>23201-2P</b>	Wiper	Purple	Bulk	1 Pc.
<b>23201-2R</b>	Wiper	Red	Bulk	1 Pc.
<b>23201-2S</b>	Wiper	Silver	Bulk	1 Pc.



23249-2K



23215-2B



23249-2R



23215-2S

**Glossy Sticker - Sticker Only**

## DESCRIPTION

- Glossy Sticker for Dash Knobs, Sticker Only
- Available with 5 Different Scripts in 6 Different Colors

Item #	Script	Sticker Color	Package	Pack
<b>23249-1K</b>	Fan/Air	Black	Bulk	1 Pc.
<b>23249-1B</b>	Fan/Air	Blue	Bulk	1 Pc.
<b>23249-1G</b>	Fan/Air	Green	Bulk	1 Pc.
<b>23249-1P</b>	Fan/Air	Purple	Bulk	1 Pc.
<b>23249-1R</b>	Fan/Air	Red	Bulk	1 Pc.
<b>23249-1S</b>	Fan/Air	Silver	Bulk	1 Pc.
<b>23215-1K</b>	Panel Lights	Black	Bulk	1 Pc.
<b>23215-1B</b>	Panel Lights	Blue	Bulk	1 Pc.
<b>23215-1G</b>	Panel Lights	Green	Bulk	1 Pc.
<b>23215-1P</b>	Panel Lights	Purple	Bulk	1 Pc.
<b>23215-1R</b>	Panel Lights	Red	Bulk	1 Pc.
<b>23215-1S</b>	Panel Lights	Silver	Bulk	1 Pc.
<b>23208-1K</b>	Washer	Black	Bulk	1 Pc.
<b>23208-1B</b>	Washer	Blue	Bulk	1 Pc.
<b>23208-1G</b>	Washer	Green	Bulk	1 Pc.
<b>23208-1P</b>	Washer	Purple	Bulk	1 Pc.
<b>23208-1R</b>	Washer	Red	Bulk	1 Pc.
<b>23208-1S</b>	Washer	Silver	Bulk	1 Pc.
<b>23201-1K</b>	Wiper	Black	Bulk	1 Pc.
<b>23201-1B</b>	Wiper	Blue	Bulk	1 Pc.
<b>23201-1G</b>	Wiper	Green	Bulk	1 Pc.
<b>23201-1P</b>	Wiper	Purple	Bulk	1 Pc.
<b>23201-1R</b>	Wiper	Red	Bulk	1 Pc.
<b>23201-1S</b>	Wiper	Silver	Bulk	1 Pc.
<b>23243-1K</b>	Wiper/Washer	Black	Bulk	1 Pc.
<b>23243-1B</b>	Wiper/Washer	Blue	Bulk	1 Pc.
<b>23243-1G</b>	Wiper/Washer	Green	Bulk	1 Pc.
<b>23243-1P</b>	Wiper/Washer	Purple	Bulk	1 Pc.
<b>23243-1R</b>	Wiper/Washer	Red	Bulk	1 Pc.
<b>23243-1S</b>	Wiper/Washer	Silver	Bulk	1 Pc.



23249-1K



23215-1B



23201-1G

### Aluminum Sticker - Sticker Only

DESCRIPTION

- Aluminum Sticker for Dash Knobs, Sticker Only
- Available with 5 Different Scripts in 6 Different Colors

Item #	Script	Sticker Color	Package	Pack
23030-8K	Fan/Air	Black	Bulk	1 Pc.
23030-8B	Fan/Air	Blue	Bulk	1 Pc.
23030-8G	Fan/Air	Green	Bulk	1 Pc.
23030-8P	Fan/Air	Purple	Bulk	1 Pc.
23030-8R	Fan/Air	Red	Bulk	1 Pc.
23030-8S	Fan/Air	Silver	Bulk	1 Pc.
23030-4K	Panel Lights	Black	Bulk	1 Pc.
23030-4B	Panel Lights	Blue	Bulk	1 Pc.
23030-4G	Panel Lights	Green	Bulk	1 Pc.
23030-4P	Panel Lights	Purple	Bulk	1 Pc.
23030-4R	Panel Lights	Red	Bulk	1 Pc.
23030-4S	Panel Lights	Silver	Bulk	1 Pc.
23030-3K	Washer	Black	Bulk	1 Pc.
23030-3B	Washer	Blue	Bulk	1 Pc.
23030-3G	Washer	Green	Bulk	1 Pc.
23030-3P	Washer	Purple	Bulk	1 Pc.
23030-3R	Washer	Red	Bulk	1 Pc.
23030-3S	Washer	Silver	Bulk	1 Pc.
23030-2K	Wiper	Black	Bulk	1 Pc.
23030-2B	Wiper	Blue	Bulk	1 Pc.
23030-2G	Wiper	Green	Bulk	1 Pc.
23030-2P	Wiper	Purple	Bulk	1 Pc.
23030-2R	Wiper	Red	Bulk	1 Pc.
23030-2S	Wiper	Silver	Bulk	1 Pc.
23030-5K	Wiper/Washer	Black	Bulk	1 Pc.
23030-5B	Wiper/Washer	Blue	Bulk	1 Pc.
23030-5G	Wiper/Washer	Green	Bulk	1 Pc.
23030-5P	Wiper/Washer	Purple	Bulk	1 Pc.
23030-5R	Wiper/Washer	Red	Bulk	1 Pc.
23030-5S	Wiper/Washer	Silver	Bulk	1 Pc.



23030-8K



23030-4B



23030-3G



23030-2P



23030-5R



23030-8G

### Stainless Steel Plaque - Plaque Only

DESCRIPTION

- Stainless Steel Plaque for Dash Knobs, Plaque Only
- Available with 5 Different Scripts

Item #	Script	Plaque	Package	Pack
23378-7	Dimmer	Stainless	Bulk	1 Pc.
23378-3	Panel Lights	Stainless	Bulk	1 Pc.
23378-4	Washer	Stainless	Bulk	1 Pc.
23378-5	Wiper	Stainless	Bulk	1 Pc.
23378-6	Wiper/Washer	Stainless	Bulk	1 Pc.



23378-3



23378-6

## New & Hot

### Deluxe Air Valve Knobs - Military Medallion

DESCRIPTION

- Deluxe Air Valve Knob with U.S. Military Metal Medallion

Item #	Description	Package	Pack
22960	Air Force	Carded	1 Pc./Card
22961	Army	Carded	1 Pc./Card
22962	Navy	Carded	1 Pc./Card
22963	Marine	Carded	1 Pc./Card



22960



22961



22962



22963



# AIR VALVE KNOBS

## Dagger Air Valve Knob

### DESCRIPTION

- Aluminum Screw-On Air Valve Knob
- Available in Chrome or Black Finish

Item #	Style	Finish	Package	Pack
<b>23525</b>	Plain	Chrome	Carded	1 Pc./Card
<b>23529</b>	Plain	Black	Carded	1 Pc./Card
<b>23578</b>	Skull	Chrome	Carded	1 Pc./Card
<b>23579</b>	Skull	Black	Carded	1 Pc./Card



## Skull Air Valve Knob

### DESCRIPTION

- Skull Screw-On Air Valve Knob
- Available in Chrome or Black Finished

Item #	Style	Finish	Package	Pack
<b>23058</b>	Skull	Chrome	Carded	1 Pc./Card
<b>23054</b>	Skull	Black	Carded	1 Pc./Card



## Air Valve Adapter

### DESCRIPTION

- Chrome Aluminum Screw-On Air Valve Adapter
- For Use with United Pacific Custom Chrome Grips
- Patent Pending

Item #	Description	Package	Pack
<b>23008B</b>	Air Valve Adapter	Bulk	1 Pc.



## Designer Grip

### DESCRIPTION

- Aluminum Replacement "Designer" Grip for UP Shift Knobs
- CNC-Machined Grip, 1" Round Opening, Hex Screw Mount
- Mounting Adapter (Item # 70600B & # 70604B) Available Separately

Item #	Description	Package	Pack
<b>70691</b>	Black "Daytona" Spike Grip	Bulk	1 Pc./Bulk
<b>70645B</b>	"Austin" Gun Cylinder Grip	Bulk	1 Pc./Bulk
<b>70644B</b>	"Brooklyn" Spike Grip	Bulk	1 Pc./Bulk
<b>70622B</b>	"Dallas" Grooved Grip	Bulk	1 Pc./Bulk
<b>70601B</b>	"Daytona" Spike Grip	Bulk	1 Pc./Bulk
<b>70621B</b>	"Talladega" Spike Grip	Bulk	1 Pc./Bulk
<b>70602B</b>	"Vegas" Grooved Grip	Bulk	1 Pc./Bulk





### Designer Air Valve Knob

DESCRIPTION

- Designer Screw-On Air Valve Knob in 7 Unique Designs
- CNC-Machined Grip
- Mounting Adapter Available Separately: Item # 23008B

Item #	Description	Package	Pack
<b>23016</b>	Black "Daytona" Spike Air Valve Knob	Carded	1 Pc./Card
<b>23090</b>	"Austin" Air Valve Knob	Carded	1 Pc./Card
<b>23091</b>	"Brooklyn" Air Valve Knob	Carded	1 Pc./Card
<b>23068</b>	"Dallas" Air Valve Knob	Carded	1 Pc./Card
<b>23066</b>	"Daytona" Air Valve Knob	Carded	1 Pc./Card
<b>23069</b>	"Talladega" Air Valve Knob	Carded	1 Pc./Card
<b>23067</b>	"Vegas" Air Valve Knob	Carded	1 Pc./Card



### Chrome "Brass Knuckle" Air Valve Knob

DESCRIPTION

- Chrome Aluminum Screw-On "Brass Knuckle" Air Valve Knob
- Unique Scripted Design, Please Specify Tractor or Trailer Knob

Item #	Description	Package	Pack
<b>23526</b>	Tractor Air Valve Knob	Carded	1 Pc./Card
<b>23527</b>	Trailer Air Valve Knob	Carded	1 Pc./Card



### Chrome "Grenade" Air Valve Knob

DESCRIPTION

- Chrome Aluminum "Grenade" Air Valve Knob for Kenworth
- Includes Stainless Steel Laser Etched "Tractor" or "Trailer" Clip
- Patent Pending

Item #	Description	Package	Pack
<b>23508</b>	Tractor Air Valve Knob	Carded	1 Pc./Card
<b>23509</b>	Trailer Air Valve Knob	Carded	1 Pc./Card



### Chrome "USMC Fighting Knife" Air Valve Knob

DESCRIPTION

- Chrome Aluminum "USMC Fighting Knife" Air Valve Knob
- Based on the Famous "KA-BAR" Fighting Knife Used by the US Army Forces in Numerous Wars and Conflicts, the Knife that Won WWII
- Patent Pending

Item #	Description	Package	Pack
<b>23528</b>	USMC Air Valve Knob	Carded	1 Pc./Card

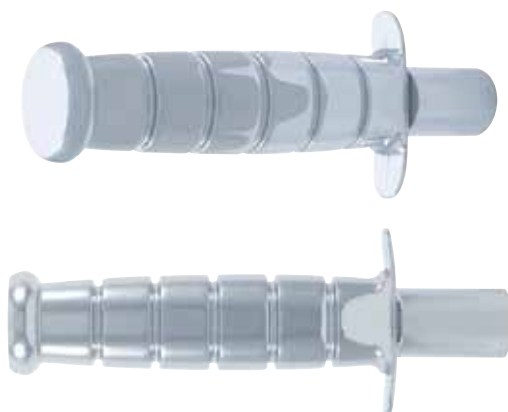

**Chrome Designer Air Valve Knob**

## DESCRIPTION

- Chrome Aluminum Screw-On Air Valve Knob
- Available in Gun Cylinder or Keg Style

Item #	Description	Package	Pack
<b>23399</b>	Gun Cylinder Knob	Carded	1 Pc./Card
<b>23389</b>	Keg Air Valve Cover	Carded	1 Pc./Card



23399



23389

**Chrome Maltese Cross Air Valve Knob**

## DESCRIPTION

- Chrome Aluminum Air Valve Knob with Chrome Plastic Maltese Cross Cover
- Maltese Cross Cover Snaps onto the Air Valve Knob

Item #	Description	Package	Pack
<b>23057</b>	Cross Air Valve Knob	Carded	1 Pc./Card

**Chrome Maltese Cross Air Valve Cover**

## DESCRIPTION

- Chrome Plastic Maltese Cross Air Valve Knob Cover
- Snaps onto United Pacific Air Valve Knob Only (UP Item # 23010-1)

Item #	Description	Package	Pack
<b>23055</b>	Cross Air Valve Cover	Carded	1 Pc./Card

**Chrome Deluxe Air Valve Knob - Indented**

## DESCRIPTION

- Chrome Aluminum Deluxe Screw-On Indented Air Valve Knob

Item #	Description	Package	Pack
<b>23370B</b>	Deluxe Air Valve Knob	Carded	1 Pc./Card

**Chrome Deluxe Air Valve "Tractor" Knob - Diamond**

## DESCRIPTION

- Chrome Aluminum Deluxe Screw-On Air Valve Knob with Diamond and Plaque
- Available with 6 Different Color Diamonds
- Stainless Tractor Plaque Available Separately, Item # 23522

Item #	Script	Diamond	Package	Pack
<b>23510</b>	Tractor	Amber	Carded	1 Pc./Card
<b>23511</b>	Tractor	Blue	Carded	1 Pc./Card
<b>23512</b>	Tractor	Clear	Carded	1 Pc./Card
<b>23513</b>	Tractor	Green	Carded	1 Pc./Card
<b>23514</b>	Tractor	Purple	Carded	1 Pc./Card
<b>23515</b>	Tractor	Red	Carded	1 Pc./Card



23510



23511



23512

**Chrome Deluxe Air Valve "Trailer" Knob - Diamond**

## DESCRIPTION

- Chrome Aluminum Deluxe Screw-On Air Valve Knob with Diamond and Plaque
- Available with 6 Different Color Diamonds
- Stainless Trailer Plaque Available Separately, Item # 23523

Item #	Script	Diamond	Package	Pack
<b>23516</b>	Trailer	Amber	Carded	1 Pc./Card
<b>23517</b>	Trailer	Blue	Carded	1 Pc./Card
<b>23518</b>	Trailer	Clear	Carded	1 Pc./Card
<b>23519</b>	Trailer	Green	Carded	1 Pc./Card
<b>23520</b>	Trailer	Purple	Carded	1 Pc./Card
<b>23521</b>	Trailer	Red	Carded	1 Pc./Card



23519



23520



23521

### Chrome Deluxe Air Valve Knob

DESCRIPTION

- Chrome Aluminum Deluxe Screw On Air Valve Knob, Knob Only

Item #	Description	Package	Pack
<b>23385</b>	Deluxe Air Valve Knob	Carded	1 Pc./Card
<b>23385B</b>	Deluxe Air Valve Knob	Bulk	1 Pc.



### Chrome Deluxe Air Valve Knob - Glossy Cross Sticker

DESCRIPTION

- Large Chrome Deluxe Air Valve Knob with Glossy Maltese Cross Sticker  
 - Available with 2 Different Scripts in 5 Different Colors, Screw-On

Item #	Script	Sticker Color	Package	Pack
<b>23166</b>	Tractor	Black	Carded	1 Pc./Card
<b>23167</b>	Tractor	Blue	Carded	1 Pc./Card
<b>23168</b>	Tractor	Green	Carded	1 Pc./Card
<b>23169</b>	Tractor	Purple	Carded	1 Pc./Card
<b>23170</b>	Tractor	Red	Carded	1 Pc./Card
<b>23172</b>	Trailer	Black	Carded	1 Pc./Card
<b>23173</b>	Trailer	Blue	Carded	1 Pc./Card
<b>23174</b>	Trailer	Green	Carded	1 Pc./Card
<b>23175</b>	Trailer	Purple	Carded	1 Pc./Card
<b>23176</b>	Trailer	Red	Carded	1 Pc./Card



### Chrome Deluxe Air Valve Knob - Glossy Sticker

DESCRIPTION

- Large Chrome Deluxe Air Valve Knob with Glossy Sticker, Screw-On  
 - Available with 3 Different Scripts in 6 Different Colors

Item #	Script	Sticker Color	Package	Pack
<b>23400</b>	Tractor	Black	Carded	1 Pc./Card
<b>23401</b>	Tractor	Blue	Carded	1 Pc./Card
<b>23402</b>	Tractor	Green	Carded	1 Pc./Card
<b>23403</b>	Tractor	Purple	Carded	1 Pc./Card
<b>23404</b>	Tractor	Red	Carded	1 Pc./Card
<b>23405</b>	Tractor	Silver	Carded	1 Pc./Card
<b>23406</b>	Trailer	Black	Carded	1 Pc./Card
<b>23407</b>	Trailer	Blue	Carded	1 Pc./Card
<b>23408</b>	Trailer	Green	Carded	1 Pc./Card
<b>23409</b>	Trailer	Purple	Carded	1 Pc./Card
<b>23410</b>	Trailer	Red	Carded	1 Pc./Card
<b>23411</b>	Trailer	Silver	Carded	1 Pc./Card
<b>23412</b>	Emergency	Black	Carded	1 Pc./Card
<b>23413</b>	Emergency	Blue	Carded	1 Pc./Card
<b>23414</b>	Emergency	Green	Carded	1 Pc./Card
<b>23415</b>	Emergency	Purple	Carded	1 Pc./Card
<b>23416</b>	Emergency	Red	Carded	1 Pc./Card



### Chrome Deluxe Air Valve Knob - Aluminum Sticker

#### DESCRIPTION

- Large Deluxe Chrome Air Valve Knob with Aluminum Sticker
- Available with 3 Different Scripts in 6 Different Colors, Screw-On

Item #	Script	Sticker Color	Package	Pack
23418	Tractor	Black	Carded	1 Pc./Card
23419	Tractor	Blue	Carded	1 Pc./Card
23420	Tractor	Green	Carded	1 Pc./Card
23421	Tractor	Purple	Carded	1 Pc./Card
23422	Tractor	Red	Carded	1 Pc./Card
23423	Tractor	Silver	Carded	1 Pc./Card
23424	Trailer	Black	Carded	1 Pc./Card
23425	Trailer	Blue	Carded	1 Pc./Card
23426	Trailer	Green	Carded	1 Pc./Card
23427	Trailer	Purple	Carded	1 Pc./Card
23428	Trailer	Red	Carded	1 Pc./Card
23429	Trailer	Silver	Carded	1 Pc./Card
23430	Emergency	Black	Carded	1 Pc./Card
23431	Emergency	Blue	Carded	1 Pc./Card
23432	Emergency	Green	Carded	1 Pc./Card
23433	Emergency	Purple	Carded	1 Pc./Card
23434	Emergency	Red	Carded	1 Pc./Card
23435	Emergency	Silver	Carded	1 Pc./Card



### Chrome Deluxe Air Valve Knob - Stainless Steel Plaque

#### DESCRIPTION

- Large Chrome Air Valve Knob with Stainless Steel Plaque, Screw-On

Item #	Script	Script Style	Package	Pack
23386	Tractor	Cursive	Carded	1 Pc./Card
23387	Trailer	Cursive	Carded	1 Pc./Card



### Chrome Air Valve Knob

#### DESCRIPTION

- Large Chrome Aluminum Screw On Air Valve Knob, Knob Only

Item #	Description	Package	Pack
23010-1P	Air Valve Knob	Carded	1 Pc./Card
23010-1	Air Valve Knob	Bulk	1 Pc.



### Chrome Air Valve Knob - Glossy Cross Sticker

#### DESCRIPTION

- Large Chrome Air Valve Knob with Glossy Maltese Cross Sticker
- Available with 2 Different Scripts in 6 Different Colors, Screw-On

Item #	Script	Sticker Color	Package	Pack
23654	Tractor	Black	Carded	1 Pc./Card
23655	Tractor	Blue	Carded	1 Pc./Card
23656	Tractor	Green	Carded	1 Pc./Card
23657	Tractor	Purple	Carded	1 Pc./Card
23658	Tractor	Red	Carded	1 Pc./Card
23660	Trailer	Black	Carded	1 Pc./Card
23661	Trailer	Blue	Carded	1 Pc./Card
23662	Trailer	Green	Carded	1 Pc./Card
23663	Trailer	Purple	Carded	1 Pc./Card
23664	Trailer	Red	Carded	1 Pc./Card



### Chrome Air Valve Knob - Glossy Sticker

DESCRIPTION

- Large Chrome Air Valve Knob with Glossy Sticker
- Available with 3 Different Scripts in 6 Different Colors, Screw-On

Item #	Script	Sticker Color	Package	Pack
23222	Tractor	Black	Carded	1 Pc./Card
23223	Tractor	Blue	Carded	1 Pc./Card
23224	Tractor	Green	Carded	1 Pc./Card
23225	Tractor	Purple	Carded	1 Pc./Card
23226	Tractor	Red	Carded	1 Pc./Card
23227	Tractor	Silver	Carded	1 Pc./Card
23229	Trailer	Black	Carded	1 Pc./Card
23230	Trailer	Blue	Carded	1 Pc./Card
23231	Trailer	Green	Carded	1 Pc./Card
23232	Trailer	Purple	Carded	1 Pc./Card
23233	Trailer	Red	Carded	1 Pc./Card
23234	Trailer	Silver	Carded	1 Pc./Card
23236	Emergency	Black	Carded	1 Pc./Card
23237	Emergency	Blue	Carded	1 Pc./Card
23238	Emergency	Green	Carded	1 Pc./Card
23239	Emergency	Purple	Carded	1 Pc./Card
23240	Emergency	Red	Carded	1 Pc./Card



23222



23233



23234



23238



### Chrome Air Valve Knob - Aluminum Sticker

DESCRIPTION

- Large Chrome Air Valve Knob with Aluminum Sticker, Screw-On
- Available with 3 Different Scripts in 6 Different Colors

Item #	Script	Sticker Color	Package	Pack
23010	Tractor	Black	Carded	1 Pc./Card
23011	Tractor	Blue	Carded	1 Pc./Card
23012	Tractor	Green	Carded	1 Pc./Card
23013	Tractor	Purple	Carded	1 Pc./Card
23014	Tractor	Red	Carded	1 Pc./Card
23015	Tractor	Silver	Carded	1 Pc./Card
23017	Trailer	Black	Carded	1 Pc./Card
23018	Trailer	Blue	Carded	1 Pc./Card
23019	Trailer	Green	Carded	1 Pc./Card
23020	Trailer	Purple	Carded	1 Pc./Card
23021	Trailer	Red	Carded	1 Pc./Card
23022	Trailer	Silver	Carded	1 Pc./Card
23024	Emergency	Black	Carded	1 Pc./Card
23025	Emergency	Blue	Carded	1 Pc./Card
23026	Emergency	Green	Carded	1 Pc./Card
23027	Emergency	Purple	Carded	1 Pc./Card
23028	Emergency	Red	Carded	1 Pc./Card
23029	Emergency	Silver	Carded	1 Pc./Card



23013



23017



23025

### Chrome Air Valve Knob - Stainless Steel Plaque

DESCRIPTION

- Large Chrome Air Valve Knob with Stainless Steel Plaque, Screw-On

Item #	Script	Script Style	Package	Pack
23364	Tractor	Cursive	Carded	1 Pc./Card
23365	Trailer	Cursive	Carded	1 Pc./Card



23364



23365

**Chrome 3" Air Valve Knob**

DESCRIPTION

- Chrome 3" Aluminum Screw-On Air Valve Knob, Knob Only

Item #	Description	Package	Pack
<b>23360</b>	3" Air Valve Knob	Carded	1 Pc./Card



**Chrome 3" Air Valve Knob - Glossy Cross Sticker**

DESCRIPTION

- Chrome 3" Aluminum Air Valve Knob with Glossy Cross Sticker  
 - Available with 2 Different Scripts in 5 Different Colors, Screw-On

Item #	Script	Sticker Color	Package	Pack
<b>23712</b>	Tractor	Black	Carded	1 Pc./Card
<b>23713</b>	Tractor	Blue	Carded	1 Pc./Card
<b>23714</b>	Tractor	Green	Carded	1 Pc./Card
<b>23715</b>	Tractor	Purple	Carded	1 Pc./Card
<b>23716</b>	Tractor	Red	Carded	1 Pc./Card
<b>23718</b>	Trailer	Black	Carded	1 Pc./Card
<b>23719</b>	Trailer	Blue	Carded	1 Pc./Card
<b>23720</b>	Trailer	Green	Carded	1 Pc./Card
<b>23721</b>	Trailer	Purple	Carded	1 Pc./Card
<b>23722</b>	Trailer	Red	Carded	1 Pc./Card



**Chrome 3" Air Valve Knob - Glossy Sticker**

DESCRIPTION

- Chrome 3" Air Valve Knob with Sticker, Screw-On  
 - Available with 3 Different Scripts in 6 Different Colors

Item #	Script	Sticker Color	Package	Pack
<b>23724</b>	Tractor	Black	Carded	1 Pc./Card
<b>23725</b>	Tractor	Blue	Carded	1 Pc./Card
<b>23726</b>	Tractor	Green	Carded	1 Pc./Card
<b>23727</b>	Tractor	Purple	Carded	1 Pc./Card
<b>23728</b>	Tractor	Red	Carded	1 Pc./Card
<b>23729</b>	Tractor	Silver	Carded	1 Pc./Card
<b>23730</b>	Trailer	Black	Carded	1 Pc./Card
<b>23731</b>	Trailer	Blue	Carded	1 Pc./Card
<b>23732</b>	Trailer	Green	Carded	1 Pc./Card
<b>23733</b>	Trailer	Purple	Carded	1 Pc./Card
<b>23734</b>	Trailer	Red	Carded	1 Pc./Card
<b>23735</b>	Trailer	Silver	Carded	1 Pc./Card
<b>23736</b>	Emergency	Black	Carded	1 Pc./Card
<b>23737</b>	Emergency	Blue	Carded	1 Pc./Card
<b>23738</b>	Emergency	Green	Carded	1 Pc./Card
<b>23739</b>	Emergency	Purple	Carded	1 Pc./Card
<b>23740</b>	Emergency	Red	Carded	1 Pc./Card



### Chrome 3" Air Valve Knob - Aluminum Sticker

DESCRIPTION

- Chrome 3" Air Valve Knob with Aluminum Sticker, Screw-On
- Available with 3 Different Scripts in 6 Different Colors

Item #	Script	Sticker Color	Package	Pack
<b>23742</b>	Tractor	Black	Carded	1 Pc./Card
<b>23743</b>	Tractor	Blue	Carded	1 Pc./Card
<b>23744</b>	Tractor	Green	Carded	1 Pc./Card
<b>23745</b>	Tractor	Purple	Carded	1 Pc./Card
<b>23746</b>	Tractor	Red	Carded	1 Pc./Card
<b>23747</b>	Tractor	Silver	Carded	1 Pc./Card
<b>23748</b>	Trailer	Black	Carded	1 Pc./Card
<b>23749</b>	Trailer	Blue	Carded	1 Pc./Card
<b>23750</b>	Trailer	Green	Carded	1 Pc./Card
<b>23751</b>	Trailer	Purple	Carded	1 Pc./Card
<b>23752</b>	Trailer	Red	Carded	1 Pc./Card
<b>23753</b>	Trailer	Silver	Carded	1 Pc./Card
<b>23754</b>	Emergency	Black	Carded	1 Pc./Card
<b>23755</b>	Emergency	Blue	Carded	1 Pc./Card
<b>23756</b>	Emergency	Green	Carded	1 Pc./Card
<b>23757</b>	Emergency	Purple	Carded	1 Pc./Card
<b>23758</b>	Emergency	Red	Carded	1 Pc./Card
<b>23759</b>	Emergency	Silver	Carded	1 Pc./Card



### Chrome 3" Air Valve Knob - Stainless Steel Plaque

DESCRIPTION

- Chrome 3" Aluminum Screw-On Air Valve Knob with Stainless Steel Plaque

Item #	Script	Script Style	Package	Pack
<b>23760</b>	Tractor	Cursive	Carded	1 Pc./Card
<b>23761</b>	Trailer	Cursive	Carded	1 Pc./Card



### Chrome Long Air Valve Knob - Pin Mount

DESCRIPTION

- Chrome Aluminum Long Pin Mount Air Valve Knobs
- Long Knob Size: 3/8" I.D. x 1 3/4" Tall

Item #	Description	Package	Pack
<b>23310-1P</b>	Air Valve Knob	Carded	1 Pc./Card
<b>23310-1</b>	Air Valve Knob	Bulk	1 Pc.



### Chrome Long Air Valve Knob - Pin Mount/Glossy Cross

DESCRIPTION

- Chrome Long Air Valve Knob with Glossy Cross Sticker
- Available with 2 Different Scripts in 5 Different Colors, Pin Mount

Item #	Script	Sticker Color	Package	Pack
<b>23669</b>	Tractor	Black	Carded	1 Pc./Card
<b>23670</b>	Tractor	Blue	Carded	1 Pc./Card
<b>23671</b>	Tractor	Green	Carded	1 Pc./Card
<b>23672</b>	Tractor	Purple	Carded	1 Pc./Card
<b>23673</b>	Tractor	Red	Carded	1 Pc./Card
<b>23675</b>	Trailer	Black	Carded	1 Pc./Card
<b>23676</b>	Trailer	Blue	Carded	1 Pc./Card
<b>23677</b>	Trailer	Green	Carded	1 Pc./Card
<b>23678</b>	Trailer	Purple	Carded	1 Pc./Card
<b>23679</b>	Trailer	Red	Carded	1 Pc./Card



**Chrome Long Air Valve Knob - Pin Mount/Glossy**

DESCRIPTION

- Large Chrome Long Air Valve Knob with Glossy Sticker, Pin Mount
- Long Knob Size: 3/8" I.D. x 1 3/4" Tall

Item #	Script	Sticker Color	Package	Pack
23334	Tractor	Black	Carded	1 Pc./Card
23335	Tractor	Blue	Carded	1 Pc./Card
23336	Tractor	Green	Carded	1 Pc./Card
23337	Tractor	Purple	Carded	1 Pc./Card
23338	Tractor	Red	Carded	1 Pc./Card
23339	Tractor	Silver	Carded	1 Pc./Card
23342	Trailer	Black	Carded	1 Pc./Card
23343	Trailer	Blue	Carded	1 Pc./Card
23344	Trailer	Green	Carded	1 Pc./Card
23345	Trailer	Purple	Carded	1 Pc./Card
23346	Trailer	Red	Carded	1 Pc./Card
23347	Trailer	Silver	Carded	1 Pc./Card
23350	Emergency	Black	Carded	1 Pc./Card
23351	Emergency	Blue	Carded	1 Pc./Card
23352	Emergency	Green	Carded	1 Pc./Card
23353	Emergency	Purple	Carded	1 Pc./Card
23354	Emergency	Red	Carded	1 Pc./Card



23334



23343



23354

Size Comparison Chart



23310-1 Long Knob



23264-1 Short Knob

**Chrome Long Air Valve Knob - Pin Mount/Aluminum**

DESCRIPTION

- Large Chrome Long Air Valve Knob with Aluminum Sticker, Pin Mount
- Long Knob Size: 3/8" I.D. x 1 3/4" Tall

Item #	Script	Sticker Color	Package	Pack
23310	Tractor	Black	Carded	1 Pc./Card
23311	Tractor	Blue	Carded	1 Pc./Card
23312	Tractor	Green	Carded	1 Pc./Card
23313	Tractor	Purple	Carded	1 Pc./Card
23314	Tractor	Red	Carded	1 Pc./Card
23315	Tractor	Silver	Carded	1 Pc./Card
23318	Trailer	Black	Carded	1 Pc./Card
23319	Trailer	Blue	Carded	1 Pc./Card
23320	Trailer	Green	Carded	1 Pc./Card
23321	Trailer	Purple	Carded	1 Pc./Card
23322	Trailer	Red	Carded	1 Pc./Card
23323	Trailer	Silver	Carded	1 Pc./Card
23326	Emergency	Black	Carded	1 Pc./Card
23327	Emergency	Blue	Carded	1 Pc./Card
23328	Emergency	Green	Carded	1 Pc./Card
23329	Emergency	Purple	Carded	1 Pc./Card
23330	Emergency	Red	Carded	1 Pc./Card
23331	Emergency	Silver	Carded	1 Pc./Card



23314



23323

**Chrome Long Air Valve Knob - Pin Mount/Stainless**

DESCRIPTION

- Large Chrome Long Air Valve Knob with Stainless Steel Plaque, Pin Mount
- Long Knob Size: 3/8" I.D. x 1 3/4" Tall

Item #	Script	Script Style	Package	Pack
23178	Tractor	Cursive	Carded	1 Pc./Card
23179	Trailer	Cursive	Carded	1 Pc./Card



23178



23179



### Chrome Short Air Valve Knob - Pin Mount

DESCRIPTION

- Chrome Aluminum Short Pin Mount Air Valve Knobs
- Long Knob Size: 3/8" I.D. x 1 3/8" Tall

Item #	Description	Package	Pack
<b>23264-1</b>	Air Valve Knob	Carded	1 Pc./Card



### Chrome Short Air Valve Knob - Pin Mount/Glossy Cross

DESCRIPTION

- Chrome Short Pin Mount Air Valve Knob with Glossy Cross
- Available with 2 Different Scripts in 5 Different Colors, Screw On

Item #	Script	Sticker Color	Package	Pack
<b>23681</b>	Tractor	Black	Carded	1 Pc./Card
<b>23682</b>	Tractor	Blue	Carded	1 Pc./Card
<b>23683</b>	Tractor	Green	Carded	1 Pc./Card
<b>23684</b>	Tractor	Purple	Carded	1 Pc./Card
<b>23685</b>	Tractor	Red	Carded	1 Pc./Card
<b>23687</b>	Trailer	Black	Carded	1 Pc./Card
<b>23688</b>	Trailer	Blue	Carded	1 Pc./Card
<b>23689</b>	Trailer	Green	Carded	1 Pc./Card
<b>23690</b>	Trailer	Purple	Carded	1 Pc./Card
<b>23691</b>	Trailer	Red	Carded	1 Pc./Card



### Chrome Short Air Valve Knob - Pin Mount/Glossy

DESCRIPTION

- Large Chrome Short Air Valve Knob with Glossy Sticker, Pin Mount
- Long Knob Size: 3/8" I.D. x 1 3/8" Tall

Item #	Script	Sticker Color	Package	Pack
<b>23288</b>	Tractor	Black	Carded	1 Pc./Card
<b>23289</b>	Tractor	Blue	Carded	1 Pc./Card
<b>23290</b>	Tractor	Green	Carded	1 Pc./Card
<b>23291</b>	Tractor	Purple	Carded	1 Pc./Card
<b>23292</b>	Tractor	Red	Carded	1 Pc./Card
<b>23293</b>	Tractor	Silver	Carded	1 Pc./Card
<b>23296</b>	Trailer	Black	Carded	1 Pc./Card
<b>23297</b>	Trailer	Blue	Carded	1 Pc./Card
<b>23298</b>	Trailer	Green	Carded	1 Pc./Card
<b>23299</b>	Trailer	Purple	Carded	1 Pc./Card
<b>23300</b>	Trailer	Red	Carded	1 Pc./Card
<b>23301</b>	Trailer	Silver	Carded	1 Pc./Card
<b>23304</b>	Emergency	Black	Carded	1 Pc./Card
<b>23305</b>	Emergency	Blue	Carded	1 Pc./Card
<b>23306</b>	Emergency	Green	Carded	1 Pc./Card
<b>23307</b>	Emergency	Purple	Carded	1 Pc./Card
<b>23308</b>	Emergency	Red	Carded	1 Pc./Card
<b>23309</b>	Emergency	Silver	Carded	1 Pc./Card



**Chrome Short Air Valve Knob - Pin Mount/Aluminum**

## DESCRIPTION

- Large Chrome Short Air Valve Knob with Aluminum Sticker, Pin Mount
- Long Knob Size: 3/8" I.D. x 1 3/8" Tall

Item #	Script	Sticker Color	Package	Pack
23264	Tractor	Black	Carded	1 Pc./Card
23265	Tractor	Blue	Carded	1 Pc./Card
23266	Tractor	Green	Carded	1 Pc./Card
23267	Tractor	Purple	Carded	1 Pc./Card
23268	Tractor	Red	Carded	1 Pc./Card
23269	Tractor	Silver	Carded	1 Pc./Card
23272	Trailer	Black	Carded	1 Pc./Card
23273	Trailer	Blue	Carded	1 Pc./Card
23274	Trailer	Green	Carded	1 Pc./Card
23275	Trailer	Purple	Carded	1 Pc./Card
23276	Trailer	Red	Carded	1 Pc./Card
23277	Trailer	Silver	Carded	1 Pc./Card
23280	Emergency	Black	Carded	1 Pc./Card
23281	Emergency	Blue	Carded	1 Pc./Card
23282	Emergency	Green	Carded	1 Pc./Card
23283	Emergency	Purple	Carded	1 Pc./Card
23284	Emergency	Red	Carded	1 Pc./Card
23285	Emergency	Silver	Carded	1 Pc./Card

**Chrome Short Air Valve Knob - Pin Mount/Stainless**

## DESCRIPTION

- Large Chrome Short Air Valve Knob with Stainless Steel Plaque, Pin Mount
- Short Knob Size: 3/8" I.D. x 1 3/8" Tall

Item #	Script	Script Style	Package	Pack
23181	Tractor	Cursive	Carded	1 Pc./Card
23182	Trailer	Cursive	Carded	1 Pc./Card

**Wood Air Valve Knob**

## DESCRIPTION

- Large Wood Air Valve Knob, Screw-On
- Knob Only

Item #	Description	Package	Pack
23358-1P	Wood Air Valve Knob	Carded	1 Pc./Card
23358-1	Wood Air Valve Knob	Bulk	1 Pc.

**Wood Air Valve Knob - Stainless Steel Plaque**

## DESCRIPTION

- Large Wood Air Valve Knob with Stainless Steel Plaque, Screw-On
- Available with 2 Different Scripts

Item #	Description	Package	Pack
23358	Tractor Knob	Carded	1 Pc./Card
23359	Trailer Knob	Carded	1 Pc./Card

**Stainless Steel Plaque for Wood Air Valve Knob**

## DESCRIPTION

- Stainless Steel Plaque for Wood Air Valve Knob
- Fits Only United Pacific Wood Air Valve Knob

Item #	Description	Package	Pack
23358-2	Tractor	Bulk	1 Pc.
23358-3	Trailer	Bulk	1 Pc.



### Glossy Cross Sticker

DESCRIPTION

- Glossy Cross Sticker for Air Valve Knobs, Sticker Only
- Available with 2 Different Scripts in 6 Different Colors

Item #	Script	Sticker Color	Package	Pack
<b>23222-2K</b>	Tractor	Black	Bulk	1 Pc.
<b>23222-2B</b>	Tractor	Blue	Bulk	1 Pc.
<b>23222-2G</b>	Tractor	Green	Bulk	1 Pc.
<b>23222-2P</b>	Tractor	Purple	Bulk	1 Pc.
<b>23222-2R</b>	Tractor	Red	Bulk	1 Pc.
<b>23229-2K</b>	Trailer	Black	Bulk	1 Pc.
<b>23229-2B</b>	Trailer	Blue	Bulk	1 Pc.
<b>23229-2G</b>	Trailer	Green	Bulk	1 Pc.
<b>23229-2P</b>	Trailer	Purple	Bulk	1 Pc.
<b>23229-2R</b>	Trailer	Red	Bulk	1 Pc.



23222-2K



23222-2G



23229-2B



23229-2P



23229-2R



VISIT [UPauto.com/truck](http://UPauto.com/truck)  
FOR THE LATEST PRODUCTS

### Glossy Sticker

DESCRIPTION

- Glossy Sticker for Air Valve Knobs, Sticker Only
- Available with 3 Different Scripts in 6 Different Colors

Item #	Script	Sticker Color	Package	Pack
<b>23222-1K</b>	Tractor	Black	Bulk	1 Pc.
<b>23222-1B</b>	Tractor	Blue	Bulk	1 Pc.
<b>23222-1G</b>	Tractor	Green	Bulk	1 Pc.
<b>23222-1P</b>	Tractor	Purple	Bulk	1 Pc.
<b>23222-1R</b>	Tractor	Red	Bulk	1 Pc.
<b>23222-1S</b>	Tractor	Silver	Bulk	1 Pc.
<b>23229-1K</b>	Trailer	Black	Bulk	1 Pc.
<b>23229-1B</b>	Trailer	Blue	Bulk	1 Pc.
<b>23229-1G</b>	Trailer	Green	Bulk	1 Pc.
<b>23229-1P</b>	Trailer	Purple	Bulk	1 Pc.
<b>23229-1R</b>	Trailer	Red	Bulk	1 Pc.
<b>23229-1S</b>	Trailer	Silver	Bulk	1 Pc.
<b>23236-1K</b>	Emergency	Black	Bulk	1 Pc.
<b>23236-1B</b>	Emergency	Blue	Bulk	1 Pc.
<b>23236-1G</b>	Emergency	Green	Bulk	1 Pc.
<b>23236-1P</b>	Emergency	Purple	Bulk	1 Pc.
<b>23236-1R</b>	Emergency	Red	Bulk	1 Pc.



23222-1K



23222-1B



23229-1G



23229-1P



23236-1R



23229-1S

## Aluminum Sticker

### DESCRIPTION

- Aluminum Sticker for Air Valve Knobs, Sticker Only
- Available with 3 Different Scripts in 6 Different Styles

Item #	Script	Sticker Color	Package	Pack
<b>23010-2K</b>	Tractor	Black	Bulk	1 Pc.
<b>23010-2B</b>	Tractor	Blue	Bulk	1 Pc.
<b>23010-2G</b>	Tractor	Green	Bulk	1 Pc.
<b>23010-2P</b>	Tractor	Purple	Bulk	1 Pc.
<b>23010-2R</b>	Tractor	Red	Bulk	1 Pc.
<b>23010-2S</b>	Tractor	Silver	Bulk	1 Pc.
<b>23010-3K</b>	Trailer	Black	Bulk	1 Pc.
<b>23010-3B</b>	Trailer	Blue	Bulk	1 Pc.
<b>23010-3G</b>	Trailer	Green	Bulk	1 Pc.
<b>23010-3P</b>	Trailer	Purple	Bulk	1 Pc.
<b>23010-3R</b>	Trailer	Red	Bulk	1 Pc.
<b>23010-3S</b>	Trailer	Silver	Bulk	1 Pc.
<b>23010-4K</b>	Emergency	Black	Bulk	1 Pc.
<b>23010-4B</b>	Emergency	Blue	Bulk	1 Pc.
<b>23010-4G</b>	Emergency	Green	Bulk	1 Pc.
<b>23010-4P</b>	Emergency	Purple	Bulk	1 Pc.
<b>23010-4R</b>	Emergency	Red	Bulk	1 Pc.
<b>23010-4S</b>	Emergency	Silver	Bulk	1 Pc.



23010-2K



23010-2B



23010-3G



23010-3P



23010-4R



23010-4S

## Stainless Steel Plaque

### DESCRIPTION

- Stainless Steel Plaque for Air Valve Knobs, Plaque Only

Item #	Script	Package	Pack
<b>23364-1</b>	Tractor	Bulk	1 Pc.
<b>23364-2</b>	Trailer	Bulk	1 Pc.



23364-1



23364-2

## Stainless Steel Plaque - Diamond Cut Out

### DESCRIPTION

- Stainless Steel Plaque with Diamond Cut Out

Item #	Script	Material	Package	Pack
<b>23522</b>	Tractor	Stainless	Skin Packed	1 Pc./Pack
<b>23523</b>	Trailer	Stainless	Skin Packed	1 Pc./Pack



23522



23523

## New Item

### Axle Cover Combo Kit - 33mm

#### DESCRIPTION

- Includes Everything You Need To Dress Up Your Wheels
- Chrome Plastic Front Axle Cover x 2
- Chrome Plastic Rear Axle Cover x 2
- Chrome Plastic 33mm Thread-On Nut Cover x 60
- Nut Cover Tool x 1

Item #	Description	Finish	Pack
<b>10305</b>	Axle Cover Combo Kit	Chrome	6 Pc./Pack



# A/C VENT & ACCESSORIES

## Freightliner Chrome A/C Vents

### DESCRIPTION

- Chrome Plastic A/C Vent, Direct Replacement
- Available for Various Models and Years

Item #	Description	Package	Pack
<b>41110</b>	Century Vent	Carded	1 Pc./Card
<b>41023</b>	FLD/Classic Long Vent	Carded	1 Pc./Card
<b>41024</b>	FLD/Classic w/o Cross Grids	Carded	1 Pc./Card
<b>41025</b>	FLD/Classic w/ Cross Grids	Carded	1 Pc./Card
<b>41111</b>	Center Top A/C Vent	Carded	1 Pc./Card
<b>41950</b>	Sleeper Vent	Carded	1 Pc./Card

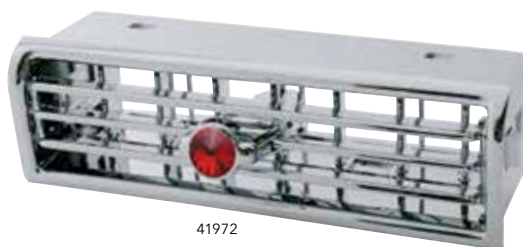
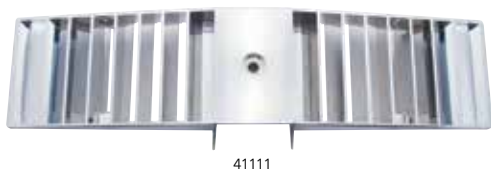

## Freightliner Cascadia Chrome A/C Vents

### DESCRIPTION

- Chrome Plastic A/C Vent, Direct Replacement
- Available for Freightliner Cascadia

Item #	Description	Package	Pack
<b>42091</b>	Cascadia A/C Vent - Driver	Carded	1 Pc./Card
<b>42092</b>	Cascadia Vent - Passenger	Carded	1 Pc./Card
<b>42067</b>	Cascadia A/C Vent	Carded	1 Pc./Card



## Freightliner A/C Vent - Diamond

### DESCRIPTION

- Chrome A/C Vent for Freightliner Century, Coronado & Columbia
- Available with or without Diamond

Item #	Script	Jewel Color	Package	Pack
<b>41968</b>	Diamond	Blue	Carded	1 Pc./Card
<b>41971</b>	Diamond	Purple	Carded	1 Pc./Card
<b>41972</b>	Diamond	Red	Carded	1 Pc./Card
<b>41966</b>	Indented	-	Carded	1 Pc./Card

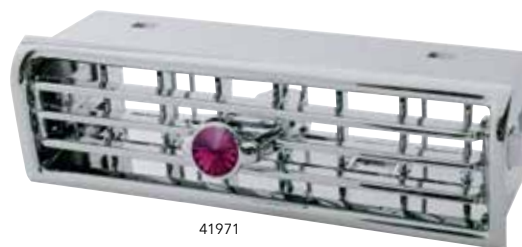

**2007+ Freightliner Cascadia A/C Control Cover**

## DESCRIPTION

- Chrome Plastic A/C Control Cover for 2007+ Freightliner Cascadia
- Double-Sided Tape Mount, Fits Over OEM Control Unit

Item #	Description	Package	Pack
<b>42337</b>	Cascadia A/C Control Cover	Carded	1 Pc./Card

**For Newer Freightliner****Freightliner A/C Knob - Newer Model**

## DESCRIPTION

- Chrome Plastic A/C Knob for Newer Freightliner Century, Coronado and Columbia

Item #	Description	Package	Pack
<b>42020</b>	FL A/C Knob - Newer Model	Carded	1 Pc./Card

**Signature Freightliner A/C Knob - Diamond**

## DESCRIPTION

- Signature A/C Knob for Newer FL Century, Coronado & Columbia
- Available with or without Crystal Diamonds

Item #	Style	Jewel Color	Package	Pack
<b>42022</b>	Diamond	Amber	Carded	1 Pc./Card
<b>42023</b>	Diamond	Blue	Carded	1 Pc./Card
<b>42024</b>	Diamond	Clear	Carded	1 Pc./Card
<b>42025</b>	Diamond	Green	Carded	1 Pc./Card
<b>42026</b>	Diamond	Purple	Carded	1 Pc./Card
<b>42027</b>	Diamond	Red	Carded	1 Pc./Card
<b>42021</b>	Indented	-	Carded	1 Pc./Card

**2007+ Freightliner Cascadia A/C Knob Cover**

## DESCRIPTION

- Chrome Plastic A/C Knob Cover for 2007+ Freightliner Cascadia
- Sold in Sets, Set = 6 Pieces

Item #	Description	Package	Pack
<b>42064</b>	Cascadia A/C Knob Cover	Carded	1 Set/Card

**For Older Freightliner****Freightliner A/C Knob - Older Model**

## DESCRIPTION

- Chrome Plastic A/C Knob for Older Freightliner Century, Coronado and Columbia

Item #	Description	Package	Pack
<b>41091</b>	FL A/C Knob - Older Model	Carded	1 Pc./Card

**Signature Freightliner A/C Knob - Diamond**

## DESCRIPTION

- Signature A/C Knob for Older FL Century, Coronado & Columbia
- Available with or without Crystal Diamonds

Item #	Style	Jewel Color	Package	Pack
<b>41171</b>	Diamond	Amber	Carded	1 Pc./Card
<b>41172</b>	Diamond	Blue	Carded	1 Pc./Card
<b>41173</b>	Diamond	Clear	Carded	1 Pc./Card
<b>41174</b>	Diamond	Green	Carded	1 Pc./Card
<b>41175</b>	Diamond	Purple	Carded	1 Pc./Card
<b>41176</b>	Diamond	Red	Carded	1 Pc./Card
<b>41170</b>	Indented	-	Carded	1 Pc./Card



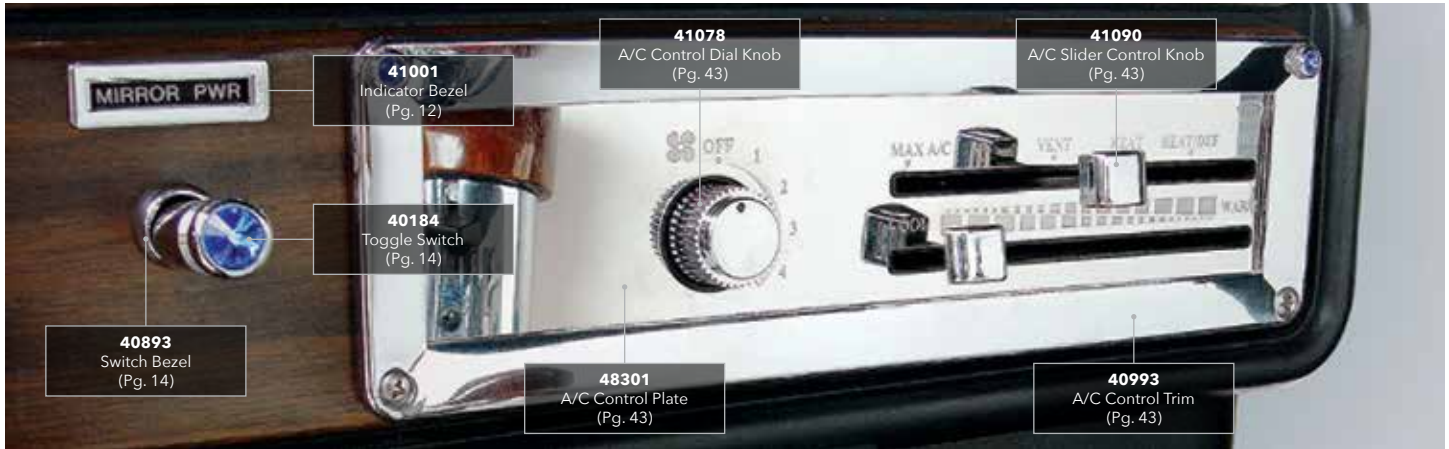

### Freightliner A/C Control Trim

#### DESCRIPTION

- Chrome Plastic A/C Control Trim for Freightliner Classic and FLD

Item #	Description	Package	Pack
<b>40993</b>	A/C Control Trim	Carded	1 Pc./Card



### Freightliner A/C Control Dial Knob - Diamond

#### DESCRIPTION

- Chrome Plated Plastic Knob with Glass Diamond Jewel
- Fits Most Models of Freightliner A/C Controls
- Universal Application, Fits Most 1/4" D-Flat Shafts
- Attaches Securely with Hex Set Screw

Item #	Style	Jewel Color	Package	Pack
<b>41152</b>	Diamond	Blue	Carded	1 Pc./Card
<b>41153</b>	Diamond	Clear	Carded	1 Pc./Card
<b>41155</b>	Diamond	Purple	Carded	1 Pc./Card
<b>41156</b>	Diamond	Red	Carded	1 Pc./Card
<b>41078</b>	Plain	-	Carded	1 Pc./Card



### Freightliner Stainless A/C Control Plate

#### DESCRIPTION

- Stainless Steel 10 1/4" x 2 3/16" Freightliner A/C Control Plate
- Fits Freightliner Classic & FLD
- Available with or without Recirculate Opening

Item #	Description	Package	Pack
<b>48301</b>	Without Recirculate Opening	Carded	1 Pc./Card
<b>48302</b>	Recirculate Opening	Carded	1 Pc./Card



48301



48302

### Freightliner A/C Slider Control Knob - Diamond

#### DESCRIPTION

- Chrome Plastic Signature Freightliner A/C Knob for Older FL Century, Coronado & Columbia
- Available with or without Crystal Diamonds

Item #	Style	Jewel Color	Package	Pack
<b>42030</b>	Diamond	Amber	Carded	3 Pcs./Card
<b>42031</b>	Diamond	Blue	Carded	3 Pcs./Card
<b>42032</b>	Diamond	Clear	Carded	3 Pcs./Card
<b>42033</b>	Diamond	Green	Carded	3 Pcs./Card
<b>42034</b>	Diamond	Purple	Carded	3 Pcs./Card
<b>42035</b>	Diamond	Red	Carded	3 Pcs./Card
<b>41090</b>	Plain	-	Carded	3 Pcs./Card



# GLOVE BOX ACCESSORIES

## Freightliner Century Emblem Bezel

### DESCRIPTION

- Chrome Plastic Century Emblem Bezel for Freightliner
- Fits Various Years, Available Carded Only

Item #	Description	Package	Pack
<b>20596</b>	Emblem Bezel	Carded	1 Pc./Card



## Freightliner Stainless Upper Dash Cover - Passenger

### DESCRIPTION

- Stainless Steel Upper Passenger Dash Cover for FL Century, Coronado, and Columbia
- Folds Over the Entire Upper Dash Panel

Item #	Description	Package	Pack
<b>21053</b>	Upper Dash Cover	Skin Packed	1 Pc./Pack



## Freightliner Wood Ashtray Trim

### DESCRIPTION

- Wood Ashtray Trim for Freightliner
- Fits Freightliner Classic and FLD

Item #	Description	Package	Pack
<b>88082</b>	Wood Ashtray Trim	Boxed	1 Pc./Box

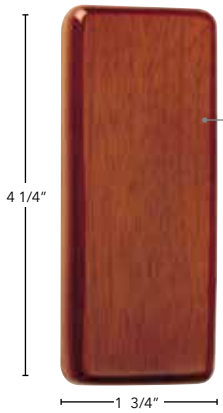

## Freightliner Stainless Glove Box Cover

### DESCRIPTION

- Stainless Steel Glove Box Cover for Freightliner Classic and FLD
- Folded Corners Cover the Entire Glove Box

Item #	Description	Package	Pack
<b>21054</b>	Glove Box Cover	Skin Packed	1 Pc./Pack



## Freightliner Ashtray

### DESCRIPTION

- Chrome Plastic Ashtray for Freightliner Classic and FLD

Item #	Description	Package	Pack
<b>41077</b>	Ashtray	Carded	1 Pc./Card

## Freightliner Stainless Knee Pad Cover

### DESCRIPTION

- Stainless Steel Knee Pad Cover for Freightliner Classic and FLD
- Folded Corners Cover the Entire Knee Pad

Item #	Description	Package	Pack
<b>21055</b>	Knee Pad Cover	Skin Packed	1 Pc./Pack



# DIAMOND ACCESSORIES

## Chrome Bolt Heads - Diamond

### DESCRIPTION

- Chrome Bolt Heads with Crystal Diamond, Universal Application
- Create the Look of the Vintage Truck Dash with These Imitation Dash Screws
- Double Sided Tape Mount, Limitless Mounting Possibilities

Item #	Style	Jewel Color	Package	Pack
<b>23907</b>	Diamond	Amber	Carded	4 Pcs./Card
<b>23908</b>	Diamond	Blue	Carded	4 Pcs./Card
<b>23909</b>	Diamond	Clear	Carded	4 Pcs./Card
<b>23910</b>	Diamond	Green	Carded	4 Pcs./Card
<b>23911</b>	Diamond	Purple	Carded	4 Pcs./Card
<b>23912</b>	Diamond	Red	Carded	4 Pcs./Card
<b>23906</b>	Indented	-	Carded	4 Pcs./Card
<b>23905</b>	Plain	-	Carded	4 Pcs./Card



## Hot Item

### 7 LED Freightliner Turn Signal Light

#### DESCRIPTION

- 7 LED Turn Signal Light for Freightliner
- Available in Amber or Clear Lens
- Fits Freightliner Cascadia and Various Freightliner Models
- OEM Plug
- OEM Part Number: A06-58770-000

Item #	LEDs	Lens	Package	Pack
<b>37077</b>	7 Amber	Amber	Carded	1 Pc./Card
<b>37078</b>	7 Amber	Clear	Carded	1 Pc./Card



### 15 LED Clearance/Marker Light

#### DESCRIPTION

- 15 LED Freightliner Teardrop Sleeper Clearance/Marker Light
- Available in Amber or Clear Lens
- 3 Wires (1 Wire with Ring Terminal)
- Please Note: This Light Only Meets DOT/SAE P2 Requirements
- For Clearance/Marker Use Only

Item #	LEDs	Lens	Package	Pack
<b>38448</b>	15 Amber	Amber	Carded	1 Pc./Card
<b>38449</b>	15 Amber	Clear	Carded	1 Pc./Card



# LOWER CENTER DASH COLUMN



Center Console Panel  
Pg. 47



Cup Holder Panel  
Pg. 48



Storage Panel  
Pg. 48



Cigarette Holder  
Pg. 53



Lighter  
Pg. 50



Ashtray  
Pg. 49



Lighter Plate  
Pg. 50



Cup Holder  
Pg. 50

# LOWER CENTER DASH PANELS



## Freightliner Center Console Panel

### DESCRIPTION

- Chrome Plastic Center Console Panel
- Fits Newer Freightliner Century, Coronado & Columbia

Item #	Description	Package	Pack
<b>41907</b>	Center Console	Carded	1 Pc./Card

## Freightliner Century Ashtray Insert

### DESCRIPTION

- Chrome Plastic Ashtray for Freightliner Century

Item #	Description	Package	Pack
<b>41902</b>	Ashtray Insert	Carded	1 Pc./Card



## Freightliner Century Ashtray Panel

### DESCRIPTION

- Chrome Plastic Center Console Ashtray Panel
- Fits Freightliner Century and Columbia

Item #	Description	Package	Pack
<b>41901</b>	Ashtray Panel	Carded	1 Pc./Card





41901



41903



41904

**Freightliner Century Cup Holder Panel**

**DESCRIPTION**

- Chrome Plastic Center Console Cup Holder Panel
- Fits Freightliner Century and Columbia

Item #	Description	Package	Pack
<b>41903</b>	Cup Holder Panel	Carded	1 Pc./Card



**Freightliner Century Ashtray Panel**

**DESCRIPTION**

- Chrome Plastic Center Console Ashtray Panel
- Fits Freightliner Century and Columbia
- Available with or without groove, Grooves designed for panel stickers

Item #	Description	Package	Pack
<b>41904</b>	Panel with Groove	Carded	1 Pc./Card
<b>41905</b>	Panel without Groove	Carded	1 Pc./Card



41904



41905

### Freightliner Lower Center Console Trim

DESCRIPTION

- Stainless Steel Lower Center Console Trim
- Fits Newer Freightliner Century, Columbia, and Coronado

Item #	Description	Package	Pack
<b>21728</b>	Lower Console Trim	Carded	1 Pc./Card

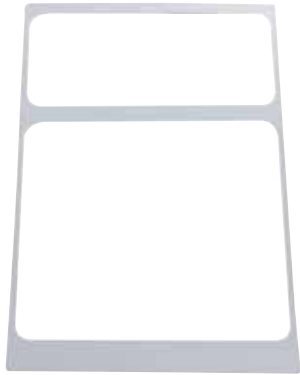

### Freightliner Stainless Storage Bin Cover

DESCRIPTION

- Stainless Steel Lower Center Storage Bin Cover
- Fits Newer Freightliner Century, Columbia, and Coronado

Item #	Description	Package	Pack
<b>41940</b>	Storage Bin Cover	Skin Packed	1 Pc./Pack



### Freightliner Stainless Ashtray Cover

DESCRIPTION

- Stainless Steel Freightliner Ashtray Cover
- Available Carded or Bulk, Fits Various Models and Years

Item #	Description	Package	Pack
<b>23000</b>	Stainless Ashtray Cover	Carded	1 Pc./Card

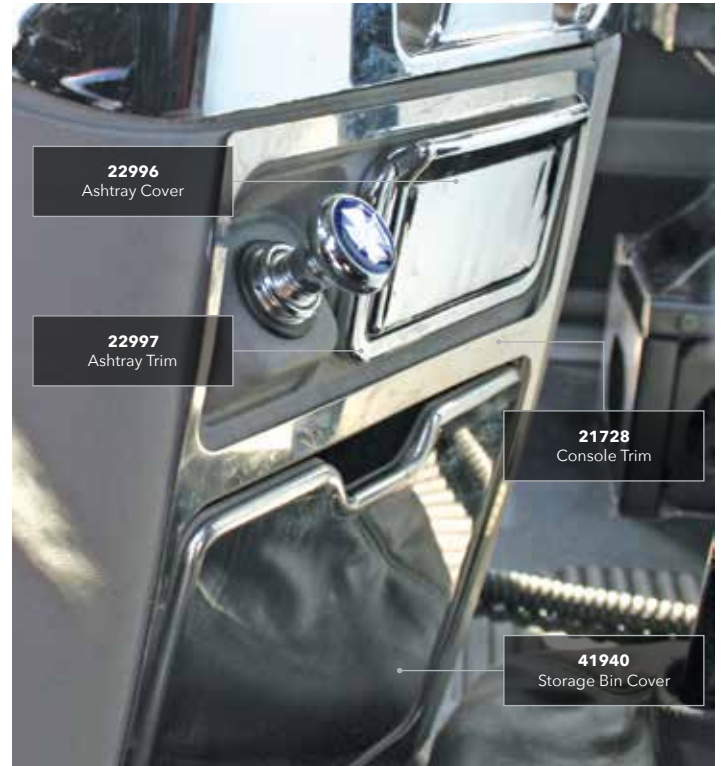

### Freightliner Ashtray

DESCRIPTION

- Chrome Plastic Freightliner Ashtray, Available for Various Years
- Ashtray & Ashtray Trim Sold Separately

Item #	Description	Package	Pack
<b>22996</b>	Ashtray	Carded	1 Pc./Card
<b>22997</b>	Ashtray Trim	Carded	1 Pc./Card

**Freightliner Cup Holder**

## DESCRIPTION

- Chrome Plastic Cup Holder for Freightliner
- Fits Freightliner Classic and FLD

Item #	Description	Package	Pack
<b>40990</b>	Driver Side	Carded	1 Pc./Card
<b>40991</b>	Passenger Side	Carded	1 Pc./Card

**Freightliner Lighter Plate**

## DESCRIPTION

- Stainless Steel Freightliner Lighter Plate Replacement
- Laser Etched, Available in 3 Different Styles

Item #	Description	Package	Pack
<b>48119</b>	Lighter Only	Carded	1 Pc./Card
<b>48127</b>	Lighter/Window (R)	Carded	1 Pc./Card
<b>48128</b>	Lighter/Window (L & R)	Carded	1 Pc./Card



48119



48127



48128

**Chrome Gun Barrel Cigarette Lighter**

## DESCRIPTION

- Chrome Aluminum Gun Barrel Cigarette Lighter
- Fits Most Lighter Sockets

Item #	Description	Package	Pack
<b>23059</b>	Gun Barrel Lighter	Carded	1 Pc./Card

**Chrome Deluxe Cigarette Lighter - Indented**

## DESCRIPTION

- Deluxe Cigarette Lighter with Diamond Indent
- Fits Most Lighter Sockets

Item #	Description	Package	Pack
<b>28478</b>	Deluxe Lighter w/ Indent	Carded	1 Pc./Card

**Chrome Deluxe Cigarette Lighter - Diamond**

## DESCRIPTION

- Deluxe Cigarette Lighter with Diamond
- Fits Most Lighter Sockets
- Available with 6 Different Color Diamonds

Item #	Style	Jewel Color	Package	Pack
<b>28479</b>	Diamond	Amber	Carded	1 Pc./Card
<b>28480</b>	Diamond	Blue	Carded	1 Pc./Card
<b>28481</b>	Diamond	Clear	Carded	1 Pc./Card
<b>28482</b>	Diamond	Green	Carded	1 Pc./Card
<b>28483</b>	Diamond	Purple	Carded	1 Pc./Card
<b>28484</b>	Diamond	Red	Carded	1 Pc./Card



28479



28480



28481



28482



28483



28484

### Chrome Deluxe Cigarette Lighter

DESCRIPTION

- Deluxe Chrome Aluminum Cigarette Lighter
- Fits Most Lighter Sockets

Item #	Description	Package	Pack
<b>28485</b>	Deluxe Lighter	Carded	1 Pc./Card



### Chrome Deluxe Cigarette Lighter - Glossy Cross Sticker

DESCRIPTION

- Deluxe Chrome Aluminum Lighter with Glossy Cross Sticker
- Fits Most Lighter Sockets
- Available with 6 Different Color Glossy Stickers

Item #	Sticker	Sticker Color	Package	Pack
<b>28471</b>	Cross	Black	Carded	1 Pc./Card
<b>28472</b>	Cross	Blue	Carded	1 Pc./Card
<b>28473</b>	Cross	Green	Carded	1 Pc./Card
<b>28474</b>	Cross	Purple	Carded	1 Pc./Card
<b>28475</b>	Cross	Red	Carded	1 Pc./Card
<b>28476</b>	Cross	Silver	Carded	1 Pc./Card



### Chrome Deluxe Cigarette Lighter - Glossy Sticker

DESCRIPTION

- Deluxe Chrome Aluminum Cigarette Lighter with Glossy Sticker
- Fits Most Lighter Sockets
- Available with 4 Different Color Glossy Stickers

Item #	Sticker	Sticker Color	Package	Pack
<b>28487</b>	Glossy	Blue	Carded	1 Pc./Card
<b>28489</b>	Glossy	Purple	Carded	1 Pc./Card
<b>28490</b>	Glossy	Red	Carded	1 Pc./Card
<b>28491</b>	Glossy	Silver	Carded	1 Pc./Card



### Chrome Deluxe Cigarette Lighter - Aluminum Sticker

DESCRIPTION

- Deluxe Chrome Aluminum Cigarette Lighter with Aluminum Sticker
- Fits Most Lighter Sockets
- Available with 5 Different Color Aluminum Stickers

Item #	Sticker	Sticker Color	Package	Pack
<b>28492</b>	Aluminum	Black	Carded	1 Pc./Card
<b>28493</b>	Aluminum	Blue	Carded	1 Pc./Card
<b>28495</b>	Aluminum	Purple	Carded	1 Pc./Card
<b>28496</b>	Aluminum	Red	Carded	1 Pc./Card
<b>28497</b>	Aluminum	Silver	Carded	1 Pc./Card



**Chrome Deluxe Cigarette Lighter - Stainless Plaque**

## DESCRIPTION

- Deluxe Cigarette Lighter with Stainless Steel Plaque
- Laser Etched Stainless Steel Plaque Available Separately

Item #	Script	Plaque	Package	Pack
<b>28498</b>	Lighter	Stainless	Carded	1 Pc./Card

**Chrome Cigarette Lighter Knob**

## DESCRIPTION

- Chrome Aluminum Cigarette Lighter Knob
- Knob Only

Item #	Description	Package	Pack
<b>23060-1P</b>	Lighter Knob Only	Carded	1 Pc./Card

**Chrome Cigarette Lighter Knob - Glossy Cross Sticker**

## DESCRIPTION

- Chrome Aluminum Cigarette Lighter Knob with Glossy Cross Sticker
- Available with 6 Different Color Glossy Stickers

Item #	Sticker	Sticker Color	Package	Pack
<b>23500</b>	Cross	Black	Carded	1 Pc./Card
<b>23501</b>	Cross	Blue	Carded	1 Pc./Card
<b>23502</b>	Cross	Green	Carded	1 Pc./Card
<b>23503</b>	Cross	Purple	Carded	1 Pc./Card
<b>23504</b>	Cross	Red	Carded	1 Pc./Card
<b>23505</b>	Cross	Silver	Carded	1 Pc./Card

**Chrome Cigarette Lighter Knob - Glossy Sticker**

## DESCRIPTION

- Chrome Aluminum Cigarette Lighter Knob with Glossy Sticker
- Available with 4 Different Color Glossy Stickers

Item #	Sticker	Sticker Color	Package	Pack
<b>23161</b>	Glossy	Blue	Carded	1 Pc./Card
<b>23163</b>	Glossy	Purple	Carded	1 Pc./Card
<b>23164</b>	Glossy	Red	Carded	1 Pc./Card
<b>23165</b>	Glossy	Silver	Carded	1 Pc./Card

**Chrome Cigarette Lighter Knob - Aluminum Sticker**

## DESCRIPTION

- Chrome Aluminum Cigarette Lighter Knob with Aluminum Sticker
- Available with 5 Different Color Aluminum Stickers

Item #	Sticker	Sticker Color	Package	Pack
<b>23060</b>	Aluminum	Black	Carded	1 Pc./Card
<b>23061</b>	Aluminum	Blue	Carded	1 Pc./Card
<b>23062</b>	Aluminum	Green	Carded	1 Pc./Card
<b>23063</b>	Aluminum	Purple	Carded	1 Pc./Card
<b>23064</b>	Aluminum	Red	Carded	1 Pc./Card
<b>23065</b>	Aluminum	Silver	Carded	1 Pc./Card





**Glossy Cross Lighter Sticker Only**

DESCRIPTION

- Glossy Cross Sticker for Cigarette Lighter Knob, Sticker Only
- Available with 6 Different Colors

Item #	Sticker	Sticker Color	Package	Pack
<b>23160-2K</b>	Cross	Black	Bulk	1 Pc.
<b>23160-2B</b>	Cross	Blue	Bulk	1 Pc.
<b>23160-2G</b>	Cross	Green	Bulk	1 Pc.
<b>23160-2P</b>	Cross	Purple	Bulk	1 Pc.
<b>23160-2R</b>	Cross	Red	Bulk	1 Pc.
<b>23160-2S</b>	Cross	Silver	Bulk	1 Pc.



23160-2K



23160-2B



23160-2G



23160-2P



23160-2R



23160-2S

**Glossy Lighter Sticker Only**

DESCRIPTION

- Glossy Sticker for Cigarette Lighter Knob, Sticker Only
- Available with 4 Different Colors

Item #	Sticker	Sticker Color	Package	Pack
<b>23160-1B</b>	Glossy	Blue	Bulk	1 Pc.
<b>23160-1P</b>	Glossy	Purple	Bulk	1 Pc.
<b>23160-1R</b>	Glossy	Red	Bulk	1 Pc.
<b>23160-1S</b>	Glossy	Silver	Bulk	1 Pc.



23160-1B



23160-1P



23160-1R



23160-1S

**Aluminum Lighter Sticker Only**

DESCRIPTION

- Aluminum Sticker for Cigarette Lighter Knob, Sticker Only
- Available in 6 Different Colors

Item #	Sticker	Sticker Color	Package	Pack
<b>23060-2K</b>	Aluminum	Black	Carded	1 Pc./Card
<b>23060-2B</b>	Aluminum	Blue	Carded	1 Pc./Card
<b>23060-2G</b>	Aluminum	Green	Carded	1 Pc./Card
<b>23060-2P</b>	Aluminum	Purple	Carded	1 Pc./Card
<b>23060-2R</b>	Aluminum	Red	Carded	1 Pc./Card
<b>23060-2S</b>	Aluminum	Silver	Carded	1 Pc./Card



23060-2K



23060-2B



23060-2G



23060-2P



23060-2R



23060-2S

**Stainless Steel Lighter Plaque Only**

DESCRIPTION

- Stainless Steel Lighter Plaque for Cigarette Lighter Knob
- Laser Etched for Unparalleled Detail

Item #	Script	Plaque	Package	Pack
<b>23378-8</b>	Lighter	Stainless	Carded	1 Pc./Card



**Stainless Steel Storage Compartment**

DESCRIPTION

- Stainless Steel Storage Compartments Designed for Tobacco Cans or Cigarette Packs
- Available with Double Sided Tape on Back, Universal Application

Item #	Description	Package	Pack
<b>21802</b>	Cigarette Pack Holder	Carded	1 Pc./Card





# STEERING WHEEL/COLUMN ACCESSORIES



Upper Steering Column Cover  
Pg. 63



Turn Signal Lever  
Pg. 64



Turn Signal Lever  
Pg. 65



Wood Steering Wheel  
Pg. 59



Lower Steering Column Cover  
Pg. 63



Turn Signal Switch Cover  
Pg. 65



Steering Wheel Spinner  
Pg. 62



Steering Wheel Cover  
Pg. 60

**18" Steering Wheel - Wood**

DESCRIPTION

- 18" Wood Steering Wheel with Chrome Spokes
- Steering Wheel Only, Hub and Horn Assembly Available Separately
- Mix and Match with United Pacific's Hub and Designer Horn Bezel for an Unique and Distinctive Look

Item #	Style	Finish	Package	Pack
<b>88217</b>	4 Spoke	Wood	Boxed	1 Pc./Box
<b>88218</b>	"Boss"	Wood	Boxed	1 Pc./Box
<b>88219</b>	"Lady"	Wood	Boxed	1 Pc./Box
<b>88220</b>	"Flame"	Wood	Boxed	1 Pc./Box
<b>88221</b>	"GT"	Wood	Boxed	1 Pc./Box
<b>88222</b>	"Blade"	Wood	Boxed	1 Pc./Box
<b>88214</b>	"3 Spoke"	Wood	Boxed	1 Pc./Box
<b>88239</b>	"Wing"	Wood	Boxed	1 Pc./Box



**18" Steering Wheel - Electric Blue**

DESCRIPTION

- 18" Wood Steering Wheel with Chrome Spokes
- Steering Wheel Only, Hub and Horn Assembly Available Separately
- Mix and Match with United Pacific's Hub and Designer Horn Bezel for an Unique and Distinctive Look

Item #	Style	Finish	Package	Pack
<b>88224</b>	4 Spoke	Electric Blue	Boxed	1 Pc./Box
<b>88226</b>	"Boss"	Electric Blue	Boxed	1 Pc./Box
<b>88240</b>	"Lady"	Electric Blue	Boxed	1 Pc./Box
<b>88242</b>	"Flame"	Electric Blue	Boxed	1 Pc./Box
<b>88244</b>	"GT"	Electric Blue	Boxed	1 Pc./Box
<b>88246</b>	"Blade"	Electric Blue	Boxed	1 Pc./Box

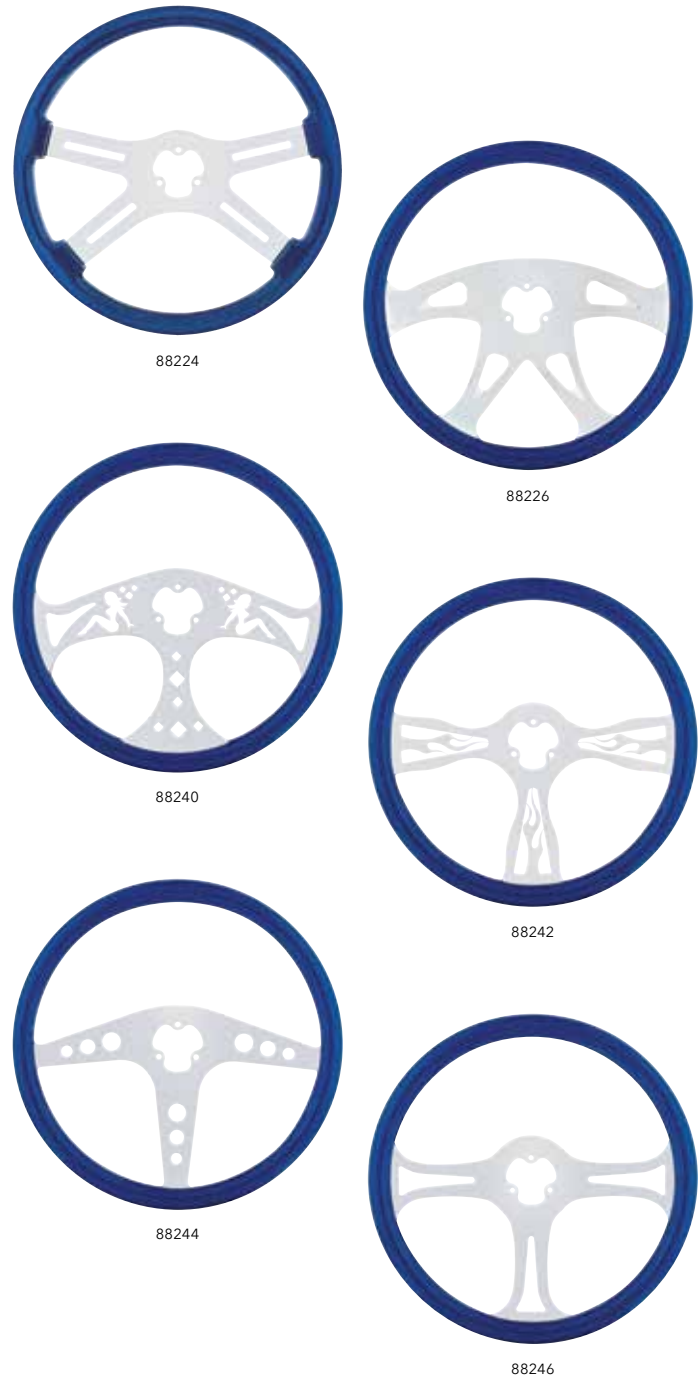

**18" Steering Wheel - Indigo Red**

DESCRIPTION

- 18" Wood Steering Wheel with Chrome Spokes
- Steering Wheel Only, Hub and Horn Assembly Available Separately
- Mix and Match with United Pacific's Hub and Designer Horn Bezel for a Unique and Distinctive Look

Item #	Style	Finish	Package	Pack
<b>88225</b>	4 Spoke	Wood	Boxed	1 Pc./Box
<b>88229</b>	"Boss"	Wood	Boxed	1 Pc./Box
<b>88241</b>	"Lady"	Wood	Boxed	1 Pc./Box
<b>88243</b>	"Flame"	Wood	Boxed	1 Pc./Box
<b>88245</b>	"GT"	Wood	Boxed	1 Pc./Box
<b>88247</b>	"Blade"	Wood	Boxed	1 Pc./Box



88225



88229



88241



88243



88245



88247

**18" Steering Wheel - Stainless Steel**

DESCRIPTION

- 18" Stainless Steel Steering Wheel
- Highly Polished Stainless Steel Finish, Wheel Only
- Hub and Horn Assembly Sold Separately, Fits United Pacific Hub/Horn Assembly Only

Item #	Style	Finish	Package	Pack
<b>88210</b>	4 Spoke	Stainless	Boxed	1 Pc./Box
<b>88215</b>	"Boss"	Stainless	Boxed	1 Pc./Box



88210



88215

**18" Steering Wheel - Carbon Black**

DESCRIPTION

- 18" Diameter with a Deep Luxurious Carbon-Black Woodgrain Finish
- Steering Wheel Only, Hub and Horn Assembly Available Separately
- Mix and Match with United Pacific Hub and Designer Horn Bezel for a Unique and Distinctive Look

Item #	Style	Finish	Package	Pack
<b>88237</b>	4 Spoke	Carbon Black	Boxed	1 Pc./Box
<b>88257</b>	3 Spoke	Carbon Black	Boxed	1 Pc./Box
<b>88258</b>	2 Spoke	Carbon Black	Boxed	1 Pc./Box



88237



88257



88258

**18" Steering Wheel - Flame**

## DESCRIPTION

- 18" Wood Steering Wheel with Chrome Spoke and Hydro-Dip Flame Finish
- Steering Wheel Only, Hub and Horn Assembly Available Separately

Item #	Style	Pattern	Package	Pack
<b>88248</b>	Boss	Flame	Boxed	1 Pc./Box
<b>88249</b>	Boss	Flame	Boxed	1 Pc./Box
<b>88250</b>	Lady	Flame	Boxed	1 Pc./Box

**18" Steering Wheel - Skull**

## DESCRIPTION

- 18" Wood Steering Wheel with Chrome Spokes and Hydro-Dip Skull Finish
- Steering Wheel Only, Hub and Horn Assembly Available Separately

Item #	Style	Color	Package	Pack
<b>88234</b>	Skull	White	Boxed	1 Pc./Box
<b>88235</b>	Skull	Blue	Boxed	1 Pc./Box
<b>88236</b>	Skull	Red	Boxed	1 Pc./Box

**18" Steering Wheel - Freightliner 1989-July 2006**

## DESCRIPTION

- 18" Chrome Steering Wheel
- Fits Freightliner 1989-July 2006 Fixed and Adjustable Steering Columns

Item #	Style	Application	Package	Pack
<b>88130</b>	4 Spoke	1989-07/2006	Boxed	1 Pc./Box
<b>88131</b>	Lady	1989-07/2006	Boxed	1 Pc./Box
<b>88132</b>	Boss	1989-07/2006	Boxed	1 Pc./Box
<b>88133</b>	Flame	1989-07/2006	Boxed	1 Pc./Box
<b>88134</b>	GT	1989-07/2006	Boxed	1 Pc./Box

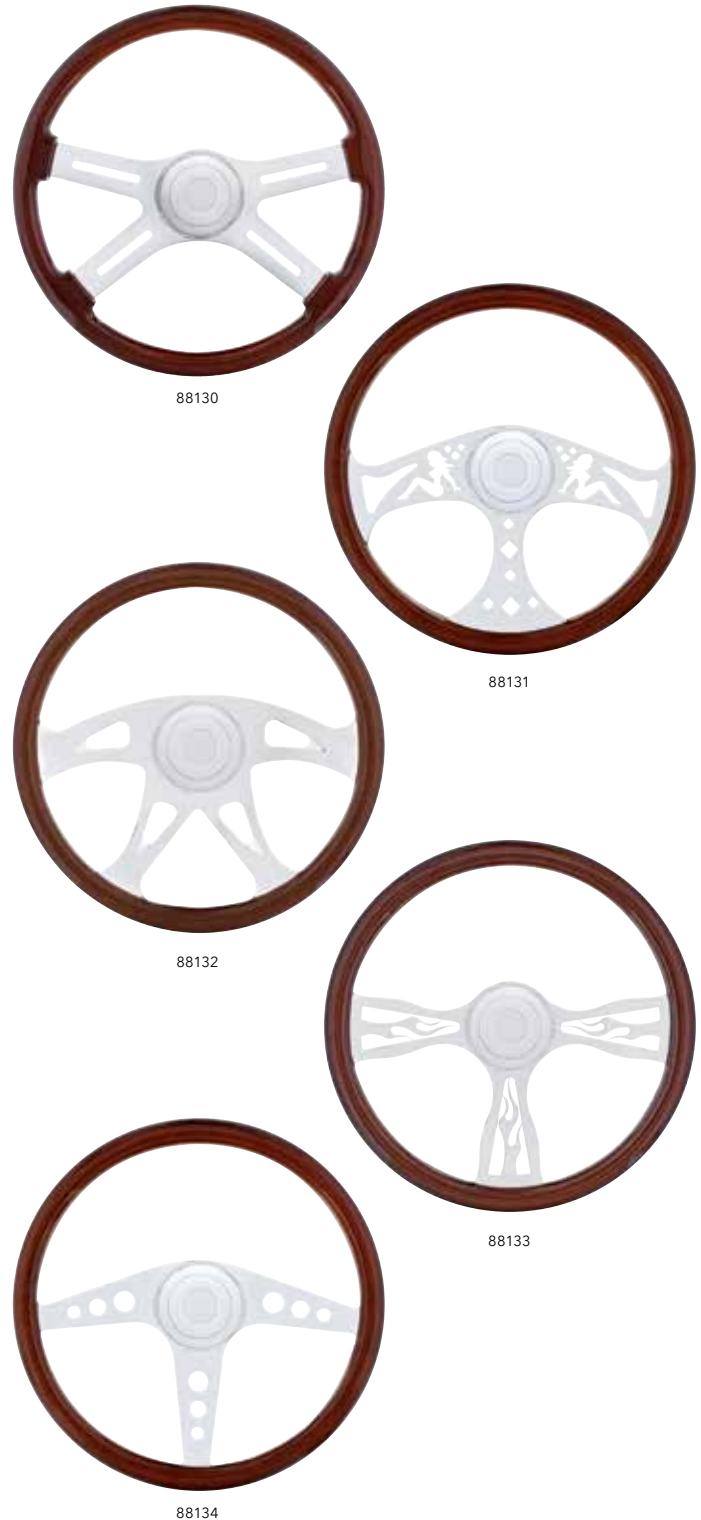

**18" Spoke Steering Wheel - Deluxe**

DESCRIPTION

- 18" Deluxe 4 Spoke Steering Wheel
- Fits Freightliner 1989-July 2006 (Fixed and Adjustable Steering Columns)

Item #	Style	Application	Package	Pack
<b>88116</b>	Economy	1989-07/2006	Boxed	1 Pc./Box



**18" Steering Wheel - Banjo**

DESCRIPTION

- 18" Wood Steering Wheel with Banjo Spokes
- Fits Freightliner 1989-July 2006 (Fixed and Adjustable Steering Columns)

Item #	Style	Application	Package	Pack
<b>88112</b>	Banjo Style	1989-07/2006	1 Pc./Box	1 Pc./Box



**18" Steering Wheel - Skull**

DESCRIPTION

- 18" Wood Steering Wheel with 3D Skull Accent
- Fits Freightliner 1989-July 2006 (Fixed and Adjustable Steering Columns)

Item #	Style	Application	Package	Pack
<b>88128</b>	Skull Style	1989-07/2006	1 Pc./Box	1 Pc./Box



**Hub/Horn Assembly - Freightliner 1989 - July 2006**

DESCRIPTION

- Chrome Hub/Horn Assembly for United Pacific Steering Wheel
- Fits Freightliner 1989-July 2006 (Fixed and Adjustable Steering Columns)

Item #	Description	Package	Pack
<b>88212</b>	Hub/Horn Assembly	Boxed	1 Pc./Box



**Chrome Hub - 2007+ Freightliner**

DESCRIPTION

- 72 Splines, Fits Various 2007+ Freightliner Models
- Chrome Steering Hub for United Pacific Steering Wheels
- Mix and Match with United Pacific Steering Wheels and Designer Horn Bezel for a Unique Look

Item #	Description	Package	Pack
<b>88238</b>	Steering Hub	Boxed	1 Pc./Box



**Chrome Bezel and Horn Button**

DESCRIPTION

- Chrome Aluminum Bezel and Horn Button

Item #	Description	Package	Pack
<b>88261</b>	Bezel & Horn Button	Boxed	1 Pc./Box



**Chrome Skull Horn Button Bezel**

**DESCRIPTION**

- Chrome Skull Horn Button Bezel
- Horn Button Not Included
- Horn Button Available Separately: Item # 88120

Item #	Description	Package	Pack
<b>88216</b>	Skull Steering/Horn Bezel	Carded	1 Pc./Card



**Chrome Flame Horn Button Bezel**

**DESCRIPTION**

- Chrome Flame Horn Button Bezel
- Unique Patent Pending Flame Design
- Horn Button Available Separately: Item # 88120

Item #	Description	Package	P Pack
<b>88223</b>	Flame	Carded	1 Pc./Card



**Steering Wheel Horn Button - Competition Series**

**DESCRIPTION**

- Chrome Aluminum Steering Wheel Horn Button for "Competition Series" Steering Wheel
- Set Includes: Horn Button, UP Aluminum Sticker, and Wires

Item #	Description	Package	Pack
<b>88120</b>	Horn Button	Boxed	1 Set/Box



**Steering Wheel Horn Button**

**DESCRIPTION**

- Chrome Aluminum Steering Wheel Horn Button
- Horn Button Only

Item #	Description	Package	Pack
<b>88016</b>	Horn Button	Carded	1 Pc./Card



**Skull Accent**

**DESCRIPTION**

- Chrome Die Cast Skull Accent, Unique Skull Design
- Mounts to Any Flat Surface, Mounting Screws are Approximately 2 3/4" Apart

Item #	Description	Package	Pack
<b>88122</b>	Skull Accent	Carded	1 Pc./Card



**18" Leather Steering Wheel Cover**

**DESCRIPTION**

- Genuine Leather Steering Wheel Cover
- Easy Installation

Item #	Description	Package	Pack
<b>70111</b>	Black	Boxed	1 Pc./Box
<b>70112</b>	Dark Brown	Boxed	1 Pc./Box





**18" Leather Steering Wheel Cover - Diamond Stitched**

DESCRIPTION

- 18" Black Diamond Stitched Leather Steering Wheel Cover

Item #	Description	Package	Pack
<b>70118</b>	Black Diamond Stitching	Carded	1 Pc./Card
<b>70119</b>	Blue Diamond Stitching	Carded	1 Pc./Card
<b>70120</b>	Red Diamond Stitching	Carded	1 Pc./Card



70118



70119



70120

**18" Leather Steering Wheel Cover - Euro Design**

DESCRIPTION

- 18" Engineered Leather Steering Wheel Covers

- Unique Euro - Tone Two Color Design Comfort Grip

Item #	Description	Package	Pack
<b>70405</b>	Black & Blue	Carded	1 Pc./Card
<b>70406</b>	Black & Red	Carded	1 Pc./Card



70405



70406



**18" Leather Steering Wheel Cover - Euro Design**

DESCRIPTION

- 18" Engineered Leather Steering Wheel Covers

- Unique Euro - Tone Two Color Design Comfort Grip

Item #	Description	Package	Pack
<b>70407</b>	Black	Carded	1 Pc./Card
<b>70408</b>	Blue	Carded	1 Pc./Card
<b>70409</b>	Red	Carded	1 Pc./Card



70407



70408



70409



**20" Steering Wheel Cover**

DESCRIPTION

- 20" Steering Wheel Cover

Item #	Description	Package	Pack
<b>70101</b>	Black	Boxed	1 Pc./Box



**Gun Cylinder Style Steering Wheel Spinner**

DESCRIPTION

- Chrome Aluminum Gun Barrel Steering Wheel Spinner
- Heavy Duty Construction
- Heavy Duty Sealed Ball Bearing Design

Item #	Description	Package	Pack
<b>70106</b>	Steering Wheel Spinner	Carded	1 Pc./Card



**Heavy Duty Steering Wheel Spinner**

DESCRIPTION

- Heavy Duty Aluminum Steering Wheel Spinner
- Tall Shaft Provides Precision Control of Spinner
- Sealed-In Ball Bearings are Encased in Aluminum Waterproof Knob

Item #	Description	Package	Pack
<b>70108</b>	Steering Wheel Spinner	Carded	1 Pc./Card



**Black Steering Wheel Spinner w/ Clear Top**

DESCRIPTION

- Old School Steering Wheel Spinner For That Vintage Look
- Perfect For Classic Cars, Classic Trucks, Hot Rods
- Chrome Die Cast Base With Black Plastic Knob & Clear See Thru Cap
- Removable Clear Cap For Inserting A Picture Or Emblem
- Adjustable Straps Fit Most Steering Wheels With Grip Diameter 3/4" to 1-1/4"
- Not Recommended for Padded Steering Wheels

Item #	Description	Package	Pack
<b>70109</b>	Steering Wheel Spinner	Carded	1 Pc./Card



**Skull Steering Wheel Spinner**

DESCRIPTION

- Skull Steering Wheel Spinner
- Available in Chrome

Item #	Description	Package	Pack
<b>70113</b>	Steering Wheel Spinner	Carded	1 Pc./Card



# STEERING COLUMN ACCESSORIES

## 2007+ Freightliner Steering Column Cover

### DESCRIPTION

- Chrome Plastic Steering Column Cover for 2007 and Newer FL
- Fits Various Freightliner Century, Coronado and Columbia Models

Item #	Description	Package	Pack
<b>42056</b>	Upper Steering Cover	Carded	1 Pc./Card



## Freightliner Cascadia Steering Column Cover

### DESCRIPTION

- Chrome Plastic Lower Steering Column Cover for FL Cascadia
- Fits Various Years and Models

Item #	Description	Package	Pack
<b>42096</b>	Lower Steering Cover	Carded	1 Pc./Card



## Freightliner Upper Steering Column Cover

### DESCRIPTION

- Chrome Plastic Steering Column Cover
- Fits Freightliner Century, Coronado & Columbia
- Includes 2 Chrome Plastic Screw Hole Covers

Item #	Description	Package	Pack
<b>41900</b>	Upper Steering Cover	Carded	1 Set./Card



## 2007+ Freightliner Lower Steering Column Cover

### DESCRIPTION

- Chrome Plastic Lower Steering Column Cover for 2007+ Freightliner
- Fits 2007+ Freightliner Century, Columbia, and Various Other Models
- Double-Sided Tape Mount, Easy Installation

Item #	Description	Package	Pack
<b>42037</b>	Lower Steering Cover	Carded	1 Pc./Card

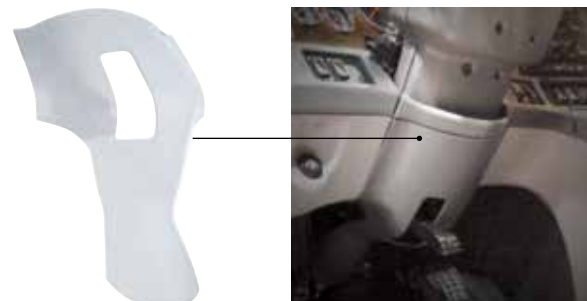

## Freightliner Lower Steering Column Cover

### DESCRIPTION

- Chrome Plastic Lower Steering Column Cover
- Fits Freightliner Century, Coronado & Columbia
- Double-Sided Tape on Back for Easy Installation

Item #	Description	Package	Pack
<b>48102</b>	Lower Steering Cover	Carded	1 Pc./Card



**Freightliner Stainless Lower Steering Column Cover**

DESCRIPTION

- Stainless Steel Lower Steering Column Cover
- Fits Freightliner Classic and FLD

Item #	Description	Package	Pack
<b>21708</b>	Lower Steering Cover	Bulk	1 Pc.



**Freightliner FLD Lower Steering Column Cover**

DESCRIPTION

- Chrome Plastic Freightliner Lower Steering Column Cover

Item #	Description	Package	Pack
<b>48103</b>	Lower Steering Cover	Carded	1 Pc./Card



**Freightliner Cascadia Turn Switch Cover**

DESCRIPTION

- Chrome Plastic Turn Switch Cover for 2007+ Freightliner Cascadia

Item #	Description	Package	Pack
<b>42065</b>	Turn Switch Cover	Carded	1 Set/Card



**Freightliner Turn Signal Lever**

DESCRIPTION

- Chrome Plastic Turn Signal Lever for Freightliner
- Fits Freightliner Century, Coronado & Columbia

Item #	Description	Package	Pack
<b>21059</b>	Turn Signal Lever	Carded	1 Set/Card



**Freightliner Trailer Brake Handle**

DESCRIPTION

- Chrome Plastic Trailer Brake Handle for Freightliner
- Fits Freightliner Century, Coronado & Columbia

Item #	Description	Package	Pack
<b>21058</b>	Trailer Brake Handle	Carded	1 Pc./Card



**Chrome Turn Signal Lever Cover - Diamond**

DESCRIPTION

- Chrome Plastic Turn Signal Lever Cover with Crystal Diamond
- Available in Carded or Bulk

Item #	Style	Jewel Color	Package	Pack
<b>21081</b>	Diamond	Amber	Carded	1 Pc./Card
<b>21082</b>	Diamond	Blue	Carded	1 Pc./Card
<b>21083</b>	Diamond	Clear	Carded	1 Pc./Card
<b>21084</b>	Diamond	Green	Carded	1 Pc./Card
<b>21085</b>	Diamond	Purple	Carded	1 Pc./Card
<b>21086</b>	Diamond	Red	Carded	1 Pc./Card
<b>21080</b>	Indented	-	Carded	1 Pc./Card



**Chrome Turn Signal Lever - OEM Style**

DESCRIPTION

- Chrome Plastic Turn Signal Lever, OEM Style

Item #	Description	Package	Pack
<b>21016</b>	Turn Signal Lever	Carded	1 Set/Card



**4 1/2" Trailer Brake Handle - Diamond**

DESCRIPTION

- 4 1/2" Chrome Aluminum Trailer Brake Handle
- Available with 6 Different Color Diamonds

Item #	Style	Jewel Color	Package	Pack
<b>41041</b>	Diamond	Amber	Carded	1 Pc./Card
<b>41042</b>	Diamond	Blue	Carded	1 Pc./Card
<b>41043</b>	Diamond	Clear	Carded	1 Pc./Card
<b>41044</b>	Diamond	Green	Carded	1 Pc./Card
<b>41045</b>	Diamond	Purple	Carded	1 Pc./Card
<b>41046</b>	Diamond	Red	Carded	1 Pc./Card
<b>41047</b>	Pointed	-	Carded	1 Pc./Card



**Chrome Turn Signal Switch Cover**

DESCRIPTION

- Chrome Plastic Turn Signal Switch Cover
- Available for Grote & Truck-Lit/Signal Stat Turn Signal

Item #	Fit	Package	Pack
<b>21017</b>	Turn Signal Lever Cover	Carded	1 Pc./Card
<b>21019</b>	Truck Lit/Signal Stat Turn Signal	Carded	1 Set/Card



21017



21019

### 7" Trailer Brake Handle - Diamond

DESCRIPTION

- 7" Chrome Aluminum Trailer Brake Handle
- Available with 6 Different Color Diamonds

Item #	Style	Jewel Color	Package	Pack
<b>41028</b>	Diamond	Amber	Carded	1 Pc./Card
<b>41029</b>	Diamond	Blue	Carded	1 Pc./Card
<b>41030</b>	Diamond	Clear	Carded	1 Pc./Card
<b>41031</b>	Diamond	Green	Carded	1 Pc./Card
<b>41032</b>	Diamond	Purple	Carded	1 Pc./Card
<b>41033</b>	Diamond	Red	Carded	1 Pc./Card
<b>41070</b>	Pointed	-	Carded	1 Pc./Card



### 8" Wood Trailer Brake Handle - Diamond

DESCRIPTION

- 8" Chrome Aluminum Trailer Brake Handle with Wood Accent
- Available with 6 Different Color Diamonds

Item #	Style	Jewel Color	Package	Pack
<b>41034</b>	Diamond	Amber	Carded	1 Pc./Card
<b>41035</b>	Diamond	Blue	Carded	1 Pc./Card
<b>41036</b>	Diamond	Clear	Carded	1 Pc./Card
<b>41037</b>	Diamond	Green	Carded	1 Pc./Card
<b>41038</b>	Diamond	Purple	Carded	1 Pc./Card
<b>41039</b>	Diamond	Red	Carded	1 Pc./Card
<b>41040</b>	Pointed	-	Carded	1 Pc./Card



### Trailer Brake Handle

DESCRIPTION

- Chrome Aluminum Trailer Brake Handle

Item #	Description	Package	Pack
<b>23093-1</b>	Trailer Brake Handle	Bulk	1 Pc.

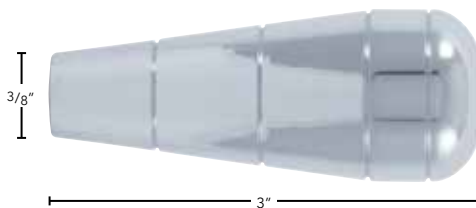

### 5" Wood Trailer Brake Handle

DESCRIPTION

- 5" Chrome Aluminum Trailer Brake Handle with Wood Accent

Item #	Description	Package	Pack
<b>41061</b>	Wood	Carded	1 Pc./Card



### 4 3/4" Steering Column Tilt Handle - Diamond

**DESCRIPTION**

- 4 3/4" Chrome Aluminum Steering Column Tilt Handle
- Available with 6 Different Color Diamonds

Item #	Style	Jewel Color	Package	Pack
<b>41048</b>	Diamond	Amber	Carded	1 Pc./Card
<b>41049</b>	Diamond	Blue	Carded	1 Pc./Card
<b>41050</b>	Diamond	Clear	Carded	1 Pc./Card
<b>41051</b>	Diamond	Green	Carded	1 Pc./Card
<b>41052</b>	Diamond	Purple	Carded	1 Pc./Card
<b>41053</b>	Diamond	Red	Carded	1 Pc./Card
<b>41054</b>	Pointed	-	Carded	1 Pc./Card



### Chrome Tilt Steering Column Knob

**DESCRIPTION**

- Chrome Aluminum Handle Knob

Item #	Description	Package	Pack
<b>23078-1</b>	Tilt Steering Column Knob	Bulk	1 Pc.



# LOWER DASH/FLOOR ACCESSORIES



Foot Pedal  
Pg. 69

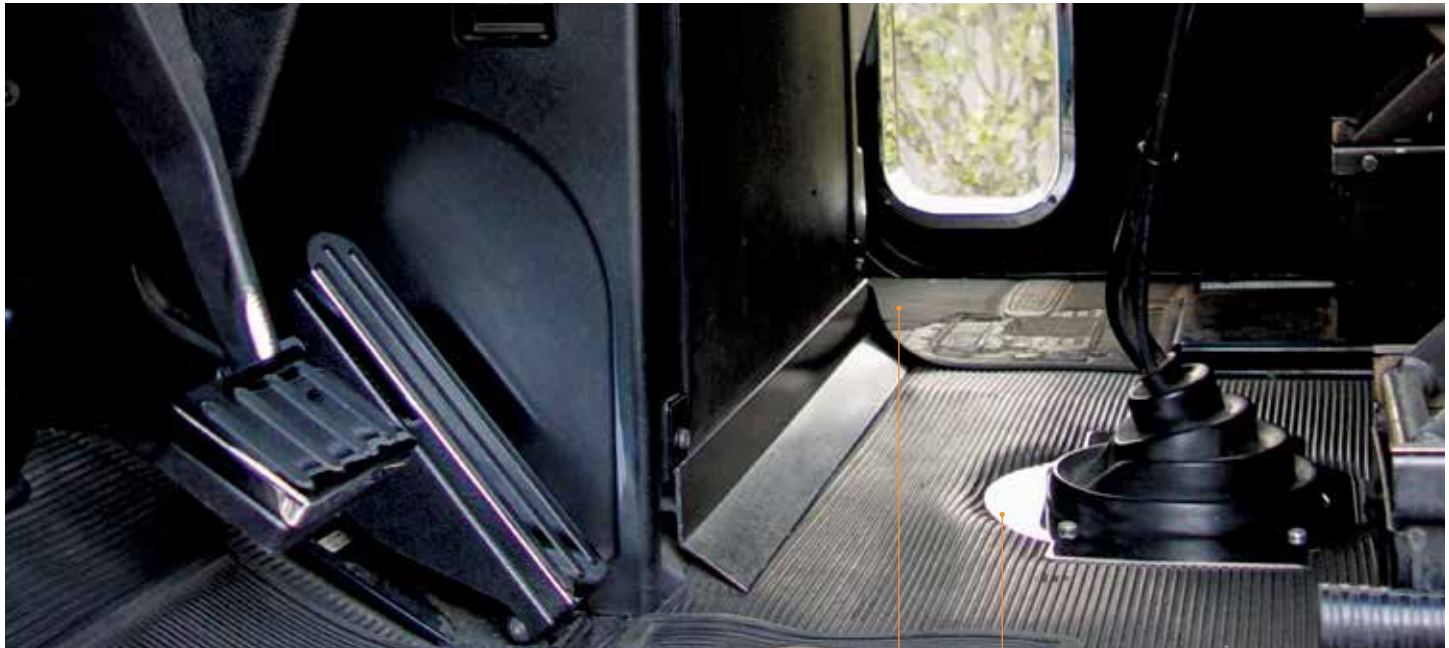

Floor Mat  
Pg. 69

Shift Plate  
Pg. 69



### Freightliner Pedal Set - Diamond

DESCRIPTION

- Fits Various Freightliner Models and Years
- CNC Machined Diamond Design, Ultra High Quality Finish

Item #	Description	Package	Pack
<b>70361</b>	Diamond Foot Pedals	Boxed	1 Set/Box



### Freightliner Pedal Set

DESCRIPTION

- Foot Pedal Set for Freightliner, Includes Gas, Brake, and Clutch Pedals
- Available in Chrome or Anodized Aluminum

#### Chrome Aluminum Pedals

Item #	Finish	Insert	Package	Pack
<b>70259</b>	Chrome	Black Rubber	Boxed	1 Set/Box

#### Anodized Aluminum Pedals

Item #	Finish	Insert	Package	Pack
<b>70292</b>	Blue	Black Rubber	Boxed	1 Set/Box
<b>70293</b>	Red	Black Rubber	Boxed	1 Set/Box



### Freightliner Gearshift Plate

DESCRIPTION

- Gearshift Plate for Freightliner

Item #	Description	Package	Pack
<b>10948</b>	Gearshift Plate	Carded	1 Pc./Card



### Freightliner Floor Mat

DESCRIPTION

- Heavy Duty Floor Mat for Freightliner Century & Columbia
- Sold: Pack = 1 Set (5 Pcs.)

Item #	Description	Package	Pack
<b>91250</b>	Black Floor Mat	Packed	1 Set/Pack



### 12" Shifter Shaft Extension

DESCRIPTION

- Thread On (1/2" - 13 UNC Thread), Thread 1" Long
- 3/4" Diameter Thickness

Item #	Description	Package	Pack
<b>21793</b>	12" Chrome Extension	Carded	1 Pc./Card
<b>21796</b>	12" Gloss Black Extension	Carded	1 Pc./Card
<b>21910</b>	12" Orange Extension	Carded	1 Pc./Card
<b>21911</b>	12" Blue Extension	Carded	1 Pc./Card
<b>21912</b>	12" Green Extension	Carded	1 Pc./Card
<b>21913</b>	12" Silver Extension	Carded	1 Pc./Card
<b>21914</b>	12" White Extension	Carded	1 Pc./Card
<b>21915</b>	12" Pearl White Extension	Carded	1 Pc./Card
<b>21916</b>	12" Yellow Extension	Carded	1 Pc./Card



**Chrome Shifter Shaft Extension**

## DESCRIPTION

- Thread On (1/2" - 13 UNC Thread), Thread 1" Long, 3/4" Diameter
- For Off-Road and Show Use Only

Item #	Description	Package	Pack
<b>21792</b>	6" Extension	Carded	1 Pc./Card
<b>21795</b>	9" Extension	Carded	1 Pc./Card
<b>21793</b>	12" Extension	Carded	1 Pc./Card
<b>21794</b>	18" Extension	Carded	1 Pc./Card

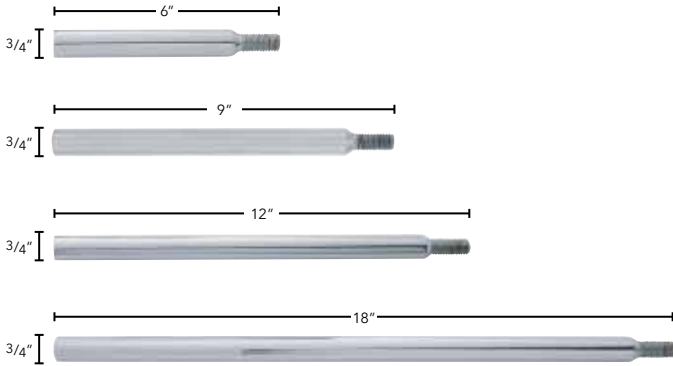
**Black Shifter Shaft Extender**

## DESCRIPTION

- Thread On (1/2" - 13 UNC Thread), Thread 1" Long, 3/4" Diameter

Item #	Description	Package	Pack
<b>21796</b>	12" Extension	Carded	1 Pc./Card
<b>21797</b>	18" Extension	Carded	1 Pc./Card

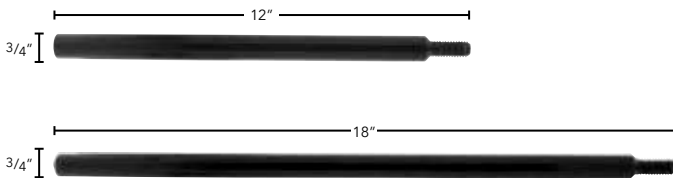
**Skull Shifter Shaft Extender**

## DESCRIPTION

- Thread On (1/2" - 13 UNC Thread), Thread 1" Long, 3/4" Diameter
- For Off-Road and Show Use Only

Item #	Description	Package	Pack
<b>21798</b>	12" Extension	Carded	1 Pc./Card
<b>21799</b>	18" Extension	Carded	1 Pc./Card

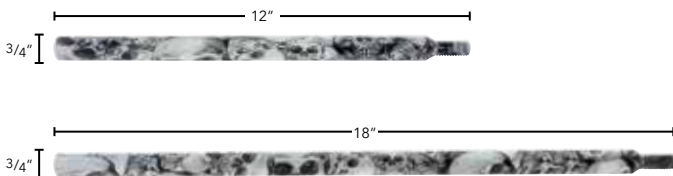
**Chrome Splitter Button**

## DESCRIPTION

- Chrome Splitter Button for Eaton Fuller Shifter
- Available for Eaton Fuller 13 and 15 Speed Shifter

Item #	Description	Speed	Pack
<b>70265</b>	Fits Eaton A-6913	13	1 Pc./Card
<b>70270</b>	Fits Eaton A-6915	15	1 Pc./Card

**Chrome Range Selector Cover**

## DESCRIPTION

- Chrome Plastic Range Selector Cover for Eaton Fuller Shift Knobs

Item #	Description	Package	Pack
<b>70273</b>	Fits Eaton Fuller Shifter	Carded	1 Pc./Card

**Gearshift Knob Cover**

**DESCRIPTION**

- Gearshift Knob Cover for United Pacific Shifter Knob Only
- Available in Stainless Steel or Wood

Item #	Description	Package	Pack
<b>70176-2</b>	Stainless Steel Cover	Carded	1 Pc./Card
<b>70176-1</b>	Wood Cover	Carded	1 Pc./Card



**Wood "T" Shape Gearshift Knob**

**DESCRIPTION**

- Hand-Crafted Wood "T" Shape Gearshift Knob
- Available Carded Only

Item #	Description	Package	Pack
<b>70178</b>	Wood "T" Shape Knob	Carded	1 Pc./Card



**Chrome Gun Barrel Gearshift Knob**

**DESCRIPTION**

- Chrome Gun Barrel Gearshift Knob for Eaton Fuller Transmissions
- Available for 9/10 or 13/18 Speed Eaton Fuller Transmissions

Item #	Description	Package	Pack
<b>70228</b>	9/10 Speed Gun Barrel	Carded	1 Pc./Card
<b>70229</b>	13/18 Speed Gun Barrel	Carded	1 Pc./Card



**Gearshift Knob**

**DESCRIPTION**

- Chrome Plastic 13/18 Eaton Fuller Gearshift Knob
- A Little Larger than OEM Shift Knob for a More Solid Feel and Grip

Item #	Description	Package	Pack
<b>70169</b>	13/18 Speed Eaton Fuller	Carded	1 Pc./Card



**Gearshift Knob**

**DESCRIPTION**

- Eaton Fuller Gearshift Knob, Gearshift Cover Available Separately
- Available in Chrome Aluminum or Hand Crafted Wood
- Available for 9/10 & 13/18 Speed Eaton Fuller Transmissions

**Chrome Gearshift Knob**

Item #	Description	Package	Pack
<b>70177</b>	9/10 Speed Eaton Fuller	Carded	1 Pc./Card
<b>70176</b>	13/18 Speed Eaton Fuller	Carded	1 Pc./Card

**Wood Gearshift Knob**

Item #	Description	Package	Pack
<b>70174</b>	9/10 Speed Eaton Fuller	Carded	1 Pc./Card
<b>70173</b>	13/18 Speed Eaton Fuller	Carded	1 Pc./Card

**Leather Gearshift Knob**

Item #	Description	Package	Pack
<b>70175</b>	9/10 Speed Eaton Fuller	Carded	1 Pc./Card



**LED Shift Knob - 13/15/18 Speed**

## DESCRIPTION

- Designer Style shift Knobs for 13/15/18 Speed Gearshift Knobs with LEDs
- CNC-Machined Grip, LEDs Available in 4 Different Colors
- Available in Chrome or Matte Black Finish

**Daytona**

Item #	LED	Speed	Finish	Pack
<b>70712</b>	Amber	13/15/18	Chrome	1 Pc./Card
<b>70713</b>	Red	13/15/18	Chrome	1 Pc./Card
<b>70714</b>	Blue	13/15/18	Chrome	1 Pc./Card
<b>70715</b>	White	13/15/18	Chrome	1 Pc./Card

**Daytona Black**

Item #	LED	Speed	Finish	Pack
<b>70716</b>	Amber	13/15/18	Black	1 Pc./Card
<b>70717</b>	Red	13/15/18	Black	1 Pc./Card
<b>70718</b>	Blue	13/15/18	Black	1 Pc./Card
<b>70719</b>	White	13/15/18	Black	1 Pc./Card

**Brooklyn**

Item #	LED	Speed	Finish	Pack
<b>70720</b>	Amber	13/15/18	Chrome	1 Pc./Card
<b>70721</b>	Red	13/15/18	Chrome	1 Pc./Card
<b>70722</b>	Blue	13/15/18 </td <td>Chrome</td> <td>1 Pc./Card</td>	Chrome	1 Pc./Card
<b>70723</b>	White	13/15/18	Chrome	1 Pc./Card

**Austin**

Item #	LED	Speed	Finish	Pack
<b>70724</b>	Amber	13/15/18	Chrome	1 Pc./Card
<b>70725</b>	Red	13/15/18	Chrome	1 Pc./Card
<b>70726</b>	Blue	13/15/18	Chrome	1 Pc./Card
<b>70727</b>	White	13/15/18	Chrome	1 Pc./Card



70712



70717



70722



70727

**Chrome LED 13/15/18 Speed Gearshift Mounting Adapter**

## DESCRIPTION

- Chrome Diecast LED Gearshift Mounting Adapter, Vertical Mount
- Fits with 13/15/18 Gearshift Knobs
- LED Light Available Separately, Item # 36897-98, 36905-36908
- **Patent Pending**

Item #	Description	Speed	Pack
<b>70664B</b>	LED Gear Shift Mounting Adapter	13/18	1 Pc./Card



**Chrome LED 9 Speed Gearshift Mounting Adapter**

DESCRIPTION

- Chrome Diecast LED Gearshift Mounting Adapter, Vertical Mount
- Fits with 9 Gearshift Knobs
- LED Light Available Separately, Item # 36897-98, 36905-36908
- Patent Pending

Item #	Description	Speed	Pack
<b>70665B</b>	LED Gear Shift Mounting Adapter	9	1 Pc./Card



**LED Shift Knob - 9 Speed**

DESCRIPTION

- Designer Style Shift Knobs for 9 Speed Gearshift Knobs with LEDs
- CNC-Machined Grip, LEDs Available in 4 Different Colors
- Available in Chrome or Matte Black Finish

**Daytona**

Item #	LED	Speed	Finish	Pack
<b>70728</b>	Amber	13/15/18	Chrome	1 Pc./Card
<b>70729</b>	Red	13/15/18	Chrome	1 Pc./Card
<b>70730</b>	Blue	13/15/18	Chrome	1 Pc./Card
<b>70731</b>	White	13/15/18	Chrome	1 Pc./Card

**Daytona Black**

Item #	LED	Speed	Finish	Pack
<b>70732</b>	Amber	13/15/18	Black	1 Pc./Card
<b>70733</b>	Red	13/15/18	Black	1 Pc./Card
<b>70734</b>	Blue	13/15/18	Black	1 Pc./Card
<b>70735</b>	White	13/15/18	Black	1 Pc./Card

**Brooklyn**

Item #	LED	Speed	Finish	Pack
<b>70736</b>	Amber	13/15/18	Chrome	1 Pc./Card
<b>70737</b>	Red	13/15/18	Chrome	1 Pc./Card
<b>70738</b>	Blue	13/15/18	Chrome	1 Pc./Card
<b>70739</b>	White	13/15/18	Chrome	1 Pc./Card

**Austin**

Item #	LED	Speed	Finish	Pack
<b>70740</b>	Amber	13/15/18	Chrome	1 Pc./Card
<b>70741</b>	Red	13/15/18	Chrome	1 Pc./Card
<b>70742</b>	Blue	13/15/18	Chrome	1 Pc./Card
<b>70743</b>	White	13/15/18	Chrome	1 Pc./Card



70728



70733



70738



70743

**Designer 13/15/18 Speed Shift Knob - Vertical**

DESCRIPTION

- Chrome Designer Gearshift Knob, CNC-Machined Grip
- Fits 13/15/18 Speed Gearshift Knobs, Vertical Mount
- Mounting Adapter (Item # 70604B) and Grips Available Separately
- Patent Pending

Item #	Style	Mount	Package	Pack
<b>70650</b>	Austin	Vertical	Carded	1 Pc./Card
<b>70649</b>	Brooklyn	Vertical	Carded	1 Pc./Card
<b>70624</b>	Dallas	Vertical	Carded	1 Pc./Card
<b>70609</b>	Daytona	Vertical	Carded	1 Pc./Card
<b>70587</b>	Black Daytona	Vertical	Carded	1 Pc./Card
<b>70628</b>	Talladega	Vertical	Carded	1 Pc./Card
<b>70610</b>	Vegas	Vertical	Carded	1 Pc./Card

**Chrome 13/15/18 Speed Gearshift Mounting Adapter**

DESCRIPTION

- Chrome Diecast Gearshift Mounting Adapter, Vertical Mount
- Fits 13/15/18 Speed Gearshift Knobs
- Fits United Pacific CNC-Machined Grip, Item # 70601B & # 70602B
- Patent Pending

Item #	Description	Speed	Pack
<b>70604B</b>	15/16" Top Mount Adapter	13/18	1 Pc./Box



70650



70649



70609



70587



70628



70624



70610

**New Packaging**

### Chrome 13/15/18 Speed Gearshift Mounting Adapter - Horizontal

**DESCRIPTION**

- Chrome Diecast Gearshift Mounting Adapter, Horizontal Mount
- Fits 13/15/18 Speed Gearshift Knobs
- Fits United Pacific CNC-Machined Grip, Item # 70601B & # 70602B
- Patent Pending

Item #	Description	Speed	Pack
<b>70600B</b>	15/16" Side Mount Adapter	13/18	1 Pc./Box



### Designer 13/15/18 Speed Shift Knob - Horizontal

**DESCRIPTION**

- Chrome Designer Gearshift Knob, CNC-Machined Grip
- Fits 13/15/18 Speed Gearshift Knobs
- Mounting Adapter (Item # 70600B) and Grips Available Separately
- Patent Pending

Item #	Style	Mount	Package	Pack
<b>70648</b>	Austin	Horizontal	Carded	1 Pc./Card
<b>70647</b>	Brooklyn	Horizontal	Carded	1 Pc./Card
<b>70623</b>	Dallas	Horizontal	Carded	1 Pc./Card
<b>70607</b>	Daytona	Horizontal	Carded	1 Pc./Card
<b>70588</b>	Black Daytona	Horizontal	Carded	1 Pc./Card
<b>70627</b>	Talladega	Horizontal	Carded	1 Pc./Card
<b>70608</b>	Vegas	Horizontal	Carded	1 Pc./Card

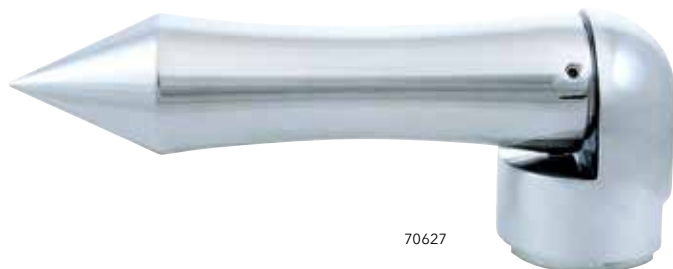

70627

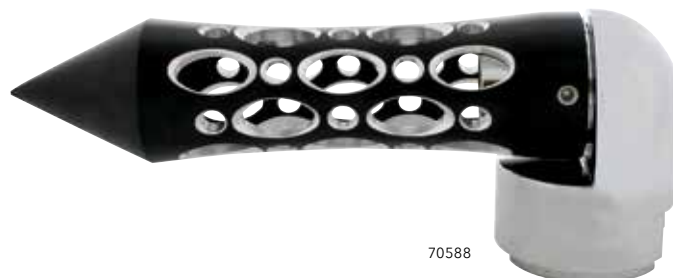

70588



70608



70607



70623



70647



**New Packaging**



70648

**T Grip 13/15/18 Speed Shift Knob**

## DESCRIPTION

- T Shift Knob for 13/15/18 Speed Gearshift Knob
- 1" Top Mount Gearshift Mounting Adapter
- Mounting Adapter, Item # 70604B and T Shift Knob: Item #70666 Available Separately
- Patent Pending

Item #	Description	Speed	Pack
<b>70692</b>	"T" Shift Knob	13/15/18	1 Pc./Card

**Chrome 13/15/18 Speed Gearshift Mounting Adapter - 7/16" Vertical**

## DESCRIPTION

- Chrome Diecast Gearshift Mounting Adapter
- Fits 13/15/18 Speed Gearshift Knobs
- Patent Pending

Item #	Description	Speed	Pack
<b>70603B</b>	7/16" Top Mount Adapter	13/18	1 Pc./Card

**Pistol Grip 13/15/18 Speed Shift Knob**

## DESCRIPTION

- Chrome Pistol Grip Shift Knob, Fits 13/15/18 Speed Gearshift Knobs
- Available in Chrome or Black
- Mounting Adapter (Item # 70603B) and Grips Available Separately
- Patent Pending

Item #	Style	Finish	Package	Pack
<b>70655</b>	Skulls	Chrome	Carded	1 Pc./Card
<b>70668</b>	Skulls	Black	Carded	1 Pc./Card
<b>70744</b>	Skulls	Chrome/Black	Carded	1 Pc./Card
<b>70683</b>	"Gatling"	Chrome	Carded	1 Pc./Card
<b>70693</b>	"Gatling"	Black	Carded	1 Pc./Card
<b>70684</b>	"Slot"	Chrome	Carded	1 Pc./Card
<b>70694</b>	"Slot"	Black	Carded	1 Pc./Card
<b>70636</b>	"Challenger"	Chrome	Carded	1 Pc./Card
<b>70667</b>	"Challenger"	Black	Carded	1 Pc./Card



**New Packaging**



### Skull 13/15/18 Speed Shift Knob

**DESCRIPTION**

- Skull Style Shift Knob for 13/15/18 Speed Gearshift Knob
- Zinc Die-Casted, Available in Chrome or Matte Black Finish
- Mounting Adapter: Item # 70603B, Skull Knob: Item # 70681 (Chrome) /70699 (Black) Available Separately
- Patent Pending

Item #	Style	Finish	Package	Pack
<b>70709</b>	Skull	Chrome	Carded	1 Pc./Card
<b>70710</b>	Skull	Black	Carded	1 Pc./Card



### Knuckle 13/15/18 Speed Shift Knob

**DESCRIPTION**

- Knuckle Style Shift Knob for 13/15/18 Speed Gearshift Knob
- Zinc Die-Casted, Available in Chrome or Matte Black Finish
- Mounting Adapter, Item # 70603B and Knuckle Knob: Item # 70690 (Black)/70652 (Chrome) Available Separately
- Patent Pending

Item #	Style	Finish	Package	Pack
<b>70598</b>	Knuckle	Black	Carded	1 Pc./Card
<b>70599</b>	Knuckle	Chrome	Carded	1 Pc./Card



### Biker Skull 13/15/18 Speed Shift Knob

**DESCRIPTION**

- Chrome Biker Skull Shift Knob, CNC-Machined Aluminum Grip
- Fits 13/15/18 Speed Gearshift Knobs, Available in Chrome or Black
- Mounting Adapter (Item # 70603B) and Skull Biker Knob Available Separately
- Patent Pending

Item #	Style	Finish	Package	Pack
<b>70642</b>	Skull Biker	Chrome	Boxed	1 Pc./Box
<b>70669</b>	Skull Biker	Black	Boxed	1 Pc./Box



### 50 Caliber Bullet 13/15/18 Speed Shift Knob

**DESCRIPTION**

- 50 Caliber Bullet Shift Knob for 13/15/18 Speed Gearshift Knob
- 13/15/18 Mounting Adapter: Item # 70603B, and Bullet Knob: Item # 70674, Available Separately

Item #	Description	Package	Pack
<b>70590</b>	13/15/18 Bullet Shift Knob	Carded	1 Pc./Card



**Dagger 13/15/18 Speed Shift Knob**

## DESCRIPTION

- Dagger Style Shift Knob for 13/15/18 Speed Gearshift Knob
- Available in Dagger or Skull Dagger Style
- Mounting Adapter (Item # 70603B), Dagger Knob (item # 70677), and Skull Dagger Knob (Item # 70679) Available Separately
- Patent Pending

Item #	Style	Finish	Package	Pack
<b>70695</b>	Dagger	Chrome	Carded	1 Pc./Card
<b>70696</b>	Skull	Chrome	Carded	1 Pc./Card



70695



70696

**USMC Fighting Knife 13/15/18 Speed Shift Knob**

## DESCRIPTION

- Chrome USMC Fighting Knife Shift Knob, CNC-Machined Aluminum Grip
- Fits 13/15/18 Speed Gearshift Knobs
- Mounting Adapter (Item # 70603B) and "USMC Fighting Knife" (Item # 70630B) Available Separately
- Patent Pending

Item #	Description	Package	Pack
<b>70637</b>	"USMC" Shift Knob	Boxed	1 Pc./Box

**Dice 13/15/18 Speed Shift Knob**

## DESCRIPTION

- Dice Shift Knob, Fits 13/15/18 Speed Gearshift Knobs
- Mounting Adapter (Item # 70603B) and Dice Knob Available Separately

Item #	Style	Finish	Package	Pack
<b>70654</b>	Dice	Chrome	Boxed	1 Pc./Box
<b>70615</b>	Dice	Red	Boxed	1 Pc./Box
<b>70616</b>	Dice	White	Boxed	1 Pc./Box
<b>70617</b>	Dice	Black	Boxed	1 Pc./Box
<b>70618</b>	Dice	Blue	Boxed	1 Pc./Box



70654



70615



70617



70618



70616

**Chrome Ball 13/15/18 Speed Shift Knob**

## DESCRIPTION

- Chrome Ball Shift Knob, Fits 13/15/18 Speed Gearshift Knobs
- Mounting Adapter (Item # 70603B) and Gearshift Knob (UP Item # 70606B)

Item #	Description	Package	Pack
<b>70612</b>	Ball Shift Knob	Boxed	1 Pc./Box



### 8 Ball 13/15/18 Speed Shift Knob

DESCRIPTION

- 8 Ball Shift Knob, Fits 13/15/18 Speed Gearshift Knobs
- Mounting Adapter (Item # 70603B) and Gearshift Knob Available Separately

Item #	Description	Package	Pack
<b>70685</b>	8 Ball Shift Knob	Carded	1 Pc./Card
<b>70686</b>	Glitter 8 Ball Shift Knob	Carded	1 Pc./Card



### Chrome Shift Knob Adapter - 5/16-24 SAE Thread

DESCRIPTION

- Chrome Aluminum Shift Knob Adapter, 5/16-24 SAE Thread
- For Custom Installation Use Only

Item #	Description	Package	Pack
<b>70635B</b>	Shift Knob Adapter	Bulk	1 Pc.



### Pool Ball 13/15/18 Speed Shift Knob

DESCRIPTION

- Pool Ball Gearshift Knob for 13/15/18 Speed
- Includes Mounting Adapter: Item # 70603B for Easy Installation

Item #	Description	Package	Pack
<b>70687</b>	#1 Pool Ball Shift Knob	Carded	1 Pc./Card
<b>70688</b>	#2 Pool Ball Shift Knob	Carded	1 Pc./Card
<b>70689</b>	#3 Pool Ball Shift Knob	Carded	1 Pc./Card



### Designer Shift Knob 5/16-24 SAE Thread

DESCRIPTION

- Custom Chrome Shift Knobs with Designer Grip
- Universal 5/16-24 SAE Thread, Perfect for Passenger Vehicles and Pick-Ups

Item #	Description	Package	Pack
<b>70670</b>	"Austin" Shift Knob	Carded	1 Pc./Card
<b>70671</b>	"Brooklyn" Shift Knob	Carded	1 Pc./Card
<b>70638</b>	"Dallas" Shift Knob	Carded	1 Pc./Card
<b>70639</b>	"Daytona" Shift Knob	Carded	1 Pc./Card
<b>70640</b>	"Talladega" Shift Knob	Carded	1 Pc./Card
<b>70641</b>	"Vegas" Shift Knob	Carded	1 Pc./Card



### Baseball 13/15/18 Speed Shift Knob

DESCRIPTION

- 2 1/4" Diameter Baseball Gearshift Knob, Fits 13/15/18 Speed Gearshift Knobs
- Mounting Adapter Available Separately

Item #	Description	Package	Pack
<b>70620</b>	Baseball Shift Knob	Carded	1 Pc./Card



**T Grip Shift Knob 5/16-24 SAE Thread**

DESCRIPTION

- Chrome "T" Shift Knob, Vertical Mount, CNC-Machined Grip
- Designed for Custom Modification of Modern Single Stick Shifter to Old School Dual Stick Shift System
- Mounting Adapter Item # 70625B And "T" Shift Knob Grip Item # 70653 Available Separately

Item #	Description	Package	Pack
<b>70697</b>	T Shift Knob	Carded	1 Pc./Card



**Chrome Designer Grip**

DESCRIPTION

- Chrome Aluminum Replacement "Designer" Grip for UP Shift Knobs
- CNC-Machined Grip, 1" Round Opening, Hex Screw Mount
- Mounting Adapter (Item # 70600B & # 70604B) Available Separately

Item #	Description	Package	Pack
<b>70645B</b>	"Austin" Gun Cylinder Grip	Bulk	1 Pc./Bulk
<b>70644B</b>	"Brooklyn" Spike Grip	Bulk	1 Pc./Bulk
<b>70622B</b>	"Dallas" Grooved Grip	Bulk	1 Pc./Bulk
<b>70601B</b>	"Daytona" Spike Grip	Bulk	1 Pc./Bulk
<b>70691</b>	Black "Daytona" Spike Grip	Bulk	1 Pc./Bulk
<b>70621B</b>	"Talladega" Spike Grip	Bulk	1 Pc./Bulk
<b>70602B</b>	"Vegas" Grooved Grip	Bulk	1 Pc./Bulk



70645B

70644B

70601B

70691

70622B

70621B

70602B

**Pistol Grip Shift Knob**

DESCRIPTION

- Aluminum Pistol Grip Shift Knob, Universal Design
- Ultra High Quality Finish in Chrome or Black, CNC-Machined Grip
- Universal Hex Screw Mount Design, Includes Mounting Hardware

Item #	Style	Finish	Package	Pack
<b>70626</b>	"Challenger"	Chrome	Carded	1 Pc./Card
<b>70656</b>	"Challenger"	Black	Carded	1 Pc./Card
<b>70646</b>	Skulls	Chrome	Carded	1 Pc./Card
<b>70657</b>	Skulls	Black	Carded	1 Pc./Card
<b>70711</b>	Skulls	Black / Chrome	Carded	1 Pc./Card
<b>70651</b>	"Gatling"	Chrome	Carded	1 Pc./Card
<b>70672</b>	"Gatling"	Black	Carded	1 Pc./Card
<b>70659</b>	"Slot"	Chrome	Carded	1 Pc./Card
<b>70673</b>	"Slot"	Black	Carded	1 Pc./Card

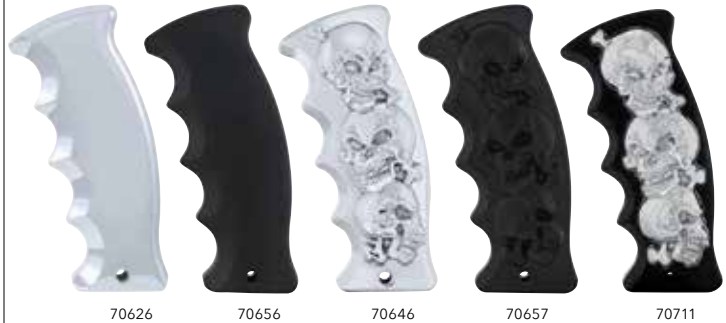

70626

70656

70646

70657

70711



70651

70672

70659

70673

**T Grip Shift Knob - 1" Mount**

DESCRIPTION

- Ultra High Quality Finish, Fits United Pacific Mounting Adapter Only
- Heavy Duty Construction Ensures Strength and Durability

Item #	Description	Package	Pack
<b>70666</b>	T Shift Knob	Carded	1 Pc./Card



1"

**Biker Skull Shift Knob**

DESCRIPTION

- Aluminum Biker Skull Shift Knob, Ultra High Quality Finish
- CNC-Machined Grip, Approximately 2" x 2 3/4"
- Universal Hex Screw Mount Design, Includes Mounting Hardware

Item #	Style	Finish	Package	Pack
<b>70629B</b>	Skulls	Chrome	Boxed	1 Pc.
<b>70658</b>	Skulls	Black	Boxed	1 Pc.



**USMC Fighting Knife Shift Knob**

DESCRIPTION

- Chrome USMC Fighting Knife Shift Knob, CNC-Machined Aluminum Grip
- For Passenger Vehicles, SUVs, and Pick-Ups, High Quality Chrome Finish
- Universal Hex Screw Mount Design, Includes Mounting Hardware

Item #	Description	Package	Pack
<b>70630B</b>	"USMC" Shift Knob	Bulk	1 Pc.



**T Grip Shift Knob 9/16"**

DESCRIPTION

- Ultra High Quality Finish
- Universal Hex Screw Mount Design, Includes Mounting Hardware

Item #	Description	Package	Pack
<b>70653</b>	"T" Shift Knob	Carded	1 Pc./Card



**50 Caliber Bullet Shift Knob**

DESCRIPTION

- 50 Caliber Bullet Style Shift Knob
- Ultra High Quality Aluminum Alloy and Bronze Finish
- Universal Hex Screw Mount Design

Item #	Description	Package	Pack
<b>70674</b>	Bullet Shift Knob	Carded	1 Pc./Card



**Knuckle Shift Knob**

DESCRIPTION

- Zinc Die-Casted, Available in Chrome or Matte Black Finish
- Universal Hex Screw Mount Design, Includes Mounting Hardware

Item #	Style	Finish	Package	Pack
<b>70690</b>	Knuckle	Black	Carded	1 Pc./Card
<b>70652</b>	Knuckle	Chrome	Carded	1 Pc./Card



70690



70652

**Dagger Shift Knob**

## DESCRIPTION

- Available in Dagger or Skull Dagger Style
- Ultra High Quality Chrome Finish, Machined Grip
- Universal Hex Screw Mount Design, Includes Mounting Hardware

Item #	Style	Finish	Package	Pack
<b>70677</b>	Dagger	Chrome	Carded	1 Pc./Card
<b>70679</b>	Skull	Chrome	Carded	1 Pc./Card



70677



70679

**Chrome Ball Shift Knob**

## DESCRIPTION

- 2 1/4" Chrome Ball Gearshift Knob
- 1/2" Dia. Stem with 5/16" and 3/8" Nylon Insert, Includes Mounting Hardware

Item #	Description	Package	Pack
<b>70606B</b>	Chrome Ball Shift Knob	Carded	1 Pc./Card

**Chrome Dice Shift Knob**

## DESCRIPTION

- Chrome Dice Shift Knob, Ultra High Quality Chrome Finish
- Universal Hex Screw Mount Design, Includes Mounting Hardware

Item #	Description	Package	Pack
<b>70605</b>	Dice Shift Knob	Carded	1 Pc./Card

**8 Ball Shift Knob**

## DESCRIPTION

- 8 Ball Gearshift Knob
- Brushed Aluminum Mounting Base Adapter
- Hex Screw Mount Design, Includes Nylon Reducing Bushings to Fit Smaller Shifters

Item #	Description	Package	Pack
<b>70660</b>	"Glitter" 8 Ball	Carded	1 Pc./Card
<b>70025</b>	8 Ball	Carded	1 Pc./Card



70660



70025

**Pool Ball Shift Knob**

## DESCRIPTION

- Pool Ball Gearshift Knob
- Brushed Aluminum Mounting Base Adapter
- Hex Screw Mount Design, Includes Nylon Reducing Bushings to Fit Smaller Shifters

Item #	Description	Package	Pack
<b>70661</b>	Number 1 Ball	Carded	1 Pc./Card
<b>70662</b>	Number 2 Ball	Carded	1 Pc./Card
<b>70663</b>	Number 3 Ball	Carded	1 Pc./Card



70661



70662



70663

### Dice Shift Knob

#### DESCRIPTION

- Dice Gearshift Knob, Approximate 1 7/8" x 1 7/8"
- Universal Hex Screw Mount Design, Includes Mounting Hardware

Item #	Style	Color	Package	Pack
<b>70013</b>	Dice	Red	Bulk	1 Pc./Bulk
<b>70014</b>	Dice	White	Bulk	1 Pc./Bulk
<b>70015</b>	Dice	Black	Bulk	1 Pc./Bulk
<b>70016</b>	Dice	Blue	Bulk	1 Pc./Bulk



## New Item!

### 13/15/18 Speed Gearshift Knob

#### DESCRIPTION

- 13/15/18 Speed Gearshift Knob for Eaton Fuller Shift Knob Assemblies
- Premium Automotive Paint in Vibrant Candy Colors, Bold Effects and Dazzling Color

Item #	Description	Package	Pack
<b>70591</b>	Cadmium Orange	Carded	1 Pc./Card
<b>70592</b>	Indigo Blue	Carded	1 Pc./Card
<b>70593</b>	Emerald Green	Carded	1 Pc./Card
<b>70594</b>	Candy Red	Carded	1 Pc./Card
<b>70595</b>	Liquid Silver	Carded	1 Pc./Card
<b>70596</b>	Pearl White	Carded	1 Pc./Card
<b>70597</b>	Electric Yellow	Carded	1 Pc./Card



### Wood "T" Shape Gearshift Knob

#### DESCRIPTION

- Hand-Crafted Wood "T" Shape Gearshift Knob
- Available Carded Only

Item #	Description	Package	Pack
<b>70178</b>	Wood "T" Shape Knob	Carded	1 Pc./Card



### Chrome Lower Gearshift Knob Cover

#### DESCRIPTION

- Chrome Lower Gearshift Knob Cover
- Available in Chrome Plastic or Chrome Steel

Item #	Description	Package	Pack
<b>41021</b>	Chrome Plastic Cover	Bulk	1 Pc./Bulk
<b>41069</b>	Chrome Steel Cover	Bulk	1 Pc./Bulk



### Freightliner Cascadia Dash Hook

#### DESCRIPTION

- Chrome Plastic Dash Hook for 2007+ Freightliner Cascadia
- Installation Requires the OEM Hook to Be Unscrewed From the Back Side of the Dash, Do Not Attempt to Pull the OEM Hook Out from the Front

Item #	Description	Package	Pack
<b>42309</b>	Dash Hook	Carded	1 Pc./Card



**Shifter Boot**

DESCRIPTION

- Vinyl Shifter Boot
- Available in 17" and 30" Long Boot

Item #	Size	Color	Package	Pack
<b>91001</b>	17"	Black	Carded	1 Pc./Card
<b>91011</b>	30"	Black	Carded	1 Pc./Card



**Chrome Air Valve Set**

DESCRIPTION

- Chrome Air Valve Set for Train Horns
- Includes Air Valve Lever and Stand
- Stand Available in 4", 9", or 11" Tall

Item #	Description	Package	Pack
<b>46106</b>	4" Valve Set	Shell Packed	1 Set/Shell
<b>46111</b>	9" Valve Set	Shell Packed	1 Set/Shell
<b>46112</b>	11" Valve Set	Shell Packed	1 Set/Shell



**Chrome Air Valve Lever**

DESCRIPTION

- Chrome Air Valve for United Pacific Valve Set
- Manual Air Valve Lever for Train Horn

Item #	Description	Package	Pack
<b>46111-2</b>	Air Valve Lever	Boxed	1 Pc./Box



**Chrome Air Valve Stand**

DESCRIPTION

- Chrome Air Valve Stand for United Pacific Air Valve Set
- Available in 9" or 11" Tall Stand

Item #	Description	Package	Pack
<b>46111-1</b>	9" Stand	Boxed	1 Pc./Box
<b>46112-1</b>	11" Stand	Boxed	1 Pc./Box





### Chrome Designer Air Valve Set

DESCRIPTION

- Chrome Air Horn Valve Lever Set with Designer Grip
- Floor Mount Stand Available 11, 9, and 4 Tall
- Includes Air Horn Valve Lever and Stand

#### 11" Air Horn Valve

Item #	Grip	Grip #	Stand Size	Pack
45980	"Austin"	70645B	11"	1 Set/Box
45979	"Brooklyn"	70644B	11"	1 Set/Box
45978	"Dallas"	70622B	11"	1 Set/Box
45975	"Daytona"	70601B	11"	1 Set/Box
45977	"Talladega"	70621B	11"	1 Set/Box
45976	"Vegas"	70602B	11"	1 Set/Box

#### 9" Air Horn Valve

Item #	Grip	Grip #	Stand Size	Pack
45986	"Austin"	70645B	9"	1 Set/Box
45985	"Brooklyn"	70644B	9"	1 Set/Box
45984	"Dallas"	70622B	9"	1 Set/Box
45981	"Daytona"	70601B	9"	1 Set/Box
45983	"Talladega"	70621B	9"	1 Set/Box
45982	"Vegas"	70602B	9"	1 Set/Box

#### 4" Air Horn Valve

Item #	Grip	Grip #	Stand Size	Pack
45992	"Austin"	70645B	4"	1 Set/Box
45991	"Brooklyn"	70644B	4"	1 Set/Box
45990	"Dallas"	70622B	4"	1 Set/Box
45987	"Daytona"	70601B	4"	1 Set/Box
45989	"Talladega"	70621B	4"	1 Set/Box
45988	"Vegas"	70602B	4"	1 Set/Box



### Chrome Air Valve Lever Adapter

DESCRIPTION

- Chrome Air Horn Valve Lever Adapter
- For Fitting Design Grip onto United Pacific Air Horn Valve Levers

Item #	Description	Package	Pack
46105B	Air Valve Lever Adapter	Boxed	1 Pc./Box



### Wood Center Console

DESCRIPTION

- Hand-Crafted Wood Center Console for Peterbilt
- Available with or without Cup Holder

Item #	Description	Package	Pack
88201	With Cup Holder	Boxed	1 Pc./Box
88200	Without Cup Holder	Boxed	1 Pc./Box



# INTERIOR DOOR ACCESSORIES

Mirror Switch Trim  
Pg. 87

Speaker Cover  
Pg. 88

Door Handle Insert  
Pg. 89

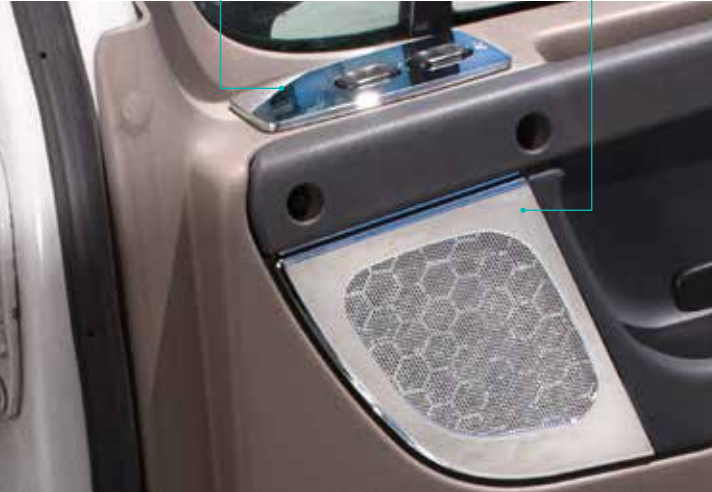

Bolt/Nut Covers  
Pg. 92

Door Speaker  
Pg. 88

Window Trim  
Pg. 89

Window Cranks  
Pg. 89

**Freightliner Armrest Cover**

DESCRIPTION

- Chrome Plastic Armrest Cover for Freightliner
- Fits Freightliner Century, Coronado & Columbia
- Available in Pairs or Individually

Item #	Description	Package	Pack
<b>41942</b>	Driver Cover	Carded	1 Pc./Card
<b>41943</b>	Passenger Cover	Carded	1 Pc./Card
<b>41944</b>	Cover Set	Pair	1 Pair/Card



Also available in a set, Item # 41944 (41942 + 41943)

**Freightliner Window Switch Panel**

DESCRIPTION

- Chrome Plastic Window Switch Panel for Freightliner
- Fits Freightliner Century, Coronado & Columbia

Item #	Side	Openings	Package	Pack
<b>41959</b>	Driver	3	Carded	1 Pc./Card
<b>41975</b>	Driver	2	Carded	1 Pc./Card
<b>41976</b>	Driver	1	Carded	1 Pc./Card
<b>41960</b>	Passenger	1	Carded	1 Pc./Card



**Freightliner Cascadia Window Switch Panel**

DESCRIPTION

- Chrome Plastic Window Switch Panel for Freightliner
- Fits 2007+ Freightliner Cascadia

Item #	Side	Openings	Package	Pack
<b>42097</b>	Driver	5	Carded	1 Pc./Card
<b>42095</b>	Passenger	2	Carded	1 Pc./Card



**Freightliner Mirror Switch Trim**

DESCRIPTION

- Chrome Plastic Mirror Switch Trim
- Fits Newer Freightliner Century, Coronado & Columbia

Item #	Description	Package	Pack
<b>41114</b>	Mirror Switch Trim	Carded	1 Pc./Card



**Rocker Switch Trim - Double**

DESCRIPTION

- Chrome Plastic Rocker Switch Trim with Two Openings
- Designed for Freightliner Window Switch Panel

Item #	Description	Package	Pack
<b>41913</b>	Double Switch Trim	Carded	1 Pc./Card



**Rocker Switch Trim - Diamond**

## DESCRIPTION

- Chrome Plastic Rocker Switch Cover with Chrystal Diamond
- Fits Various Models, Available with or without Diamond

Item #	Style	Jewel Color	Package	Pack
<b>41142</b>	Diamond	Blue	Carded	3 Pcs./Card
<b>41143</b>	Diamond	Clear	Carded	3 Pcs./Card
<b>41144</b>	Diamond	Green	Carded	3 Pcs./Card
<b>41145</b>	Diamond	Purple	Carded	3 Pcs./Card
<b>41146</b>	Diamond	Red	Carded	3 Pcs./Card
<b>41140</b>	Indented	-	Carded	3 Pcs./Card

**Freightliner Stainless Window Sill Cover**

## DESCRIPTION

- Stainless Steel Window Sill Cover for Freightliner
- Fits Classic and FLD, Sold in Pairs Only

Item #	Description	Package	Pack
<b>21727</b>	Stainless Window Sill	Carded	1 Pair/Card

**Freightliner Door Handle Insert**

## DESCRIPTION

- Chrome Plastic Door Handle Insert for Freightliner
- Fits Freightliner Classic and FLD

Item #	Description	Package	Pack
<b>20600</b>	Chrome Handle Insert	Carded	2 Pcs./Card

**2007+ Freightliner Cascadia Door Speaker Cover**

## DESCRIPTION

- Chrome Plastic Door Speaker Cover for 2007+ Freightliner Cascadia
- Driver or Passenger Door Speaker Cover Available Separately

Item #	Description	Package	Pack
<b>42084</b>	Speaker Cover - Driver	Carded	1 Pc./Card
<b>42085</b>	Speaker Cover - Passenger	Carded	1 Pc./Card

**Freightliner Door Speaker Grill**

## DESCRIPTION

- Chrome Freightliner Door Speaker Grill
- Fits Freightliner Century, Coronado & Columbia

Item #	Description	Package	Pack
<b>40880</b>	Rectangle Door Speaker Grill	Carded	1 Pc./Card
<b>40881</b>	Driver Speaker Grill	Carded	1 Pc./Card
<b>40882</b>	Passenger Speaker Grill	Carded	1 Pc./Card



40881 - Driver Side



40882 - Passenger Side

### 2007+ Freightliner Cascadia Door Handle Cover

**DESCRIPTION**

- Chrome Plastic Door Handle Cover for 2007+ Freightliner Cascadia
- Also Fits Some Freightliner Coronados
- Driver and Passenger Side Available Separately

Item #	Description	Package	Pack
<b>42098</b>	Handle Cover - Driver	Carded	1 Set/Card
<b>42099</b>	Handle Cover - Passenger	Carded	1 Set/Card



### Freightliner Cascadia Interior Door Handle

**DESCRIPTION**

- Chrome or Black Freightliner Cascadia Interior Door Handle
- Driver and Passenger Side Available Separately

Item #	Application	Finish	Package	Pack
<b>42384</b>	Driver	Black	Carded	1 Pc./Card
<b>42385</b>	Passenger	Black	Carded	1 Pc./Card
<b>42386</b>	Driver	Chrome	Carded	1 Pc./Card
<b>42387</b>	Passenger	Chrome	Carded	1 Pc./Card



### Freightliner Interior View Window Trim

**DESCRIPTION**

- Freightliner Interior View Window Trim

Item #	Description	Package	Pack
<b>48111</b>	Chrome Window Trim	Carded	1 Pc./Card



### Freightliner Window Crank - Diamond

**DESCRIPTION**

- Chrome Plastic Window Crank with Crystal Diamond
- Fits Freightliner Classic and FLD, Metal Slot Insert

Item #	Style	Jewel Color	Package	Pack
<b>24031</b>	Diamond	Amber	Carded	1 Pc./Card
<b>24032</b>	Diamond	Blue	Carded	1 Pc./Card
<b>24033</b>	Diamond	Clear	Carded	1 Pc./Card
<b>24034</b>	Diamond	Green	Carded	1 Pc./Card
<b>24035</b>	Diamond	Purple	Carded	1 Pc./Card
<b>24036</b>	Diamond	Red	Carded	1 Pc./Card
<b>24001</b>	Plain	-	Carded	1 Pc./Card



**Chrome Window Crank**

DESCRIPTION

- Chrome Window Crank for Peterbilt
- Available with Slot or Square Adapter

Item #	Description	Package	Pack
<b>24021</b>	Slot Adapter	Carded	1 Kit/Card
<b>24028</b>	Square Adapter	Carded	1 Kit/Card



**Chrome Window Crank - Diamond**

DESCRIPTION

- Chrome Window Crank with Crystal Diamond for Kenworth
- Available with Slot or Square Adapter

**Chrome Window Crank with Diamond - Slot Adapter**

Item #	Style	Jewel Color	Package	Pack
<b>24015</b>	Diamond	Amber	Carded	1 Pc./Card
<b>24016</b>	Diamond	Blue	Carded	1 Pc./Card
<b>24017</b>	Diamond	Clear	Carded	1 Pc./Card
<b>24018</b>	Diamond	Green	Carded	1 Pc./Card
<b>24019</b>	Diamond	Purple	Carded	1 Pc./Card
<b>24020</b>	Diamond	Red	Carded	1 Pc./Card

**Chrome Window Crank with Diamond - Square Adapter**

Item #	Style	Jewel Color	Package	Pack
<b>24022</b>	Diamond	Amber	Carded	1 Pc./Card
<b>24023</b>	Diamond	Blue	Carded	1 Pc./Card
<b>24024</b>	Diamond	Clear	Carded	1 Pc./Card
<b>24025</b>	Diamond	Green	Carded	1 Pc./Card
<b>24026</b>	Diamond	Purple	Carded	1 Pc./Card
<b>24027</b>	Diamond	Red	Carded	1 Pc./Card



**Window Crank Base**

DESCRIPTION

- Window Crank Base for Kenworth
- Deluxe Kit Includes: 1 Deluxe Chrome Base and 1 Spring

Item #	Description	Package	Pack
<b>24010</b>	Deluxe Kit	Carded	1 Kit/Card



**Window Crank Screw**

DESCRIPTION

- Chrome Window Crank Screw, Threaded Stem= 7/16" Long
- Fits Most Trucks, May not Fit Cranks with Slot Adapter
- Perfect Complement to United Pacific's Chrome Window Cranks

Item #	Thread	Stem	Package	Pack
<b>24011</b>	0.9 G	7/16"	Carded	1 Pc./Card



**Billet Window Crank Kit**

DESCRIPTION

- Billet Aluminum Window Crank Kit
- Perfect for Cars, SUVs, Pick-Ups & Trucks
- Universal Application, 3 Adapters Included (Circular, Slotted, & Square)

Item #	Description	Package	Pack
<b>24009</b>	Billet Window Crank Kit	Carded	1 Pc./Card



**Billet Style Door Handle Kit**

**DESCRIPTION**

- Billet Aluminum Door Handle Kit
- Universal Application, Perfect for Cars, SUVs, Pick-Ups, and Trucks
- 3 Adapters Included: Circular, Slotted, and Square

Item #	Description	Package	Pack
<b>24039</b>	Billet Universal Handle Kit	Carded	1 Pair/Card



**Chrome Grab Handle - Nude Lady**

**DESCRIPTION**

- Universal Application, 12 1/4" Chrome Nude Lady Grab Handle

Item #	Description	Package	Pack
<b>C5036-3</b>	Chrome Nude Lady	Boxed	1 Pc./Box



**Chrome Grab Handle**

**DESCRIPTION**

- Chrome Grab Handle, Universal Application
- Available in a Kit or a Handle Only
- Kit Includes: 1 Chrome Grab Handle, 2 Rubber Gaskets, and 4 Chrome Screws

Item #	Description	Package	Pack
<b>10960</b>	Grab Handle Kit	Carded	1 Kit/Card
<b>10958</b>	Grab Handle Only	Bulk	1 Pc.



**Freightliner Wood Armrest Trim**

**DESCRIPTION**

- Handcrafted Wood Armrest Trim for Freightliner
- Fits Freightliner Classic and FLD
- Sold in 4 Pieces Set Only

Item #	Description	Package	Pack
<b>88208</b>	Armrest Trim	Set	4 Pcs./Set



**Accent Strips**

**DESCRIPTION**

- Accent Strips in Wood or Chrome Aluminum
- Universal Application, Double Side Tape Mount

Item #	Material	Size	Package	Pack
<b>88004</b>	Wood	21 3/8" x 1 1/2"	Bulk	1 Pc.
<b>21527</b>	Aluminum	11 1/4" x 1 1/2"	Carded	1 Pc./Card

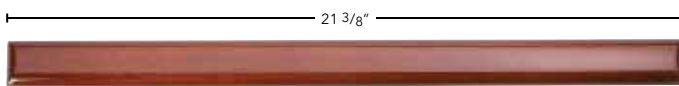

24008



21527

**Wood Door Pocket**

**DESCRIPTION**

- Hand Crafted Wood Door Pocket
- Universal Application

Item #	Description	Package	Pack
<b>88088</b>	Wood Door Pocket	Boxed	1 Pc./Box



**Skull Snap Cap**

## DESCRIPTION

- Chrome Plastic Skull Snap Cap
- Fits Various Screw Head Sizes

Item #	Description	Package	Pack
<b>70196</b>	Fits Size 10/12 Screw Head	Carded	10 Pcs./Card
<b>70197</b>	Fits Size 14 Screw Head	Carded	10 Pcs./Card

**Chrome Spike Snap-On Covers**

## DESCRIPTION

- Chrome Plastic Spike Snap-On Covers
- Only Fits Size 10/12 Screw

Item #	Description	Package	Pack
<b>70084</b>	Fits Size 10/12 Screw	Carded	4 Pcs./Card

**Chrome Snap Cap**

## DESCRIPTION

- Chrome Plastic Snap Cap
- Fits Various Screw Head Sizes

Item #	Description	Package	Pack
<b>70086</b>	Fits Size 6/8 Screw Head	Carded	10 Pcs./Card
<b>70088</b>	Fits Size 10/12 Screw Head	Carded	10 Pcs./Card
<b>70251</b>	Fits Size 14 Screw Head	Carded	10 Pcs./Card

**Chrome Door Lock - Diamond**

## DESCRIPTION

- Chrome Aluminum Door Lock with Crystal Diamond
- Available in 2 sizes: 7/16" Medium Diamond and 9/16" Large Diamond

**Medium Diamond Door Lock - 7/16" Diamond**

Item #	Style	Jewel Color	Package	Pack
<b>40199</b>	Diamond	Amber	Carded	2 Pcs./Card
<b>40200</b>	Diamond	Blue	Carded	2 Pcs./Card
<b>40201</b>	Diamond	Clear	Carded	2 Pcs./Card
<b>40202</b>	Diamond	Green	Carded	2 Pcs./Card
<b>40204</b>	Diamond	Purple	Carded	2 Pcs./Card
<b>40205</b>	Diamond	Red	Carded	2 Pcs./Card
<b>40180</b>	Pointed	-	Carded	2 Pcs./Card

**Large Diamond Door Lock - 9/16" Diamond**

Item #	Style	Jewel Color	Package	Pack
<b>70210</b>	Diamond	Amber	Carded	2 Pcs./Card
<b>70211</b>	Diamond	Blue	Carded	2 Pcs./Card
<b>70212</b>	Diamond	Clear	Carded	2 Pcs./Card
<b>70213</b>	Diamond	Green	Carded	2 Pcs./Card
<b>70214</b>	Diamond	Purple	Carded	2 Pcs./Card
<b>70215</b>	Diamond	Red	Carded	2 Pcs./Card
<b>70209</b>	Pointed	-	Carded	2 Pcs./Card



Medium Knob

Pointed

Large Knob

**Dice Door Lock Knobs**

## DESCRIPTION

- Dice Door Lock Knobs, Available in 7 Different Colors

Item #	Dice Style	Pack
<b>70042</b>	Black Dice	2 Pcs./Card
<b>70043</b>	Blue Dice	2 Pcs./Card
<b>70151</b>	Purple Dice	2 Pcs./Card
<b>70040</b>	Red Dice	2 Pcs./Card
<b>70041</b>	White Dice	2 Pcs./Card
<b>70049</b>	Chrome Dice	2 Pcs./Card





**8 Ball Door Lock Knobs**

Item #	Description	Pack
<b>70023</b>	8 Ball	2 Pcs./Card



**Maltese Cross Door Lock Knobs**

Item #	Description	Pack
<b>70095</b>	Iron Cross	2 Pcs./Card

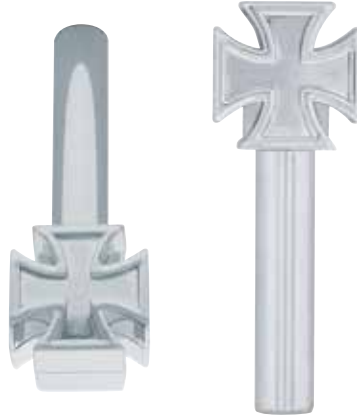

**Skull Door Lock Knobs**

Item #	Description	Pack
<b>70029</b>	Skull	2 Pcs./Card



**Piston Door Lock Knobs**

Item #	Description	Pack
<b>70035</b>	Chrome Piston	2 Pcs./Card



**Chrome Metal Tube Door Lock Knobs**

Item #	Description	Pack
<b>70044</b>	Tube	2 Pcs./Card



**Chrome Bullet Door Lock Knobs**

Item #	Description	Pack
<b>70048</b>	Bullet	2 Pcs./Card



**Chrome/Walnut Tube Door Lock Knobs**

Item #	Description	Pack
<b>70039</b>	Tube	2 Pcs./Card



**Popular Item!**

**Axle Cover Combo Kit - 33mm**

**DESCRIPTION**

- Chrome Plastic Axle Cover Combo Kit
- Includes Everything You Need to Dress Up Your Wheels

Item #	Nut Size	Style	Package	Pack
<b>10305</b>	33 mm Thread-On	Dome	Color Box	1 Kit./Box

**- Kit Includes:**

- Chrome Plastic 33mm Thread-On Nut Cover x 60
- Chrome Plastic Front Axle Cover x 2
- Chrome Plastic Rear Axle Cover x 4
- Nut Cover Tool x 1



# UPPER CAB/SLEEPER ACCESSORIES



Upper Storage Trim  
Pg. 95

Storage Door Cover  
Pg. 95



C.B. Trim  
Pg. 95

Speaker Cover/Grill  
Pg. 97

Vinyl Bolt Covers  
Pg. 97



Map Light  
Pg. 99

Window Post  
Pg. 96

Radio Face Plate  
Pg. 95

**2007+ Freightliner Cascadia Upper Storage Trim**

DESCRIPTION

- Chrome Plastic Upper Storage Pocket Trim for 2007+ FL Cascadia

Item #	Description	Package	Pack
<b>42310</b>	Upper Storage Trim	Carded	1 Pc./Card



**Freightliner Upper Storage Trim**

DESCRIPTION

- Chrome Plastic Upper C.B. and Storage Trim for Freightliner  
- Fits Freightliner Century and Various Other Models

Item #	Description	Package	Pack
<b>41909</b>	Storage Trim	Carded	1 Pc./Card
<b>41910</b>	C.B. Trim	Carded	1 Pc./Card



**2007+ Freightliner Cascadia C.B. Trim**

DESCRIPTION

- Chrome Plastic Upper C.B. Trim for 2007+ Freightliner Cascadia  
- C.B. Bracket Holes are Approximately 4 3/4" Apart

Item #	Description	Package	Pack
<b>42329</b>	Upper C.B. Trim	Carded	1 Pc./Card



**Freightliner Century Overhead Door Cover**

DESCRIPTION

- Stainless Steel Freightliner Century Overhead Door Cover

Item #	Description	Package	Pack
<b>41906</b>	Overhead Door Cover	Carded	1 Pc./Card



**Chrome Freightliner Cascadia Storage Door Cover**

DESCRIPTION

- Chrome Plastic Storage Door Cover for Freightliner Cascadia  
- Easy Installation, Double Sided Tape Included

Item #	Description	Fits	Pack
<b>42343</b>	13 1/2" Upper Center Cover	T155, 415277	1 Pc./Card
<b>42344</b>	12 3/4" Upper L or R Cover	T155, 415278	1 Pc./Card



**Freightliner Stainless Steel Radio Face Plate - Cobra 29**

DESCRIPTION

- Stainless Steel Radio Face Plate for Cobra 29

Item #	Description	Package	Pack
<b>21909</b>	SS Radio Face Plate	Skin Packed	1 Pc./Pack



**Freightliner Side Window Post**

DESCRIPTION

- Freightliner Side Window Post for Freightliner Classic and FLD
- Chrome Plastic Window Post (Item # 28133) replaces the OEM Window Post
- Stainless Steel Window Post (Item # 28134) covers the OEM Window Post
- Sold in Pairs Only

Item #	Description	Package	Pack
<b>28133</b>	Chrome Window Post	Carded	1 Pair/Card
<b>28134</b>	Stainless Window Post Cover	Carded	1 Pair/Card



**Freightliner Stainless Center Window Post Cover**

DESCRIPTION

- Stainless Steel Center Window Post Cover for Freightliner
- Double Sided Tape on Back

Item #	Description	Package	Pack
<b>28135</b>	Center Window Post	Carded	1 Pc./Pack



**Chrome Clock Bezel - Diamond**

DESCRIPTION

- Chrome Plastic Clock Bezel with Crystal Diamond
- Available with or without Diamond, Available with or without Visor
- Fits Freightliner Century, Coronado, & Columbia
- Fits 2 7/16" Dia. Clock

**Freightliner Clock Bezel with Visor**

Item #	Style	Jewel Color	Package	Pack
<b>41925</b>	Diamond	Blue	Carded	1 Pc./Card
<b>41926</b>	Diamond	Clear	Carded	1 Pc./Card
<b>41927</b>	Diamond	Green	Carded	1 Pc./Card
<b>41928</b>	Diamond	Purple	Carded	1 Pc./Card
<b>41929</b>	Diamond	Red	Carded	1 Pc./Card
<b>41923</b>	Indented	-	Carded	1 Pc./Card
<b>41922</b>	Plain	-	Carded	1 Pc./Card

**Freightliner Clock Bezel without Visor**

Item #	Style	Jewel Color	Package	Pack
<b>41933</b>	Diamond	Blue	Carded	1 Pc./Card
<b>41934</b>	Diamond	Clear	Carded	1 Pc./Card
<b>41935</b>	Diamond	Green	Carded	1 Pc./Card
<b>41936</b>	Diamond	Purple	Carded	1 Pc./Card
<b>41937</b>	Diamond	Red	Carded	1 Pc./Card
<b>41931</b>	Indented	-	Carded	1 Pc./Card
<b>41930</b>	Plain	-	Carded	1 Pc./Card



### Freightliner Speaker Cover/Grill

DESCRIPTION

- Chrome Speaker Cover and Grill for Freightliner
- Fits Various Models and Years

Item #	Description	Package	Pack
<b>40914</b>	Sleeper Speaker Grill	Carded	2 Pcs./Card



### Freightliner Sleeper Vent Trim

DESCRIPTION

- Chrome Plastic Sleeper Vent Trim for Freightliner
- Fits Various Freightliner Models and Years

Item #	Description	Package	Pack
<b>42083</b>	Sleeper Vent Trim	Carded	1 Pc./Card



### Freightliner Upper Bunk Handle

DESCRIPTION

- Chrome Plastic Upper Bunk Release Handle for Freightliner
- Fits Various Freightliner Models and Years, Hex Screw Mount

Item #	Description	Package	Pack
<b>42063</b>	Upper Bunk Handle	Carded	1 Pc./Card



### 2006+ Freightliner Dome Light Cover

DESCRIPTION

- Chrome Plastic Dome Light Cover for 2006+ Freightliner
- Sold in Carded Only

Item #	Description	Package	Pack
<b>41998</b>	Dome Light Cover	Carded	1 Pc./Card

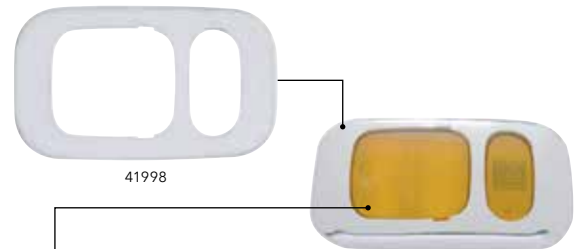

### Freightliner Vinyl Button Cover

DESCRIPTION

- Chrome Plastic Vinyl Button Cover
- Fits Various Freightliner Models

Item #	Description	Package	Pack
<b>70195</b>	Vinyl Button Cover	Carded	10 Pcs./Pack
<b>70195B</b>	Vinyl Button Cover	Bulk	1 Pc.



### 2006+ Freightliner Dome Light Cover

DESCRIPTION

- Dome Light Lens for 2006+ Freightliner
- Direct Replacement of the OEM Dome Light Lens
- Sold: Carded = 1 Set, 2 Pieces Per Set

Item #	Description	Package	Pack
<b>41983</b>	Amber	Carded	1 Pc./Card
<b>41984</b>	Blue	Carded	1 Pc./Card
<b>41985</b>	Clear	Carded	1 Pc./Card
<b>41986</b>	Green	Carded	1 Pc./Card
<b>41987</b>	Purple	Carded	1 Pc./Card
<b>41988</b>	Red	Carded	1 Pc./Card

**Dome Light Lens**

## DESCRIPTION

- Replacement Dome Light Lens for Freightliner
- Rectangular Dome Light Lens - 2 1/16" × 2 7/8"
- Rectangular Dome Light Lens - 2 1/16" × 2 7/8"
- Rectangular Dome Light Lens - 2 1/4" × 3 1/4"
- Square Dome Lens 3" × 3"

**Rectangular Dome Light Lens (2 1/16" × 2 7/8")**

Item #	Description	Package	Pack
<b>30827</b>	Green	Carded	1 Pc./Card
<b>30825</b>	Purple	Carded	1 Pc./Card
<b>30826</b>	Red	Carded	1 Pc./Card

**Rectangular Dome Light Lens (2 1/16" × 2 7/8")**

Item #	Description	Package	Pack
<b>30822</b>	Amber	Carded	1 Pc./Card
<b>30818</b>	Blue	Carded	1 Pc./Card
<b>30821</b>	Green	Carded	1 Pc./Card
<b>30819</b>	Purple	Carded	1 Pc./Card
<b>30820</b>	Red	Carded	1 Pc./Card

**Rectangular Dome Light Lens (2 1/4" × 3 1/4")**

Item #	Description	Package	Pack
<b>30852</b>	Amber	Carded	1 Pc./Card
<b>30853</b>	Blue	Carded	1 Pc./Card
<b>30854</b>	Green	Carded	1 Pc./Card
<b>30855</b>	Purple	Carded	1 Pc./Card
<b>30856</b>	Red	Carded	1 Pc./Card

**Square Dome Light Lens (3" × 3")**

Item #	Description	Package	Pack
<b>30830</b>	Blue	Carded	1 Pc./Card
<b>30833</b>	Green	Carded	1 Pc./Card

**Chrome Round Swivel Dome/Map Light Base**

## DESCRIPTION

- Chrome Plastic Swivel Dome/Map Light Base
- Base Only, Lens Sold Separately

Item #	Description	Package	Pack
<b>30835</b>	Dome Light Base	Carded	1 Pc./Card



Peterbilt 370 Series (2 1/16" × 2 7/8")



Peterbilt 350 Series (2 1/16" × 2 7/8")



Rectangular (2 1/4" × 3 1/4")



Square (3" × 3")



### Round Dome/Map Light Lens

**DESCRIPTION**

- Replacement Dome/Map Light Lens, Fits Most Interior Dome/Map Light
- Proper Installation May Require the Use of Conversion Grommets, Available Separately
- Lens Available in Glass or Plastic
- Glass Flat Lens: Approximately 1 11/16" Diameter
- Plastic Dome Lens: Approximately 1 3/8" Diameter

#### Glass Flat Lens - 1 11/16" Dia.

Item #	Description	Package	Pack
<b>30841</b>	Amber	Carded	1 Pc./Card
<b>30843</b>	Green	Carded	1 Pc./Card
<b>30844</b>	Purple	Carded	1 Pc./Card

#### Plastic Dome Lens - 1 3/8" Dia.

Item #	Description	Package	Pack
<b>30805</b>	Amber	Carded	1 Pc./Card
<b>30806</b>	Blue	Carded	1 Pc./Card
<b>30808</b>	Purple	Carded	1 Pc./Card
<b>30809</b>	Red	Carded	1 Pc./Card

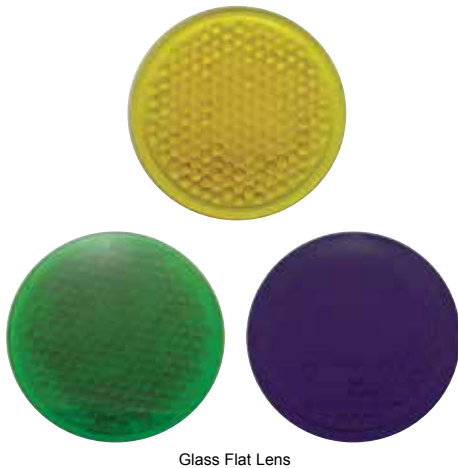

Glass Flat Lens



Plastic Dome Lens

### Dome/Map Light Conversion Grommet

**DESCRIPTION**

- Conversion Grommet is Used Between the Dome/Map Light Bezel and United Pacific Glass or Plastic Replacement Lens
- Grommet Required on Some Installations

Item #	Description	Package	Pack
<b>30837</b>	Dome/Map Grommet	Carded	1 Pc./Card
<b>30839</b>	Glass Lens Grommet	Carded	1 Pc./Card



30837



30839

### Chrome Spot Light Trim

**DESCRIPTION**

- Chrome Plastic Spot Light Trim, Universal Application
- Available Carded

Item #	Description	Package	Pack
<b>40851</b>	Spot Light Trim	Carded	2 Pcs./Card



### Wood Dome/Map Light Trim

**DESCRIPTION**

- Handcrafted Wood Dome/Map Light Trim
- Available in 5 Piece Set Only

Item #	Description	Package	Pack
<b>88207</b>	Wood Dome/Map Trim	Boxed	5 Pcs./Box

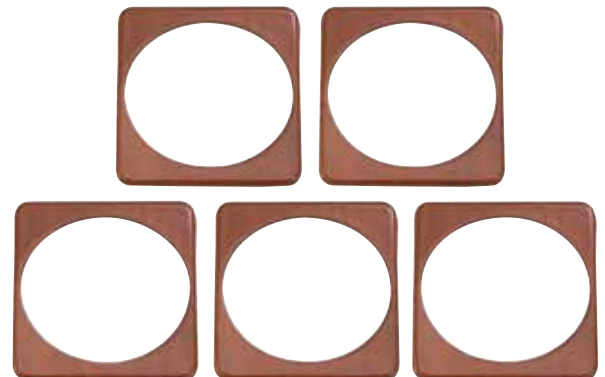

# C.B. ACCESSORIES

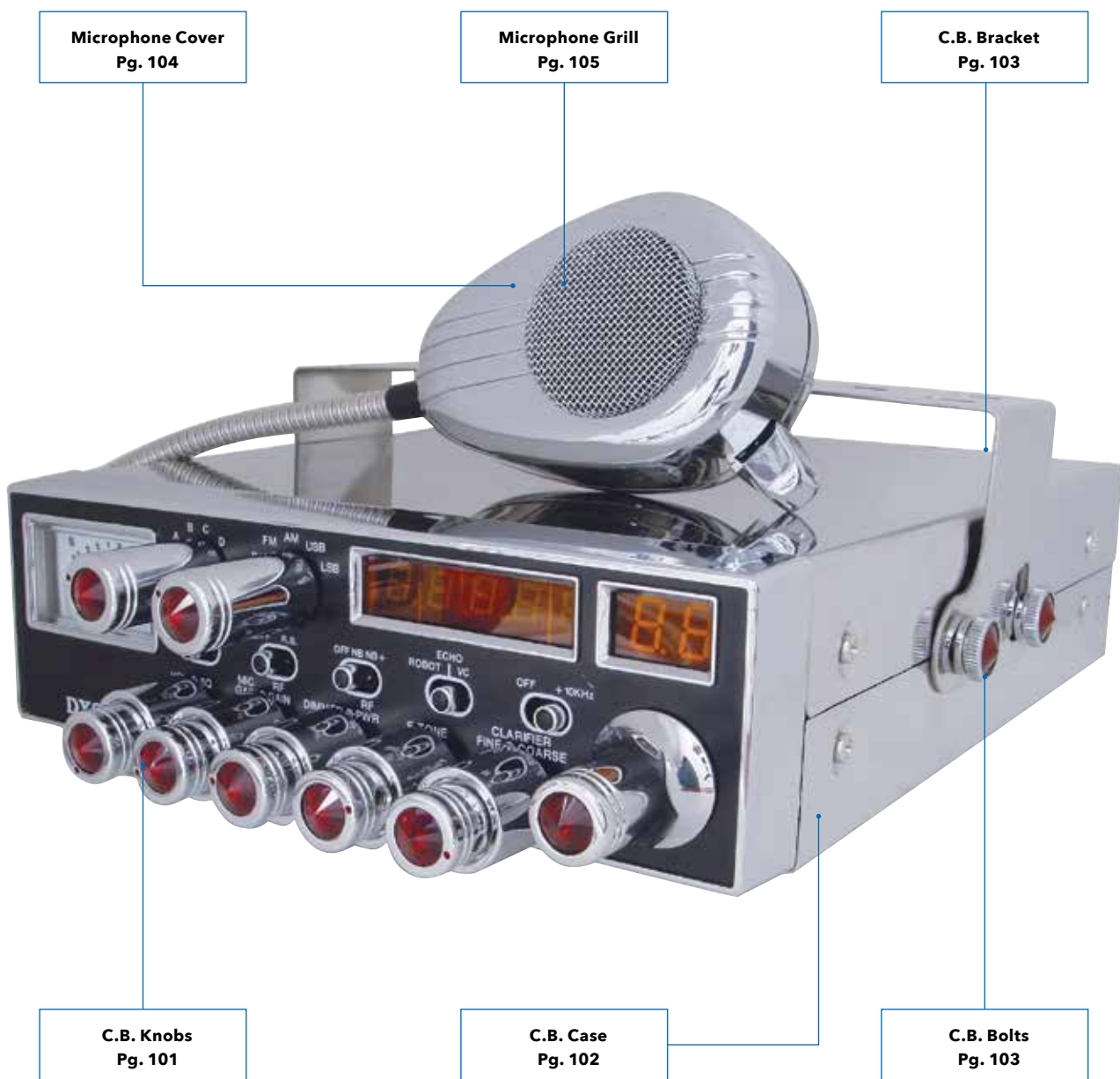





### Chrome C.B. Knob

#### DESCRIPTION

- Chrome Aluminum C.B. Knob
- Available with or without Crystal Diamonds

Item #	Style	Jewel Color	Package	Pack
<b>21771</b>	Diamond	Amber	Carded	2 Pcs./Card
<b>21771B</b>	Diamond	Amber	Bulk	1 Pc.
<b>21772</b>	Diamond	Blue	Carded	2 Pcs./Card
<b>21772B</b>	Diamond	Blue	Bulk	1 Pc.
<b>21773</b>	Diamond	Clear	Carded	2 Pcs./Card
<b>21773B</b>	Diamond	Clear	Bulk	1 Pc.
<b>21774</b>	Diamond	Green	Carded	2 Pcs./Card
<b>21774B</b>	Diamond	Green	Bulk	1 Pc.
<b>21775</b>	Diamond	Purple	Carded	2 Pcs./Card
<b>21775B</b>	Diamond	Purple	Bulk	1 Pc.
<b>21776</b>	Diamond	Red	Carded	2 Pcs./Card
<b>21776B</b>	Diamond	Red	Bulk	1 Pc.
<b>21777</b>	Pointed	-	Carded	2 Pcs./Card
<b>21777B</b>	Pointed	-	Bulk	1 Pc.



### Chrome C.B. Channel Knob

#### DESCRIPTION

- Chrome Aluminum C.B. Channel Knob
- Available with or without Crystal Diamonds

Item #	Style	Jewel Color	Package	Pack
<b>21778</b>	Diamond	Amber	Carded	1 Pc./Card
<b>21778B</b>	Diamond	Amber	Bulk	1 Pc.
<b>21779</b>	Diamond	Blue	Carded	1 Pc./Card
<b>21779B</b>	Diamond	Blue	Bulk	1 Pc.
<b>21780</b>	Diamond	Clear	Carded	1 Pc./Card
<b>21780B</b>	Diamond	Clear	Bulk	1 Pc.
<b>21781</b>	Diamond	Green	Carded	1 Pc./Card
<b>21781B</b>	Diamond	Green	Bulk	1 Pc.
<b>21782</b>	Diamond	Purple	Carded	1 Pc./Card
<b>21782B</b>	Diamond	Purple	Bulk	1 Pc.
<b>21783</b>	Diamond	Red	Carded	1 Pc./Card
<b>21783B</b>	Diamond	Red	Bulk	1 Pc.
<b>21784</b>	Pointed	-	Carded	1 Pc./Card
<b>21784B</b>	Pointed	-	Bulk	1 Pc.



### Chrome C.B. On/Off/Volume/Squelch Knob

#### DESCRIPTION

- Chrome Aluminum C.B. On/Off/Volume/Squelch Knob
- Available with or without Crystal Diamonds

Item #	Style	Jewel Color	Package	Pack
<b>21785</b>	Diamond	Amber	Carded	1 Pc./Card
<b>21785B</b>	Diamond	Amber	Bulk	1 Pc.
<b>21786</b>	Diamond	Blue	Carded	1 Pc./Card
<b>21786B</b>	Diamond	Blue	Bulk	1 Pc.
<b>21787</b>	Diamond	Clear	Carded	1 Pc./Card
<b>21788</b>	Diamond	Clear	Bulk	1 Pc.
<b>21788B</b>	Diamond	Green	Carded	1 Pc./Card
<b>21789</b>	Diamond	Green	Bulk	1 Pc.
<b>21789B</b>	Diamond	Purple	Carded	1 Pc./Card
<b>21790</b>	Diamond	Purple	Bulk	1 Pc.
<b>21790B</b>	Diamond	Red	Carded	1 Pc./Card
<b>21791</b>	Diamond	Red	Bulk	1 Pc.
<b>21791B</b>	Pointed	-	Carded	1 Pc./Card
<b>21784B</b>	Pointed	-	Bulk	1 Pc.

**C.B. Case - Stainless Steel**

DESCRIPTION

- Stainless Steel C.B. Case
- Available for Various C.B. Brands
- Sold Skin Packed, 1 Set/Skin Pack

Item #	C.B. Brand	Mic. Output	Speaker Hole
<b>21701</b>	Cobra 29, Uniden 76/78	Front	Yes
<b>21702</b>	Cobra 29, Uniden 76, Grant	Front	No
<b>21703</b>	Cobra 29, Uniden 76, Grant	Side	No
<b>21704</b>	Cobra 148, Galaxy, Conex	Front	No
<b>21705</b>	Cobra 148, Galaxy, Conex	Side	Yes
<b>21713</b>	Cobra 29, Uniden 66/68	Front	Yes



**C.B. Case - Wood**

DESCRIPTION

- Wood C.B. Case, No Speaker Hole
- Available for Various C.B. Brands, Stainless C.B. Bracket Included
- Sold Boxed, 1 Set/Box

Item #	C.B. Brand	Mic. Output	Interior Dim.
<b>88063</b>	Cobra 29, Uniden 76, Grant	Side	7 1/2" x 2 3/8"
<b>88065</b>	Cobra 148, Galaxy, Conex	Front	8 1/8" x 2 1/2"



**C.B. Mounting Bolt**

DESCRIPTION

- Stainless Steel C.B. Mounting Bolt
- Available in Various Sizes

**4 mm C.B. Mounting Bolt**



4 mm C.B. Mounting Bolt

Item #	Style	Jewel Color	Package	Pack
<b>21751</b>	Diamond	Amber	Carded	2 Pcs./Card
<b>21752</b>	Diamond	Blue	Carded	2 Pcs./Card
<b>21753</b>	Diamond	Clear	Carded	2 Pcs./Card
<b>21754</b>	Diamond	Green	Carded	2 Pcs./Card
<b>21755</b>	Diamond	Purple	Carded	2 Pcs./Card
<b>21756</b>	Diamond	Red	Carded	2 Pcs./Card
<b>21691</b>	Plain - Slot	-	Carded	2 Pcs./Card
<b>21691B</b>	Plain - Slot	-	Bulk	1 Pc.

**5 mm C.B. Mounting Bolt**



5 mm C.B. Mounting Bolt

Item #	Style	Jewel Color	Package	Pack
<b>21758</b>	Diamond	Amber	Carded	2 Pcs./Card
<b>21758B</b>	Diamond	Amber	Bulk	1 Pc.
<b>21759</b>	Diamond	Blue	Carded	2 Pcs./Card
<b>21760</b>	Diamond	Clear	Carded	2 Pcs./Card
<b>21761</b>	Diamond	Green	Carded	2 Pcs./Card
<b>21762</b>	Diamond	Purple	Carded	2 Pcs./Card
<b>21762B</b>	Diamond	Purple	Bulk	1 Pc.
<b>21763</b>	Diamond	Red	Carded	2 Pcs./Card
<b>21763B</b>	Diamond	Red	Bulk	1 Pc.
<b>21692</b>	Plain - Slot	-	Carded	2 Pcs./Card
<b>21692B</b>	Plain - Slot	-	Bulk	1 Pc.

**6 mm C.B. Mounting Bolt**



6 mm C.B. Mounting Bolt

Item #	Style	Jewel Color	Package	Pack
<b>21765</b>	Diamond	Amber	Carded	2 Pcs./Card
<b>21765B</b>	Diamond	Amber	Bulk	1 Pc.
<b>21766</b>	Diamond	Blue	Carded	2 Pcs./Card
<b>21767</b>	Diamond	Clear	Carded	2 Pcs./Card
<b>21768</b>	Diamond	Green	Carded	2 Pcs./Card
<b>21769</b>	Diamond	Purple	Carded	2 Pcs./Card
<b>21769B</b>	Diamond	Purple	Bulk	1 Pc.
<b>21770</b>	Diamond	Red	Carded	2 Pcs./Card
<b>21693</b>	Plain - Slot	-	Carded	2 Pcs./Card
<b>21693B</b>	Plain - Slot	-	Bulk	1 Pc.

**C.B. Bracket - Stainless Steel**

DESCRIPTION

- Stainless Steel C.B. Bracket
- Fits Various C.B. Brands



Item #	Application	Length	Package
<b>21706</b>	Cobra C.B. Case	7 3/8"	Bulk = 1 Pc.
<b>21707</b>	Galaxy C.B. Case	8"	Bulk = 1 Pc.

**Chrome C.B. Enclosure**

DESCRIPTION

- Chrome Plastic C.B. Enclosure
- Fits Various Years and Models

Item #	Description	Package	Pack
<b>41189</b>	C.B. Enclosure	Carded	1 Pc./Card



**2007+ Freightliner Cascadia C.B. Trim**

DESCRIPTION

- Chrome Plastic Upper C.B. Trim for 2007+ Freightliner Cascadia
- Bracket Holes are Approximately 4 3/4" Apart

Item #	Description	Package	Pack
<b>42329</b>	C.B. Radio Trim	Carded	1 Pc./Card



**Signature C.B. Microphone Cover - Diamond**

DESCRIPTION

- Chrome Plastic C.B. Microphone Cover with Crystal Diamond
- Replaces Existing Road King 56 C.B. Microphone Cover
- Stainless Steel C.B. Grill Included, Colored Grills Available Separately
- Available with Visor and 6 Different Color Diamonds

Item #	Style	Jewel Color	Package	Pack
<b>41203</b>	Diamond	Amber	Carded	1 Pc./Card
<b>41204</b>	Diamond	Blue	Carded	1 Pc./Card
<b>41205</b>	Diamond	Clear	Carded	1 Pc./Card
<b>41206</b>	Diamond	Green	Carded	1 Pc./Card
<b>41207</b>	Diamond	Purple	Carded	1 Pc./Card
<b>41208</b>	Diamond	Red	Carded	1 Pc./Card
<b>41202</b>	Indented	-	Carded	1 Pc./Card



42103



42104



42105



42106



42107



42108



42109

### Chrome C.B. Microphone Cover

DESCRIPTION

- Chrome Plastic C.B. Microphone Cover
- Replaces Existing Cover, Available with or without Visor

Item #	Mic Type	Visor	Package	Pack
<b>41201</b>	Road King 56	Yes	Carded	1 Pc./Card
<b>40988</b>	Road King 56	No	Carded	1 Pc./Card
<b>40989</b>	A'636	No	Carded	1 Pc./Card



41201



40988



40989



### Stainless Microphone Grill

DESCRIPTION

- Replacement Stainless Steel C.B. Microphone Grill
- Available in Different Colors for 2 Different Models

Item #	Mic Type	Visor	Package	Pack
<b>40927</b>	Road King 56	Green	Carded	1 Pc./Card
<b>40928</b>	Road King 56	Purple	Carded	1 Pc./Card
<b>40929</b>	Road King 56	Red	Carded	1 Pc./Card
<b>40936</b>	A'636	Blue	Carded	1 Pc./Card
<b>40937</b>	A'636	Green	Carded	1 Pc./Card
<b>40938</b>	A'636	Purple	Carded	1 Pc./Card
<b>40939</b>	A'636	Red	Carded	1 Pc./Card



40927



40936



40928



40937



40929



40938



40939

# LED BULB



LED 1156 Bulb  
p. 108



LED 1157 Bulb  
p. 107



LED 3157 Bulb  
p. 109



LED 3156 Bulb  
p. 109



LED 194/912/921 Bulb  
p. 110



LED 1893 Bulb  
p. 111



LED 89 Bulb  
p. 111



LED 211-2 Bulb  
p. 112



## 2 High Power LED 1157 Bulb

### DESCRIPTION

- 1157 Bulb with 2 High Power 2 Watt LEDs, Super Bright, 250 Lumens
- Available in Amber, Red, and White
- Double Contact, Offset Pin

Item #	LEDs	Bulb Type	Package	Pack
<b>36932</b>	2 Amber	1157	Carded	1 Pc./Card
<b>36934</b>	2 Red	1157	Carded	1 Pc./Card
<b>36935</b>	2 White	1157	Carded	1 Pc./Card



## 13 LED 1157 Bulb - 360°

### DESCRIPTION

- 13 LED 360° 1157 Bulb
- 1157 Double Contact, Off Set Pin, **6 Month Warranty**

Item #	LEDs	Color	Package	Pack
<b>39862</b>	13	Amber	Carded	1 Pc./Card
<b>39863</b>	13	Red	Carded	1 Pc./Card
<b>39864</b>	13	White	Carded	1 Pc./Card

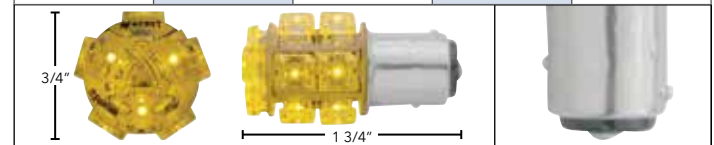

## 12 LED 1157 Bulb

### DESCRIPTION

- 1157 Bulb with 12 Super Bright LEDs
- 1157 Double Contact, Off Set Pin, **6 Month Warranty**

Item #	LEDs	Color	Package	Pack
<b>37690</b>	12	Amber	Carded	1 Pc./Card
<b>37691</b>	12	Blue	Carded	1 Pc./Card
<b>37692</b>	12	Red	Carded	1 Pc./Card
<b>37693</b>	12	White	Carded	1 Pc./Card

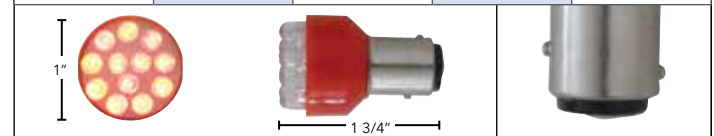

## 30 LED 1157 Bulbs - Right Angle

### DESCRIPTION

- Right Angle 1157 Bulb with 30 Super Bright LEDs
- 1157 Double Contact, Off Set Pin, Epoxy Sealed, **6 Month Warranty**

Item #	LEDs	Color	Package	Pack
<b>38788</b>	30	Amber	Carded	1 Pc./Card

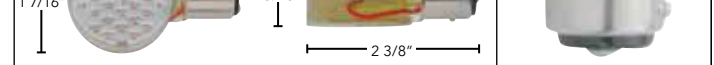

### 2 High Power LED 1156 Bulb

DESCRIPTION

- 1156 Bulb with 2 High Power 2 Watt LEDs, Super Bright, 250 Lumens
- Available in Amber, Red, and White
- Single Contact, Straight Pin

Item #	LEDs	Bulb Type	Package	Pack
<b>36928</b>	2 Amber	1156	Carded	1 Pc./Card
<b>36930</b>	2 Red	1156	Carded	1 Pc./Card
<b>36931</b>	2 White	1156	Carded	1 Pc./Card





### 13 LED 1156 Bulb - 360°

DESCRIPTION

- 13 LED 360° 1156 Bulb
- 1156 Single Contact, Straight Pin, **6 Month Warranty**

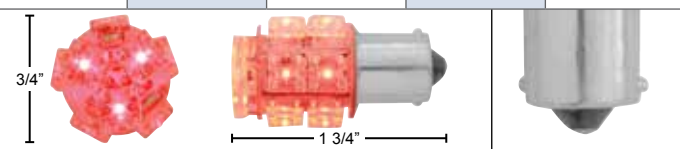
Item #	LEDs	Color	Package	Pack
<b>39865</b>	13	Amber	Carded	1 Pc./Card
<b>39866</b>	13	Red	Carded	1 Pc./Card
<b>39867</b>	13	White	Carded	1 Pc./Card





### 12 LED 1156 Bulb

DESCRIPTION

- 1156 Bulb with 12 Super Bright LEDs
- 1156 Single Contact, Straight Pin, **6 Month Warranty**

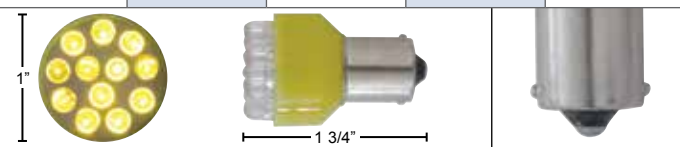
Item #	LEDs	Color	Package	Pack
<b>37686</b>	12	Amber	Carded	1 Pc./Card
<b>37687</b>	12	Blue	Carded	1 Pc./Card
<b>37688</b>	12	Red	Carded	1 Pc./Card





### 30 LED 1156 Bulb - Right Angle

DESCRIPTION

- Right Angle Bulb with 30 Super Bright LEDs
- 1156 Single Contact, Straight Pins, Epoxy Sealed, **6 Month Warranty**

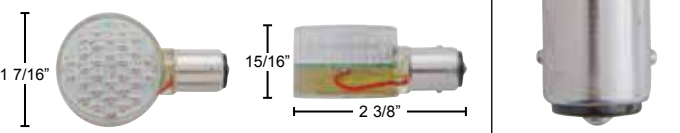
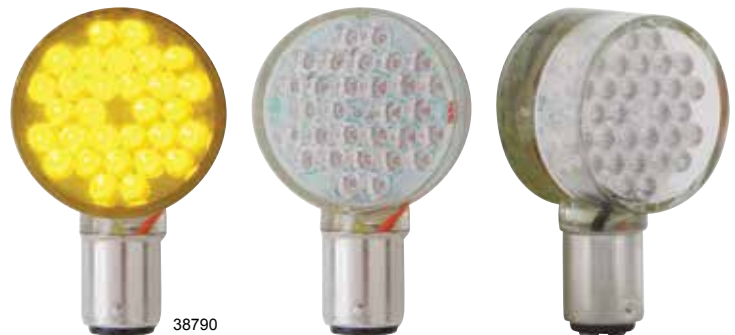
Item #	LEDs	Color	Package	Pack
<b>38790</b>	30	Amber	Carded	1 Pc./Card
<b>38791</b>	30	Red	Carded	1 Pc./Card





## 2 High Power LED 3157 Bulb

### DESCRIPTION

- 3157 Bulb with 2 High Power 2 Watt LEDs, Super Bright, 250 Lumens
- Available in Amber, Red, and White
- 3156 Single Contact, Wedge Base, **6 Month Warranty**

Item #	LEDs	Color	Package	Pack
<b>36547</b>	2 Amber	Amber	Carded	1 Pc./Card
<b>36549</b>	2 Red	Red	Carded	1 Pc./Card
<b>36550</b>	2 White	White	Carded	1 Pc./Card



## 12 LED 3157 Bulb

### DESCRIPTION

- 3157 Bulb with 12 LEDs
- 3157 Wedge Base, Epoxy Sealed, **6 Month Warranty**

Item #	LEDs	Color	Package	Pack
<b>38210</b>	12	Amber	Carded	1 Pc./Card
<b>38211</b>	12	Red	Carded	1 Pc./Card
<b>38341</b>	12	White	Carded	1 Pc./Card



## 2 High Power LED 3157 Bulb

### DESCRIPTION

- 3156 Bulb with 2 High Power 2 Watt LEDs, Super Bright, 250 Lumens
- Available in Amber, Red, and White
- 3156 Single Contact, Wedge Base, **6 Month Warranty**

Item #	LEDs	Color	Package	Pack
<b>36543</b>	2 Amber	Amber	Carded	1 Pc./Card
<b>36545</b>	2 Red	Red	Carded	1 Pc./Card
<b>36546</b>	2 White	White	Carded	1 Pc./Card



## 12 LED 3156 Bulb

### DESCRIPTION

- 3156 Bulb with 12 LEDs
- 3156 Wedge Base, Epoxy Sealed, **6 Month Warranty**

Item #	LEDs	Color	Package	Pack
<b>38209</b>	12	Red	Carded	1 Pc./Card



## High Power LED 194 / T10 Bulb

### DESCRIPTION

- High Power 12V 194 / T10 LED Bulb
- "Cree" LED, **6 Month Warranty**

Item #	LEDs	Color	Package	Pack
<b>36917</b>	1	Amber	Carded	2 Pcs./Card
<b>36920</b>	1	White	Carded	2 Pcs./Card

### 5 High Power LED 194 Bulb - 360°

DESCRIPTION

- 360° 194 Bulb with 5 High Power LED, 194 Wedge Base

Item #	LEDs	Color	Package	Pack
<b>37800</b>	5	Amber	Carded	2 Pcs./Card
<b>37801</b>	5	Blue	Carded	2 Pcs./Card
<b>37802</b>	5	Red	Carded	2 Pcs./Card
<b>37803</b>	5	White	Carded	2 Pcs./Card

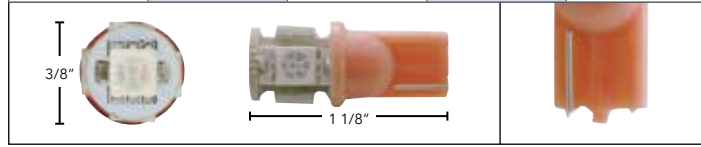

### 4 LED 194 Bulb

DESCRIPTION

- 4 LED 194 Bulb, Deluxe Packaging with 3 Bulbs Per Card, 194 Wedge Base

Item #	LEDs	Color	Package	Pack
<b>38272</b>	4	Amber	Carded	3 Pcs./Card
<b>38273</b>	4	Blue	Carded	3 Pcs./Card
<b>38274</b>	4	Green	Carded	3 Pcs./Card
<b>38276</b>	4	Red	Carded	3 Pcs./Card
<b>38277</b>	4	White	Carded	3 Pcs./Card



### LED 194 Bulb

DESCRIPTION

- 194 Bulb with 1 LED, 194 Wedge Base

Item #	LEDs	Color	Package	Pack
<b>38261</b>	1	Amber	Carded	2 Pcs./Card
<b>38262</b>	1	Blue	Carded	2 Pcs./Card
<b>38263</b>	1	Green	Carded	2 Pcs./Card
<b>38265</b>	1	Purple	Carded	2 Pcs./Card
<b>38264</b>	1	Red	Carded	2 Pcs./Card
<b>38266</b>	1	White	Carded	2 Pcs./Card



### 9 LED 194/912/921 Bulb

DESCRIPTION

- 194/912/921 Bulb with 9 Micro LEDs, 194/912/921 Wedge Base

Item #	LEDs	Color	Package	Pack
<b>37734</b>	9	Amber	Carded	2 Pcs./Card
<b>37735</b>	9	Blue	Carded	2 Pcs./Card
<b>37736</b>	9	Red	Carded	2 Pcs./Card
<b>37737</b>	9	White	Carded	2 Pcs./Card
<b>38332</b>	9	Purple	Carded	2 Pcs./Card

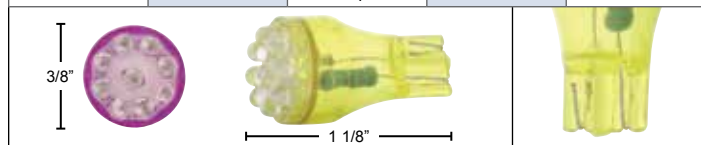

**4 LED 1893 Bulb**

## DESCRIPTION

- 1893 Bulb with 4 Micro LED Bulbs, Single Contact, Straight Pin

Item #	LEDs	Color	Package	Pack
<b>38566</b>	4	Amber	Carded	2 Pcs./Card
<b>38567</b>	4	Blue	Carded	2 Pcs./Card
<b>38568</b>	4	Green	Carded	2 Pcs./Card
<b>38570</b>	4	Red	Carded	2 Pcs./Card
<b>38571</b>	4	White	Carded	2 Pcs./Card

**1 LED 1893 Bulb**

## DESCRIPTION

- 1893 Bulb with 1 Large 10 mm LED Bulb, Single Contact, Straight Pin

Item #	LEDs	Color	Package	Pack
<b>38563</b>	1	Purple	Carded	2 Pcs./Card
<b>38565</b>	1	White	Carded	2 Pcs./Card

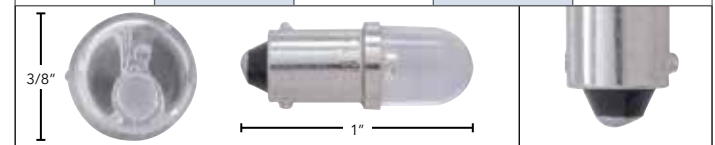
**9 LED 89 Bulb**

## DESCRIPTION

- 89 Bulb with 9 Super Bright LEDs, 7.3 Watts, **6 Month Warranty**

Item #	LEDs	Color	Package	Pack
<b>38990</b>	9	Blue	Carded	2 Pcs./Card
<b>38994</b>	9	White	Carded	2 Pcs./Card

**LED 37/BP2 Bulb**

## DESCRIPTION

- 37/BP2 Bulb with 1 Micro LED Bulb, Dash Application, **6 Month Warranty**

Item #	LEDs	Color	Package	Pack
<b>38343</b>	1	Amber	Carded	2 Pcs./Card
<b>38344</b>	1	Blue	Carded	2 Pcs./Card
<b>38345</b>	1	Green	Carded	2 Pcs./Card
<b>38346</b>	1	Purple	Carded	2 Pcs./Card
<b>38347</b>	1	Red	Carded	2 Pcs./Card
<b>38348</b>	1	White	Carded	2 Pcs./Card

**9 LED 904 Bulb**

DESCRIPTION

- 904 Bulb with 9 Super Bright LEDs, 9.3 Watts, **6 Month Warranty**

Item #	LEDs	Color	Package	Pack
<b>38983</b>	9	Blue	Carded	2 Pcs./Card
<b>38984</b>	9	Green	Carded	2 Pcs./Card
<b>38986</b>	9	Red	Carded	2 Pcs./Card

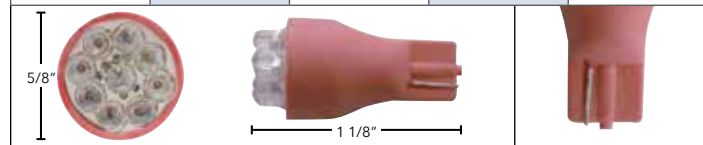

**LED 211-2 Bulb**

DESCRIPTION

- 211-2 Bulb with 8 Micro LEDs, **6 Month Warranty**

Item #	LEDs	Color	Package	Pack
<b>38572</b>	8	Amber	Carded	2 Pcs./Card
<b>38573</b>	8	Blue	Carded	2 Pcs./Card
<b>38576</b>	8	Red	Carded	2 Pcs./Card
<b>38577</b>	8	White	Carded	2 Pcs./Card

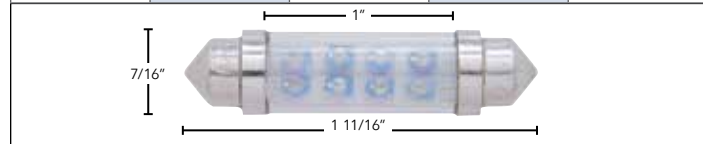

**6 LED 6418/6461 Bulb - 36 mm**

DESCRIPTION

- 36 mm 6418/6461 Bulb with 6 Micro LEDs, **6 Month Warranty**

Item #	LEDs	Color	Package	Pack
<b>38531</b>	6	Blue	Carded	2 Pcs./Card
<b>38532</b>	6	Green	Carded	2 Pcs./Card
<b>38534</b>	6	Red	Carded	2 Pcs./Card
<b>38535</b>	6	White	Carded	2 Pcs./Card

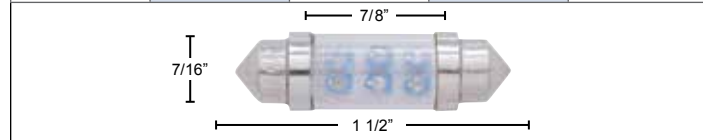

# LED ACCESSORIES

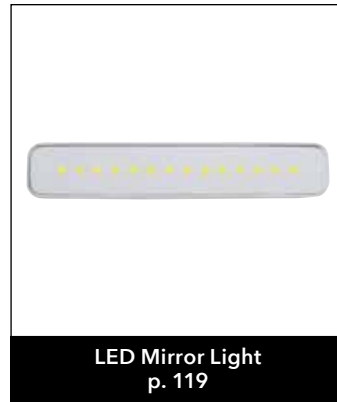
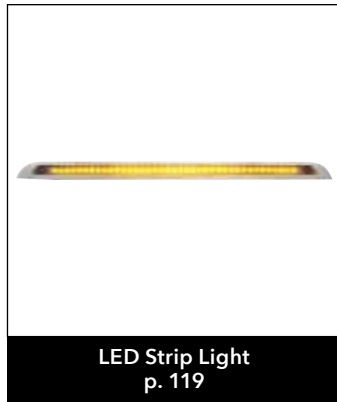
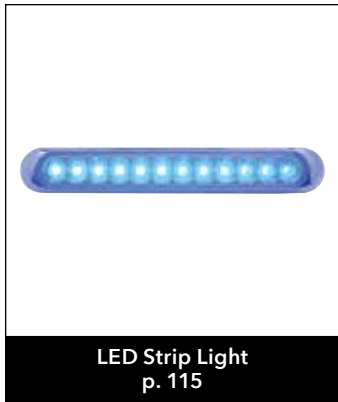
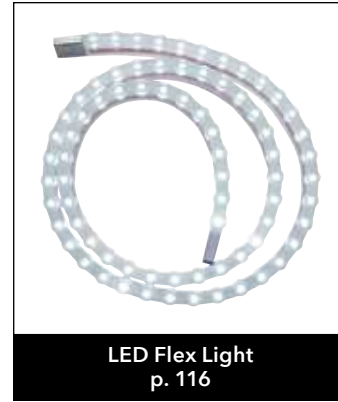

# LED ACCESSORIES

### 39 High Power LED Dome Light

DESCRIPTION

- 39 High Power LED, 7 1/4" Round Dome Light with Chrome Bezel
- 12V/24V Application, **6 Month Warranty**

Item #	Description	Package	Pack
<b>37626B</b>	LED Dome Light	Bulk	1 Pc.

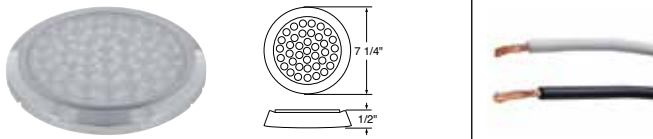



### 21 High Power LED Dome Light

DESCRIPTION

- 21 High Power LED, 6 1/4" Round Dome Light with Chrome Bezel
- 12V/24V Application, **6 Month Warranty**

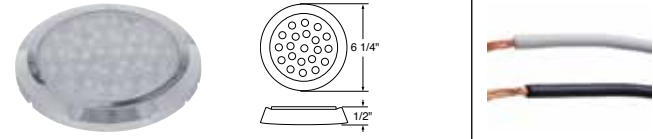
Item #	Description	Package	Pack
<b>37625B</b>	LED Dome Light	Bulk	1 Pc.





### 4 LED Dome Light

DESCRIPTION

- 4 Super Bright LED Auxiliary Light with Chrome Plastic Bezel
- 2 Wires (Hard Wired), Mounting Holes are 2 3/16" Apart, **6 Month Warranty**

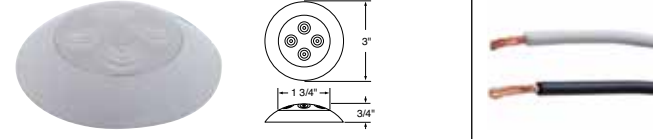
Item #	LEDs	Lens	Package	Pack
<b>38931</b>	4 Amber	Clear	Carded	1 Pc./Card
<b>38936</b>	4 White	Clear	Carded	1 Pc./Card



38931

38936

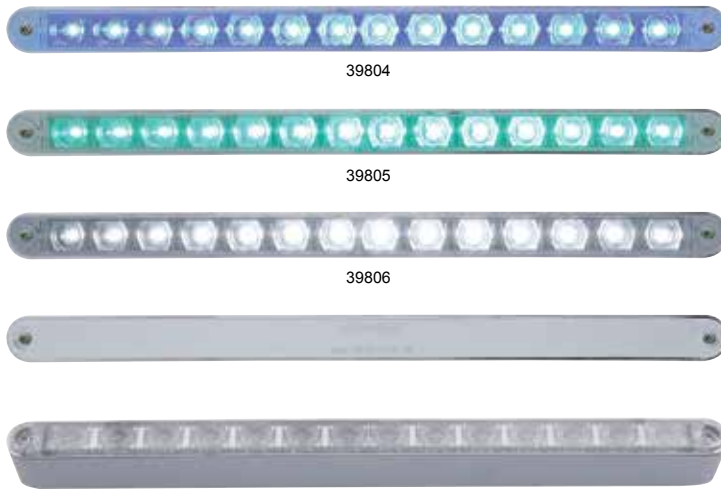
**14 LED 12" Light Bar**

## DESCRIPTION

- 14 LED 12" Light Bar with Chrome Plastic Bezel
- Available in Blue, Green, or White LEDs with Clear Lens
- Amber and Red LEDs Available with Chrome Lens
- 12" Chrome Plastic Light Bar Bezel Available Separately: Item # 30933B
- Mounting Screws Can Be Moved to Accommodate Mounting Distance from 4 1/2" to 7 3/8" Apart, **6 Month Warranty**

Item #	LEDs	Lens	Light	Pack
<b>39804</b>	14 Blue	Clear	39483B	1 Pc./Card
<b>39805</b>	14 Green	Clear	39484B	1 Pc./Card
<b>39806</b>	14 White	Clear	39485B	1 Pc./Card
<b>39698</b>	14 Amber	Chrome	39644B	1 Pc./Card
<b>39699</b>	14 Red	Chrome	39645B	1 Pc./Card

**14 LED 12" Light Bar**

## DESCRIPTION

- 14 LED 12" Light Bar
- 2 Wires, Approximate Size: 12" W x 5/8" L
- Available in Blue, Green, or White LEDs with Clear Lens
- Amber and Red LEDs Available with Chrome Lens
- Mounting Holes Approximately 11 7/16" Apart, **6 Month Warranty**

Item #	LEDs	Lens	Package	Pack
<b>39483B</b>	14 Blue	Clear	Bulk	1 Pc.
<b>39484B</b>	14 Green	Clear	Bulk	1 Pc.
<b>39485B</b>	14 White	Clear	Bulk	1 Pc.
<b>39644B</b>	14 Amber	Chrome	Bulk	1 Pc.
<b>39645B</b>	14 Red	Chrome	Bulk	1 Pc.

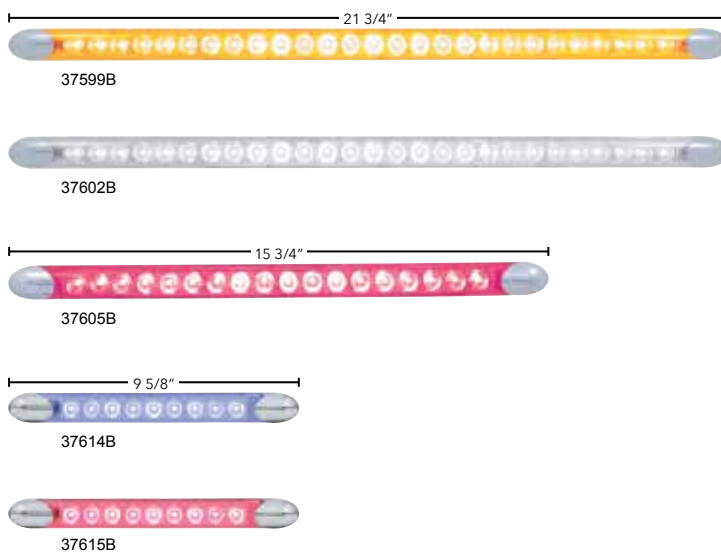
**High Power LED Light Bar**

## DESCRIPTION

- High Power LED Light Bar with 27, 18, or 9 High Power LEDs
- Available in 21 3/4", 15 3/4", 9 5/8" Length, 1" Wide, 5/8" Tall
- Available with Amber, Blue, Red, or White LED and Clear Lens, **6 Month Warranty**

**27 LED 21 3/4" Light Bar**

Item #	LEDs	Lens	Package	Pack
<b>37599B</b>	Amber	Clear	Bulk	1 Pc.
<b>37602B</b>	White	Clear	Bulk	1 Pc.

**18 LED 15 3/4" Light Bar**

Item #	LEDs	Lens	Package	Pack
<b>37605B</b>	Red	Clear	Bulk	1 Pc.

**9 LED 9 5/8" Light Bar**

Item #	LEDs	Lens	Package	Pack
<b>37614B</b>	Blue	Clear	Bulk	1 Pc.
<b>37615B</b>	Red	Clear	Bulk	1 Pc.

### 45 LED 35 1/4" Flex Light

DESCRIPTION

- 45 Super Bright LED Flex Light, Approximately 35 1/4" Long
- Available in Amber, Blue, Red, or White LEDs
- Please Specify Wire Exit Position, Wires can Exit on the Left or Right Side
- When the LED is Pointed Forward, **6 Month Warranty**

Item #	LEDs	Wire Exit	Package	Pack
<b>37655</b>	45 Amber	Left	Carded	1 Pc./Card
<b>37656</b>	45 Amber	Right	Carded	1 Pc./Card
<b>37657</b>	45 Blue	Left	Carded	1 Pc./Card
<b>37658</b>	45 Blue	Right	Carded	1 Pc./Card
<b>37623</b>	45 Red	Left	Carded	1 Pc./Card
<b>37624</b>	45 Red	Right	Carded	1 Pc./Card
<b>37659</b>	45 White	Left	Carded	1 Pc./Card
<b>37660</b>	45 White	Right	Carded	1 Pc./Card

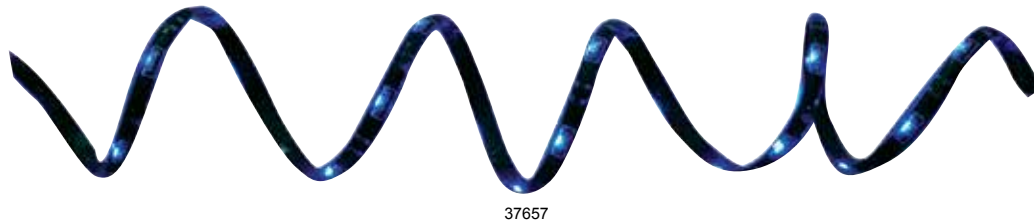

### 30 LED 40" Flex Light

DESCRIPTION

- Super Bright LED Flex Light, Available in 20" Length with 15 LEDs or
- 40" Length with 30 LEDs, Heavy Duty Design
- Available with Amber, Blue, Red, or White LEDs, **6 Month Warranty**

Item #	LEDs	Color	Length	Pack
<b>37244</b>	30	Blue	40"	1 Pc./Card
<b>37246</b>	30	White	40"	1 Pc./Card

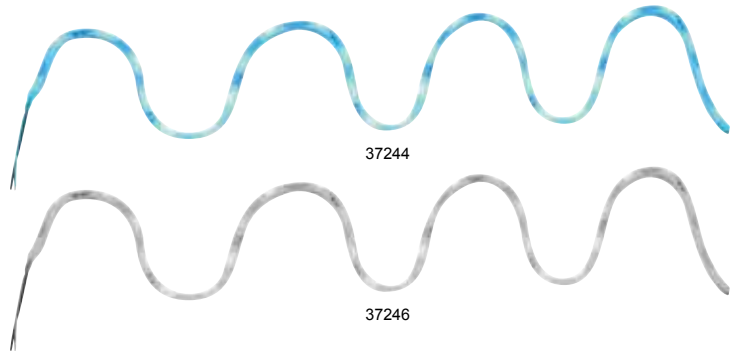

### 30 LED 19 1/2" Flex Light - Side Illumination

DESCRIPTION

- 30 Super Bright LED Flex Light, Approximately 19 1/2" Long, 12 Volt
- Available in Amber, Blue, Green, Red, or White LEDs, **6 Month Warranty**
- Easily Attaches with Pre-Applied Adhesive Tape, Side Illumination LEDs
- Can be Used as Accent Lighting Under Dash Edges, Arm Rests, Inside Trunk and Engine Compartment, Not Designed or Warranted for Exterior Use, but Many Custom Builders have used these on Exterior with Great Success

Item #	LEDs	Color	Package	Pack
<b>37954</b>	30	Amber	Carded	1 Pc./Card
<b>37955</b>	30	Blue	Carded	1 Pc./Card
<b>37957</b>	30	Red	Carded	1 Pc./Card

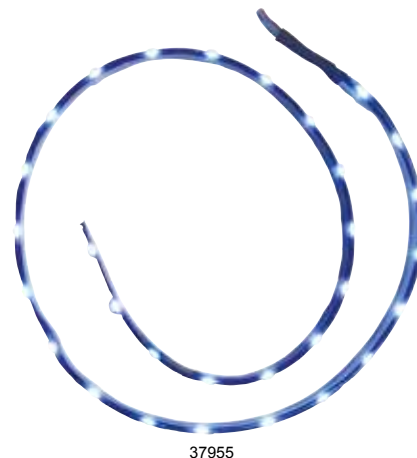



**12 LED 12" Flex Light - Connectible**

## DESCRIPTION

- 12" Connectible LED Light
- Available with Amber, Blue, Green, Red, or White LEDs
- Includes Wire Plug & Light Connector, **6 Month Warranty**

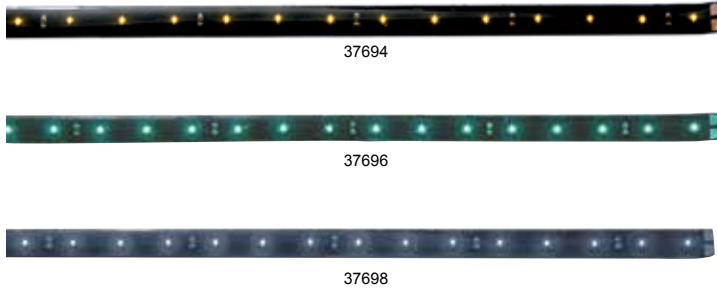

Item #	LEDs	Color	Package	Pack
<b>37694</b>	12	Amber	Carded	1 Pc./Card
<b>37696</b>	12	Green	Carded	1 Pc./Card
<b>37698</b>	12	White	Carded	1 Pc./Card

**12 LED 10 3/4" Flex Light**

## DESCRIPTION

- 12 Super Bright LED Flex Light, Approximately 10 3/4" Long
- Available with Amber, Blue, Red, or White LEDs
- Wire Exit Center of the Strip, **6 Month Warranty**

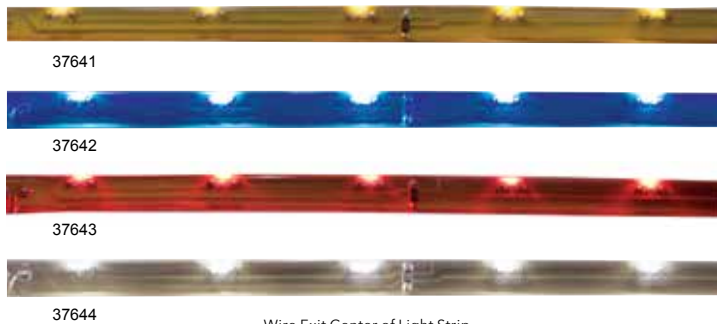

Item #	LEDs	Color	Package	Pack
<b>37641</b>	12	Amber	Carded	1 Pc./Card
<b>37642</b>	12	Blue	Carded	1 Pc./Card
<b>37643</b>	12	Red	Carded	1 Pc./Card
<b>37644</b>	12	White	Carded	1 Pc./Card



### 12 LED 4 1/4" Oval Auxiliary Light

DESCRIPTION

- 12 Super Bright LED Light, Chrome Plastic Housing, Water Resistant
- 2 Wires (Hard Wired), Mounting Holes are 7/8" Apart, **6 Month Warranty**

Item #	LEDs	Color	Package	Pack
<b>38056</b>	12	Red	Carded	1 Pc./Card



### 12 LED 6 1/4" Auxiliary Light

DESCRIPTION

- 12 Super Bright LED Strip Light, Chrome Plastic Housing, Water Resistant
- Available in Amber, Blue, Red and White, Install Anywhere
- 2 Wires (Hard Wired), Mounting Holes are 2 3/4" Apart, **6 Month Warranty**

Item #	LEDs	Color	Package	Pack
<b>38042</b>	12	Amber	Carded	1 Pc./Card
<b>38043</b>	12	Blue	Carded	1 Pc./Card
<b>38044</b>	12	Red	Carded	1 Pc./Card
<b>38045</b>	12	White	Carded	1 Pc./Card



38043

### 7 LED 4" Auxiliary Light

DESCRIPTION

- 7 Super Bright LED Strip Light, Chrome Plastic Housing, Water Resistant
- Available in Amber, Blue, Red and White, Install Anywhere
- 2 Wires (Hard Wired), Mounting Holes are 5/8" Apart, **6 Month Warranty**

Item #	LEDs	Color	Package	Pack
<b>38047</b>	7	Blue	Carded	1 Pc./Card
<b>38048</b>	7	Red	Carded	1 Pc./Card
<b>38049</b>	7	White	Carded	1 Pc./Card



38047

### 3 High Power LED 1" Clearance / Marker Light with Visor

DESCRIPTION

- 3 High Power LED 1" Clearance/Marker Light with Chrome Plastic Visor.
- Available in Amber, Blue, Red, or White LED with Clear Lens, **6 Month Warranty**

Item #	LEDs	Color	Package	Pack
<b>36905</b>	3	Amber	Carded	1 Pc./Card
<b>36906</b>	3	Blue	Carded	1 Pc./Card
<b>36907</b>	3	Red	Carded	1 Pc./Card
<b>36908</b>	3	White	Carded	1 Pc./Card



36905

36906

36907

36908

**39 LED 19" Auxiliary Light**

## DESCRIPTION

- 39 Super Bright LED Strip Light, Chrome Plastic Housing
- Approximately 16" L x 2" W x 1" H, Mounting Holes are 14 1/2" Apart
- 2 Wires, Tape or Screw Mount, Double Sided Tape on Back, **6 Month Warranty**

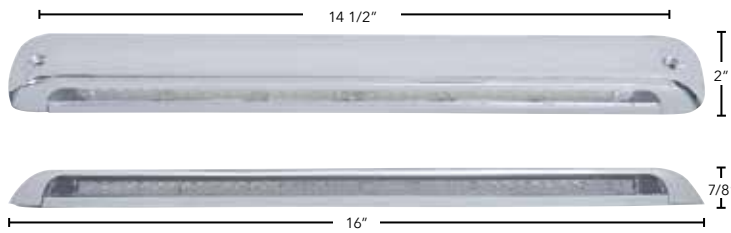

Item #	LEDs	Color	Package	Pack
<b>38866</b>	39	Amber	Carded	1 Pc./Card
<b>38870</b>	39	Red	Carded	1 Pc./Card



38866

**14 LED 6" Mirror Light**

## DESCRIPTION

- 14 Super Bright LED, Chrome Plastic Housing, Mirror Lens, 2 Wires
- Looks Great Anywhere, 2 Wires (Hard Wired), **6 Month Warranty**

Item	LEDs	Color	Package	Pack
<b>38872</b>	14	Amber	Carded	1 Pc./Card
<b>38873</b>	14	Blue	Carded	1 Pc./Card
<b>38874</b>	14	Green	Carded	1 Pc./Card
<b>38877</b>	14	White	Carded	1 Pc./Card

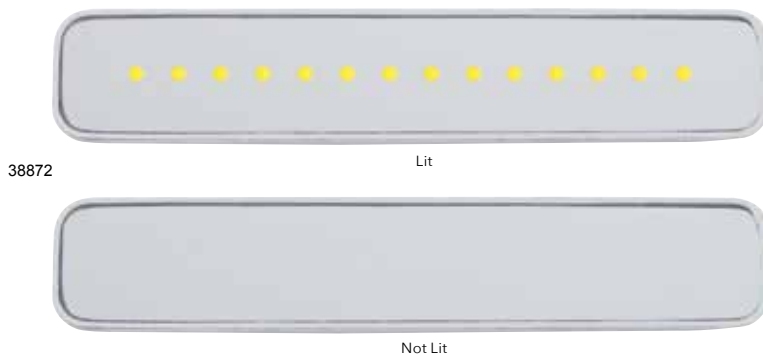

38872

Lit

Not Lit

**\*Unique Mirror Lens Design**  
Light Shines Through When LEDs Are Lit,  
Looks Like A Mirror When LEDs Are Not Lit

**8 LED 4" Auxiliary Light**

## DESCRIPTION

- 8 Super Bright LED Strip Light, Chrome Plastic Housing
- 2 Wires (Hard Wired), Double Sided Tape Mount, **6 Month Warranty**

Item #	LEDs	Color	Package	Pack
<b>39712</b>	8	Blue	Carded	2 Pcs./Card
<b>39715</b>	8	Red	Carded	2 Pcs./Card



39712

39715

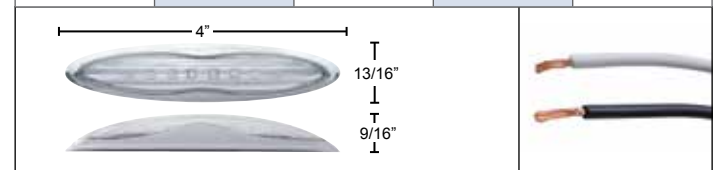

### 5 LED 2 3/4" Auxiliary Light

DESCRIPTION

- 5 Super Bright LED Strip Light, Chrome Plastic Housing, Water Resistant
- 2 Wires (Hard Wired), **6 Month Warranty**

Item #	LEDs	Color	Package	Pack
<b>38008</b>	5	Amber	Carded	1 Pc./Card



### 4 LED 2" Auxiliary Light

DESCRIPTION

- 4 Super Bright LED Strip Light, Approx. 2" Long
- 2 Wires (Hard Wired), **6 Month Warranty**

Item #	LEDs	Color	Package	Pack
<b>38760</b>	4	Amber	Carded	1 Pc./Card



### 6 LED Half-Moon Light

DESCRIPTION

- 6 Super Bright LED Auxiliary Light, Half-Moon Chrome Plastic Housing
- 2 Wires (Hard Wired), **6 Month Warranty**

Item #	LEDs	Color	Package	Pack
<b>38554</b>	6	Amber	Carded	1 Pc./Card
<b>38555</b>	6	Blue	Carded	1 Pc./Card
<b>38558</b>	6	Red	Carded	1 Pc./Card
<b>38559</b>	6	White	Carded	1 Pc./Card



38554

### 4 LED Fastener

DESCRIPTION

- 4 Super Bright LED Fastener, Chrome Plastic Housing, Water Resistant
- Require 3/4" Diameter Hole for Installation, 7 1/4" Wire Lead
- 2 Wires (Hard Wired), **6 Month Warranty**

Item #	LEDs	Color	Package	Pack
<b>38686</b>	4	Amber	Carded	1 Pc./Card
<b>38687</b>	4	Blue	Carded	1 Pc./Card
<b>38690</b>	4	Red	Carded	1 Pc./Card
<b>38691</b>	4	White	Carded	1 Pc./Card



38686



38687



38690



38691



### LED Fastener

#### DESCRIPTION

- Super Bright LED Fastener, Stainless Steel Housing, Perfect for License Plate
- Available in Amber, Blue, Red, or White LED, 8 1/2" Wire Lead
- 2 Wires (Hard Wired), **6 Month Warranty**

Item #	LEDs	Color	Package	Pack
<b>70300</b>	1	Amber	Carded	2 Pcs./Card
<b>70301</b>	1	Blue	Carded	2 Pcs./Card
<b>70302</b>	1	Red	Carded	2 Pcs./Card
<b>70303</b>	1	White	Carded	2 Pcs./Card



### LED Bullet Fastener

#### DESCRIPTION

- Super Bright LED Bullet Fastener, Chrome Housing, Perfect for License Plate
- Available in Amber, Blue, Red and White, Install Anywhere
- Single Wire (Self Grounding), **6 Month Warranty**

Item #	LEDs	Color	Package	Pack
<b>10863</b>	1	Amber	Carded	2 Pcs./Card
<b>10864</b>	1	Blue	Carded	2 Pcs./Card
<b>10867</b>	1	Red	Carded	2 Pcs./Card
<b>10862</b>	1	White	Carded	2 Pcs./Card



### LED Indicator Light

#### DESCRIPTION

- Indicator Light with 1 Super Bright LED
- Require 1/4" Diameter Hole for Installation, **6 Month Warranty**

Item #	Color	Package	Pack
<b>39314</b>	Amber	Carded	1 Pc./Card
<b>39314B</b>	Amber	Bulk	1 Pc.
<b>39315</b>	Blue	Carded	1 Pc./Card
<b>39315B</b>	Blue	Bulk	1 Pc.
<b>39316</b>	Green	Carded	1 Pc./Card
<b>39316B</b>	Green	Bulk	1 Pc.
<b>39317</b>	Purple	Carded	1 Pc./Card
<b>39317B</b>	Purple	Bulk	1 Pc.
<b>39318</b>	Red	Carded	1 Pc./Card
<b>39318B</b>	Red	Bulk	1 Pc.
<b>39319</b>	White	Carded	1 Pc./Card
<b>39319B</b>	White	Bulk	1 Pc.

**1 LED Bulb**

## DESCRIPTION

- 1 LED 12V Bulb with 47" Wire Lead
- Available in Amber, Blue, Green, or Red LED
- 2 Wires (Hard Wired), 6 Month Warranty, **6 Month Warranty**

Item #	LEDs	Color	Package	Pack
<b>37804B</b>	1	Amber	Bulk	1 Pc.
<b>37805B</b>	1	Blue	Bulk	1 Pc.
<b>37806B</b>	1	Green	Bulk	1 Pc.
<b>37807B</b>	1	Red	Bulk	1 Pc.

**5 LED Map Light**

## DESCRIPTION

- 5 Super Bright LED Map Light, Chrome Plastic Housing
- Plugs into any Cigarette Lighter Socket, **6 Month Warranty**

Item #	LEDs	Color	Package	Pack
<b>38543</b>	5	Blue	Carded	1 Pc./Card
<b>38546</b>	5	Red	Carded	1 Pc./Card

**Hot Item!****United Pacific Beach Cruiser**

## DESCRIPTION

- United Pacific Beach Cruiser
- Live the California Life Style, Single Speed, Foot Break

Item #	Description	Package	Pack
<b>99083</b>	Beach Cruiser	Boxed	1 Pc./Box



# MISC. INTERIOR ACCESSORIES

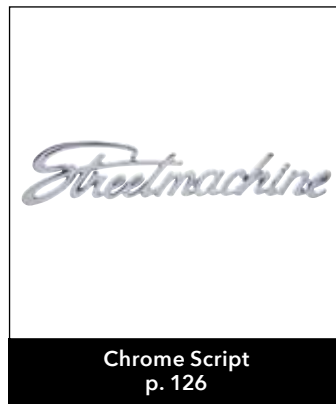
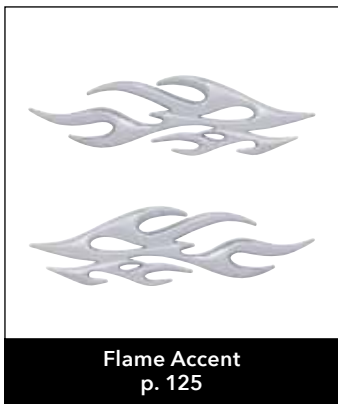

# MISC. INTERIOR ACCESSORIES

**Skull Accent**

DESCRIPTION

- Chrome Die Cast Skull Accent, Unique Skull Design
- Mounts to Any Flat Surface, Mounting Screws are Approximately 2 3/4" Apart

Item #	Description	Package	Pack
<b>88122</b>	Skull Accent	Carded	1 Pc./Card



**Flaming Skull Accent**

DESCRIPTION

- Chrome Plastic Flaming Skull Accent
- Double-Sided Tape on Back, Approximate size: 2 7/8" x 7 1/4"

Item #	Description	Package	Pack
<b>50102</b>	Flame Skull - Face Left	Carded	1 Pc./Card
<b>50103</b>	Flame Skull - Face Right	Carded	1 Pc./Card

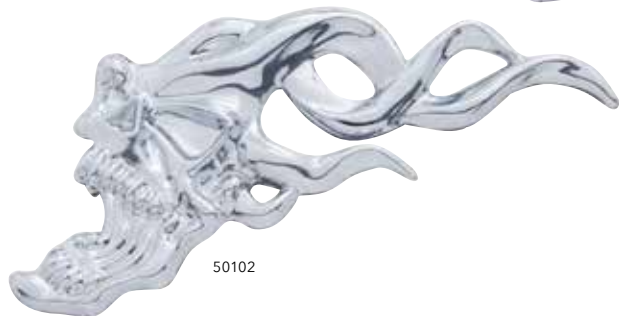

**Bull Balls Accent**

DESCRIPTION

- Chrome Plastic Bull Balls Accent
- Double-Sided Tap on Back, Available 4 1/2" L or 2 1/2" L

Item #	Description	Package	Pack
<b>50105</b>	4 1/2" Bull Balls Accent	Carded	1 Pc./Card
<b>50106</b>	2 1/2" Bull Balls Accent	Carded	1 Pc./Card



**Flaming Skull Accent**

DESCRIPTION

- Chrome Plastic Flaming Skull Accent
- Double Sided Tape on Back, Approximate Size: 6 1/8" x 5 9/16", 3 3/4" x 1 1/4"
- Sold in 2 Pieces per Set

Item #	Description	Package	Pack
<b>50104</b>	Large Flame Accent	Carded	1 Set/Card



**Skull Accent**

DESCRIPTION

- Chrome Plastic Skull Accent
- Double Sided Tape on Back, Approximate Size: 7 1/4" x 2 1/2", x 1 1/4"

Item #	Description	Package	Pack
<b>50112</b>	Skull Accent	Carded	1 Pc./Card





**Maltese Cross Accent**

## DESCRIPTION

- Chrome Plastic Maltese Cross Accent
- Double-Sided Tape on Back, Approximate Size: 4" x 4"

Item #	Description	Package	Pack
<b>50101</b>	Maltese Cross Accent	Carded	1 Pc./Card

**Skull Accent**

## DESCRIPTION

- Chrome Plastic Skull Accent
- Double-Sided Tape on Back, Approximate Size: 5 1/2" x 3 3/4"

Item #	Description	Package	Pack
<b>50100</b>	Skull Accent	Carded	1 Pc./Card

**Flame Accent**

## DESCRIPTION

- Chrome Plastic Flame Accent
- Double Sided Tape on Back, Approximate Size: 7 3/4" x 2 1/4"

Item #	Description	Package	Pack
<b>41088</b>	Flame Accent - Face Left	Carded	1 Pc./Card
<b>41087</b>	Flame Accent - Face Right	Carded	1 Pc./Card



41087



41088

**Eagle Accent**

## DESCRIPTION

- Chrome Plastic Eagle Accent
- Double-Sided Tape on Back, Approximate Size: 7" x 6"

Item #	Description	Package	Pack
<b>50111</b>	Eagle Accent - Face Left	Carded	1 Pc./Card
<b>50110</b>	Eagle Accent - Face Right	Carded	1 Pc./Card



50110

50111

**Eagle Accent**

## DESCRIPTION

- Chrome Plastic Highly Detailed Bald Eagle Accent
- Double-Sided Tape on Back, Approximate Size: 7 3/16" x 1 3/4"

Item #	Description	Package	Pack
<b>50119</b>	Eagle Accent	Carded	1 Pc./Card



**Chrome Script**

## DESCRIPTION

- Chrome Script Emblem, Stud Mounted, Universal Application
- Available with 3 Different Scripts

Item #	Description	Package	Pack
<b>S1001</b>	"Hotrod"	Carded	1 Pc./Card
<b>S1002</b>	"Streetmachine"	Carded	1 Pc./Card
<b>A6202</b>	"Streetrod"	Carded	1 Pc./Card



S1001



S1002



A6202

**Chrome Letters**

## DESCRIPTION

- Chrome Plastic Letters, 1" Tall
- Double Sided Tape Mount

Item #	Description	Package	Pack
<b>50150</b>	A	Hang Packed	1 Pc./Pack
<b>50151</b>	B	Hang Packed	1 Pc./Pack
<b>50152</b>	C	Hang Packed	1 Pc./Pack
<b>50153</b>	D	Hang Packed	1 Pc./Pack
<b>50154</b>	E	Hang Packed	1 Pc./Pack
<b>50155</b>	F	Hang Packed	1 Pc./Pack
<b>50156</b>	G	Hang Packed	1 Pc./Pack
<b>50157</b>	H	Hang Packed	1 Pc./Pack
<b>50158</b>	I	Hang Packed	1 Pc./Pack
<b>50159</b>	J	Hang Packed	1 Pc./Pack
<b>50160</b>	K	Hang Packed	1 Pc./Pack
<b>50161</b>	L	Hang Packed	1 Pc./Pack
<b>50162</b>	M	Hang Packed	1 Pc./Pack
<b>50163</b>	N	Hang Packed	1 Pc./Pack
<b>50164</b>	O	Hang Packed	1 Pc./Pack
<b>50165</b>	P	Hang Packed	1 Pc./Pack
<b>50166</b>	Q	Hang Packed	1 Pc./Pack
<b>50167</b>	R	Hang Packed	1 Pc./Pack
<b>50168</b>	S	Hang Packed	1 Pc./Pack
<b>50169</b>	T	Hang Packed	1 Pc./Pack
<b>50170</b>	U	Hang Packed	1 Pc./Pack
<b>50171</b>	V	Hang Packed	1 Pc./Pack
<b>50172</b>	W	Hang Packed	1 Pc./Pack
<b>50173</b>	X	Hang Packed	1 Pc./Pack
<b>50174</b>	Y	Hang Packed	1 Pc./Pack
<b>50175</b>	Z	Hang Packed	1 Pc./Pack
<b>50176</b>	1	Hang Packed	1 Pc./Pack
<b>50177</b>	2	Hang Packed	1 Pc./Pack
<b>50178</b>	3	Hang Packed	1 Pc./Pack
<b>50179</b>	4	Hang Packed	1 Pc./Pack
<b>50180</b>	5	Hang Packed	1 Pc./Pack
<b>50181</b>	6	Hang Packed	1 Pc./Pack
<b>50182</b>	7	Hang Packed	1 Pc./Pack
<b>50183</b>	8	Hang Packed	1 Pc./Pack
<b>50184</b>	9	Hang Packed	1 Pc./Pack
<b>50185</b>	0	Hang Packed	1 Pc./Pack



A B C D  
E F G H  
I J K L  
M N O P  
Q R S T  
U V W X  
Y Z 1 2  
3 4 5 6  
7 8 9 0

**Stainless Steel Balls**

DESCRIPTION

- 8" Stainless Steel Balls
- Also Available as a Bell

Item #	Description	Package	Pack
<b>70148</b>	Stainless Bull Balls	Bulk	1 Pc.
<b>70143</b>	Stainless Bull Balls Bell	Bulk	1 Pc.



**LED Balls**

DESCRIPTION

- 8" Large Plastic Balls with 13 LED Lights
- Available in 2 Different Colors, 2 1/2" Lights Included

Item #	LEDs	Color	Package	Pack
<b>70392</b>	13	Blue	Bulk	1 Pc.
<b>70390</b>	13	Red	Bulk	1 Pc.



**Balls**

DESCRIPTION

- 8" Plastic Balls
- Available in 8 Different Colors

**Solid Color**

Item #	Color	Style	Package	Pack
<b>70145</b>	Black	Solid Color	Bulk	1 Pc.
<b>70144</b>	Blue	Solid Color	Bulk	1 Pc.
<b>70149</b>	Pink	Solid Color	Bulk	1 Pc.
<b>70147</b>	Red	Solid Color	Bulk	1 Pc.
<b>70146</b>	Tan	Solid Color	Bulk	1 Pc.

**Clear Color**

Item #	Color	Style	Package	Pack
<b>70385</b>	Blue	Clear	Bulk	1 Pc.
<b>70388</b>	Red	Clear	Bulk	1 Pc.
<b>70389</b>	Tan	Clear	Bulk	1 Pc.



**Novelty Key Chain - Balls**

DESCRIPTION

- Novelty Balls Key Chain
- Available in 2 Different Sizes (2 1/2" or 4 1/2") and Materials (Metal or Plastic)

**2 1/2" Small Balls Novelty Key Chain**

Item #	Color	Material	Package	Pack
<b>78010</b>	Chrome	Metal	Carded	1 Pc./Card
<b>78009</b>	Gold	Metal	Carded	1 Pc./Card
<b>78009B</b>	Gold	Metal	Bulk	1 Pc.
<b>78011</b>	Black	Plastic	Carded	1 Pc./Card
<b>78012</b>	Blue	Plastic	Carded	1 Pc./Card
<b>78008</b>	Pink	Plastic	Carded	1 Pc./Card
<b>78008B</b>	Pink	Plastic	Bulk	1 Pc.
<b>78013</b>	Red	Plastic	Carded	1 Pc./Card
<b>78013B</b>	Red	Plastic	Bulk	1 Pc.
<b>78014</b>	Tan	Plastic	Carded	1 Pc./Card
<b>78014B</b>	Tan	Plastic	Bulk	1 Pc.



78010

**4 1/2" Small Balls Novelty Key Chain**

Item #	Color	Material	Package	Pack
<b>78019</b>	Chrome	Metal	Carded	1 Pc./Card
<b>78015</b>	Black	Plastic	Carded	1 Pc./Card
<b>78016</b>	Blue	Plastic	Carded	1 Pc./Card
<b>78016B</b>	Blue	Plastic	Bulk	1 Pc.
<b>78017</b>	Red	Plastic	Carded	1 Pc./Card
<b>78018</b>	Tan	Plastic	Carded	1 Pc./Card



78009



78011



78012



78008



78013



78014

**Deco Diamond Plate**

DESCRIPTION

- Chrome Plastic Deco Diamond Plate
- Measurement: 24" W x 47" L

Item #	Description	Package	Pack
<b>70700</b>	Deco Diamond Plate	Boxed	1 Pc./Box



**Novelty Key Chain - Rubber Chicken**

DESCRIPTION

- Novelty Rubber Chicken Key Chain
- Approximately 5" Long

Item #	Description	Package	Pack
<b>78001</b>	Rubber Chicken	Carded	1 Pc./Card



**Fuzzy 8 Ball**

DESCRIPTION

- 3" Round Fuzzy 8 Ball
- Classic Lucky 8 Ball

Item #	Description	Package	Pack
<b>70204</b>	Fuzzy 8 Ball	Hang Packed	1 Set/Pack



**Fuzzy Dice - 3" x 3"**

DESCRIPTION

- Classic Fuzzy Dice

Item #	Description	Package	Pack
<b>C5038K</b>	Black	Bulk	1 Set
<b>C5038B</b>	Blue	Bulk	1 Set
<b>C5038R</b>	Red	Bulk	1 Set
<b>C5038W</b>	White	Bulk	1 Set



# MERCHANDISING

## United Pacific Store Display

### DESCRIPTION

- United Pacific Store Display

Item #	Description	Package	Pack
99073	United Pacific Store Display	Boxed	1 Pc./Box



## Exhaust Display

### DESCRIPTION

- Display for United Exhaust Systems  
 - Exhaust Not Included, Assembly Required

Item #	Description	Package	Pack
99017	Exhaust Display	Bulk	1 Set

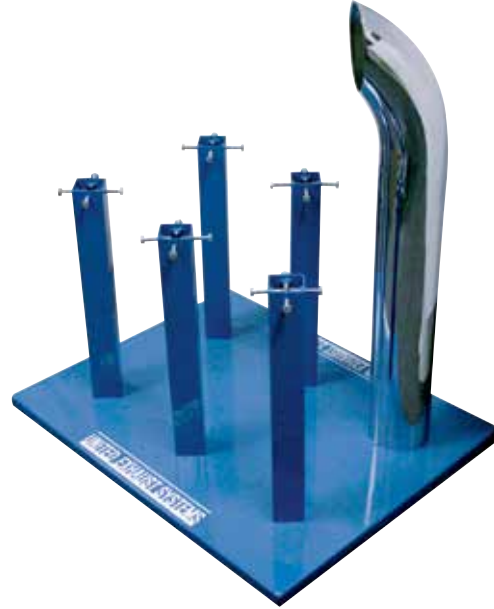

## Quarter Fender/Mud Hanger Display

### DESCRIPTION

- Quarter Fender/Mud Hanger Display

Item #	Description	Package	Pack
99068	Quarter Fender/Mud flap Hanger Display	Boxed	1 Set/Box



## United Pacific Bar Stool

### DESCRIPTION

- United Pacific Bar Stool

Item #	Description	Package	Pack
99041	Bar Stool	Bulk	1 Pc.



**United Pacific Light Display**

DESCRIPTION

- United Pacific Light Display for Various Lights
- Available in 1 Set

Item #	Description	Package	Pack
99019	Warning Light Display	Boxed	1 Set/Box
99042	Pedestal Light Display	Boxed	1 Set/Box
99043	Reflector Light Display	Boxed	1 Set/Box
99056	Stainless Steel Light Display	Boxed	1 Set/Box
99065	Headlight Light Display	Boxed	1 Set/Box
99071	Peterbilt Front Turn Signal Light Display	Boxed	1 Set/Box
99074	Work Light Display	Boxed	1 Set/Box



99019



99042



99074



99065



99071



99043



99056

**United Pacific LED "GLO" Light Display**

DESCRIPTION

- United Pacific LED "GLO" Light Display
- Multi Functional Control Allows Drivers to See the Lights in Different Modes of Operations
- Available in 1 Set

Item #	Description	Package	Pack
99070	"GLO" Light Display	Boxed	1 Set/Box
99079	"GLO" Light Display - Version 2	Boxed	1 Set/Box



99070



99079

**Headlight Display Stand**

DESCRIPTION

- United Pacific Headlight Display Stand
- Perfect Way to Display United Pacific Headlights
- Allows Drivers to Touch and Feel the Quality of United Pacific Products

Item #	Description	Package	Pack
99045	Headlight Display Stand	Bulk	1 Pc.



**United Pacific LED Key Chain**

DESCRIPTION

- UP LED Key Chain

Item #	Description	Package	Pack
99057	United Pacific LED Key Chain	Bulk	1 Pc.



**Table Top Bin**

- Description
- United Pacific Table Top Bin

Item #	Description	Package	Pack
99051	Table Top Bin	Bulk	1 Pc.



**Dump Bin**

DESCRIPTION

- United Pacific P.O.P. Display
- Dump Bin

Item #	Description	Package	Pack
99050	Dump Bin	Bulk	1 Pc.

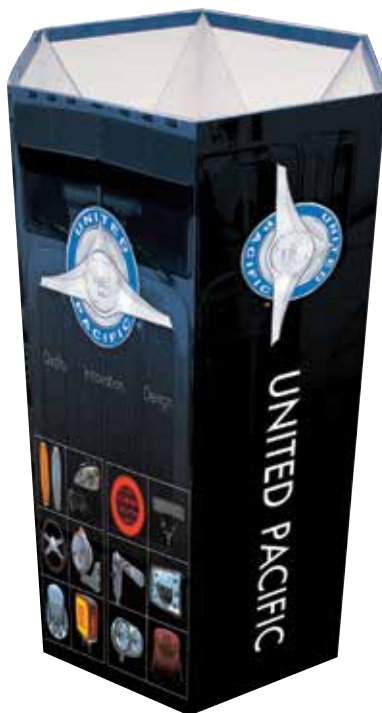

**United Pacific Wall Clock**

DESCRIPTION

- United Pacific Neon Wall Clock
- Available with Blue Neon Light

Item #	Description	Package	Pack
99049	United Pacific Clock	Boxed	1 Pc./Box



Not Lit



Lit

**Spinning Wall Display**

DESCRIPTION

- United Pacific Spinning Wall Display
- Install Anywhere to Show You are an Authorized United Pacific Dealer
- Mounting Holes are 7 3/8" Apart

Item #	Description	Package	Pack
99059	Spinning Wall Display	Bulk	1 Pc.



**United Pacific Gearshift Knob Display**

DESCRIPTION

- United Pacific Gearshift Knob Display
- Gearshift Knobs Sold Separately

Item #	Description	Package	Pack
99072	Gearshift Display	Box	1 Pc.





**United Pacific LED Gearshift Knob Display**

DESCRIPTION

- United Pacific LED Gearshift Knob Display
- Includes 4 LED Gearshift Knobs

Item #	Description	Package	Pack
<b>99101</b>	LED Gearshift Knob Display	Bulk	1 Pc.



**Tire Checker Bat**

DESCRIPTION

- United Pacific 17" Aluminum Tire Checker

Item #	Description	Package	Pack
<b>99060</b>	Tire Checker	Bulk	1 Pc.



**United Pacific Counter Mat**

DESCRIPTION

- Heavy Duty Vynex Counter Mat with 20 of United Pacific's Hottest Products

Item #	Description	Package	Pack
<b>99007</b>	Counter Mat	Bulk	1 Pc.



**8" L Peg Hook for United Pacific Store Display**

DESCRIPTION

- 8" L Peg Hook for United Pacific Store Display

Item #	Description	Package	Pack
<b>99000</b>	8" L Peg Hook	Bulk	1 Pc.



**9" Display Hook Kit**

DESCRIPTION

- Chrome Slatwall Display Hook with Clear Plastic UPC Barcode Holder

Item #	Description	Package	Pack
<b>99002</b>	Display Hook Kit	Bulk	1 Set



**Header/Fixture Sign Bracket**

DESCRIPTION

- Plastic Header/Fixture Bracket
- Perfect for Vertical Mounting

Item #	Description	Package	Pack
<b>99030</b>	Header Bracket	Bulk	1 Pc.



**Header/Fixture Signs**

DESCRIPTION

- United Pacific Header/Fixture Signs
- 48" x 7" Tall, Perfect for Product Identification

Item #	Description	Package	Pack
99032	Peterbilt Header	Bulk	1 Pc.
99033	Kenworth Header	Bulk	1 Pc.
99034	Freightliner Header	Bulk	1 Pc.
99035	International Header	Bulk	1 Pc.
99036	LED Header	Bulk	1 Pc.
99066	Volvo Header	Bulk	1 Pc.



**United Pacific Banner**

DESCRIPTION

- United Pacific Banner

Item #	Description	Package	Pack
99053	48" x 36"	Bulk	1 Pc.



**United Pacific Cap**

DESCRIPTION

- 100% Cotton Twill Cap with Adjustable Size Strap On Back
- Available in 4 Different Styles

Item #	Description	Package	Pack
99099	Flat Bill Cap	Bulk	1 Pc.
99084	USA Flag Cap	Bulk	1 Pc.
99085	Flame Cap	Bulk	1 Pc.
99086	Camo Cap	Bulk	1 Pc.



99099



99084



99085



99086

# REFERENCE

Terms & Conditions.....	136
Warranty Index .....	140
Product Index .....	142

# REFERENCE

# TERMS & CONDITIONS / ORDERING GUIDELINES / FREIGHT

IMPORTANT: PLEASE REVIEW CAREFULLY

## New Accounts

Initial minimum buy-in is \$2,000 (or to be determined by United Pacific Industries, UPI hereafter). All initial orders must be prepaid in advance by Cashier's Check or VISA/MC. All new/potential accounts must complete a UPI "New Customer Info/Credit Form" and follow the Dealer Qualification Instructions. Upon completion of the credit application, approved accounts will be assigned payment terms of NET 30 Days (from invoice date). Accounts denied a credit line will be required to prepay in advance by Cashier's Check or VISA/MC.

## Payment Terms:

### Term Accounts

Accounts with NET 30 Days terms are required to submit payment within the 30 days from the date of invoice. Acceptable forms of payment include checks, ACH (Automated Clearing House), or wire transfer.

A service charge of 1.5% per month will be imposed on invoices not paid within the 30 day term. Delinquent accounts will be required to pay Cash-In- Advance (CIA). Checks will be accepted but orders will not be released until the check is cleared by the bank. Past due invoices will delay current orders. Please check with UPI on your account status when placing an order.

### Credit Cards

Accounts denied credit terms may pay by Visa or MasterCard. Credit card will be charged upon shipment. Credit card payments will not be accepted once an order has been shipped. UPI does not accept American Express or Discover card.

### COD

A \$9.00 fee will be assessed per COD box for all FedEx/UPS COD shipments. Truck COD shipment fees are to be determined later by trucking company.

### Returned Checks:

A \$30 NSF (Non Sufficient Fund) fee will be assessed on each incidence a check is returned to UPI.

## ORDERING GUIDELINES

Placing Orders: New orders may be placed by any of the following methods

1. Fax: [888.986.5988](tel:888.986.5988)
2. E-mail: [sales@upauto.com](mailto:sales@upauto.com)
3. Telephone: In order to minimize errors, customers are encouraged to submit their orders by fax or email. Telephone orders should be limited to smaller orders such as add-ons to orders already submitted and/or fill-ins occurring between larger restocking orders.

## Changes to Orders:

Whenever possible, revisions to orders - additions or deletions of items - should also be submitted via fax or email to reduce the possibility of errors.

Additions/Deletion of items will only be accepted within 48 hours after the initial order date and/or before 12:00PM on the date of the shipment. Additions of items placed after the 48 hours time period will be considered a new order and adhere to a new order freight prepaid policy. Deletions of item cannot happen after the 48 hours time period and/or after 12:00PM on the date of the shipment. Please note additions and/or deletions of items will delay the shipment date.

## Canceling Orders:

Cancellation of orders must be submitted via fax or email within 24 hours of the order date. If the order has already shipped it will be the customers responsibility to return the order at the customers own expense. A restocking fee may apply, please see "Return" policy for further detail.

## Backorders:

Customers have the option of having their backorders shipped or canceled. UPI will notify customer as to availability of backorders and will be able to ship any backorder items customer still needs as part of their next stock order. UPI reserves the right to cancel backorders that are 6 months or older from the initial invoice date.

## Minimum Order:

A minimum order of \$50.00 is required. Orders below \$50.00 will be assessed a minimum order fee of \$10.00.

## Packaging:

A 10% service charge will be added to orders with special packaging or UPC barcoding requirements.

## Lead Times:

Standard lead time for all United Pacific orders is 1-3 business days from the receipt of the purchase order. Larger orders may require a lead time of up to 5 business days. Transit time of 3-5 business days must be considered when placing orders. UPI cannot be responsible for delays in shipment after an order leaves our warehouse. UPI will work to resolve delays with freight forwarding firms, however, delays do arise from time to time due to weather and unforeseen circumstances beyond UPI's control. Express order are exempted; please view Freight/Shipping Policy for further detail.

## Order Confirmation:

United Pacific will acknowledge receipt of orders by email/fax/ telephone within 1 business day of receipt. If confirmation is not received, please contact UPI to ensure your order was received.

## FREIGHT

### Prepaid Freight:

Stock orders between \$50 and \$999.99 (US Lower 48 States), **\$50 and \$2499.99 (Alaska and Hawaii)**, **\$50 and \$1499.99 (Canada)**, [all price net US\$], will be shipped FOB Long Beach, California. Stock orders of \$1,000 (US Lower 48 States), **\$2500 (Alaska and Hawaii)**, **\$1500 (Canada)**, [based on UPI current pricing], or more will be shipped Freight Prepaid Ground to a single location only. (See exception for Oversize Items\*). Express Air orders, Special Net Pricing orders, and Special Quote Pricing orders are excluded. United Pacific reserves the right to select the carrier of our choice. Customers may select the carrier of their choice at their own expense, negotiated rates and insurance. If customers elect to choose their own freight carrier, orders will be shipped via FREIGHT COLLECT.

**Oversize Item Freight Policy** – Applies to 1932 Ford car & truck body shell assemblies, 1932 Ford car & truck body parts such as floor assembly, roof, door, fender, quarter panel, grille, bulk rail gutter, bulk roof tack strip, chassis & frame, wheels & tire, and any exceptionally large or heavy item.

1. Freight will be prepaid by United Pacific if the total order of all items exceeds \$4,000 (US Lower 48 States) or **\$5000 (Hawaii, Alaska and Canada)**, [all price net US\$]. There will not be additional charges for these items included on the order.
2. Freight will be prepaid by United Pacific if a customer orders a total of \$2,500 (US Lower 48 States) or **\$3500 (Hawaii, Alaska and Canada)**, [all price net US\$], of PB 379 fenders, 60" or longer exhaust, and/or 18"+ Longer Saddle Boxes only. If the order is below \$2,500 (US Lower 48 States) or **\$3500 (Hawaii, Alaska and Canada)**, United Pacific will add freight charges to the order for the oversize items.

## Will Call Orders:

Will Call orders can be picked up 2 - 4 hours after placing the order. Customers should always call ahead to confirm when order will be ready to pick up.

# SHIPPING POLICY / CLAIMS

IMPORTANT: PLEASE REVIEW CAREFULLY

## SHIPPING POLICY

### International Shipments:

Shipments to locations outside the continental United States will be shipped to the customer's shipping agent or broker within the continental United States in accordance with the US freight policy. International customers will be responsible for the duties and taxes of their respective country.

### Express Orders:

All express orders, such as Next Day, Second Day, 3 Day Service & Will Call, must be faxed/emailed. Order confirmation will be faxed to the customer for final approval. If confirmation is not received, please contact UPI to ensure your order was received. Customers are required to sign off on express orders and fax confirmation back to UPI. Cut off for express order is 12:00PM. Express orders received after 12:00PM may or may not ship the same day. Please call UPI to confirm projected shipping date or will call time.

Due to the high cost of express shipments, customer may request UPI to call to confirm freight charges. If customer does not request confirmation, UPI will ship the express order.

### Drop Shipments:

All drop shipment orders will be assessed a 5% processing fee. Drop shipment processing fee will be automatically added to the invoice without notice. All drop shipment orders must be faxed in. No freight allowance or prepaid freight will be permitted for any drop shipments, thus, all drop ship orders, regardless of order size, are FOB Long Beach, CA.

## CLAIMS

### General Policy:

All claims (Shortage, Mis-Shipped, Damage, Overage, Customer Error & Billing Error) must be submitted to UPI within 3 business days of the receipt of shipment. Claims submitted beyond 3 business days of the receipt of shipment will be voided by UPI.

On all shipments, the person who signs and receives the shipment is responsible for noting on the Bill of Lading, in writing, whether any boxes arrived damaged or shorted. Failure to do so will void all claim rights between all parties. UPI will have no recourse against the trucking company if customer does not note any damages or shortages on the Bill of Lading.

The customers receiving department must count and sign for the exact number of boxes received. Failure to follow the above instructions will void all claim rights between all parties.

### Shortages / Mis-Ships / Damages

While UPI strives to fill every order with 100% accuracy, on occasion an item may get shipped in error or get damaged during shipping. In the event this occurs, please follow the process below. Note: This type of claim must be reported to UPI within three (3) business days of receiving the order.

1. Contact the United Pacific office to initiate the claim. To make it easy for you we have two acceptable methods for requesting the claim:

- By e-mail : [returns@upauto.com](mailto:returns@upauto.com)
- By fax : [888.986.5988](tel:888.986.5988)

\* **Note: To ensure you receive a timely credit, we cannot accept claim requests by phone.**

2. You will be required to provide the following information:

- Your business name
- Contact name and telephone number (in case we have questions)
- Date the order was received
- A copy of the Packing List / Invoice noting the item number and quantity that was shipped in error or damaged during shipping.
- Special instructions you have for us.

3. UPI will send a return label so you can ship the items back.

4. Once we receive the miss-shipped/damaged item(s) a credit will be issued to your account on the next billing cycle.

5. Shortages will be credit to the Customers' account, unless customer would like the shortages replaced.

### Overages:

UPI strives to provide our customers with the best customer service and products, in turn we would greatly appreciate any help from customer in notifying UPI of any shipping overages. Customers will be offered the option of retaining the merchandise or returning the merchandise to UPI at UPI's expense. If the items are to be returned, an RMA number and return shipping label will be provided.

### Customer Errors:

Any item or quantity ordered in error by the customer may be returned by contacting UPI for a RMA No.

1. To make it easy for you we have two acceptable methods for requesting the RMA:

- By e-mail: [returns@upauto.com](mailto:returns@upauto.com)
- By fax: [888.986.5988](tel:888.986.5988)

\* **Note: To ensure you receive a timely RMA credit, we cannot accept RMA requests by phone.**

2. You will be required to provide the following information.

- \* Your business name
- \* Contact name and telephone number (in case we have questions)
- \* A list of the items number and quantity ordered in error
- \* Special instructions you have for us

3. UPI will review the request to ensure the products are within the return period.

4. Once we have validated the request, United Pacific will issue an RMA number to the customer. In issuing the RMA approval, the following conditions will apply :

- Returned items are subject to a 20% re-stocking fee.
- Return shipping costs are the responsibility of the customer.
- Items must not have any retail/price sticker on exterior packaging or they will be returned to the customer at customer's expense and no credit given.
- Items must be in good condition with original packaging intact or they will be returned to the customer at customer's expense and no credit given.
- Allow up to 30 days for the credit to be issued from the time the returned items are received.

### Billing Errors:

Billing errors should be reported to UPI within 3 business days of invoice receipt. Customers are asked to provide the invoice number, part number, and quantities in question. Once verified, UPI will issue a credit or an invoice for the difference in billing error.

# WARRANTY POLICY / RETURNS

IMPORTANT: PLEASE REVIEW CAREFULLY

## WARRANTY POLICY

### General Policy:

UPI offers a NO HASSLE WARRANTY RETURN policy to all our customers. Warranty claims can only be submitted through an authorized UPI Distributor. UPI warranty is not transferable and applies to the original installation and purchase only. In no event shall UPI be liable for incidental or consequential damages, nor shall UPI be liable for any claims or damages arising out of or connected with the UPI warranty exceed the purchase price of the products. There are no warranties, expressed or implied (including any warranty of merchantability or fitness) that extend beyond this warranty. The warranty does not apply to costs associated with the loss of use of the product, loss of time, inconvenience, commercial loss, incidental or consequential damages. UPI reserves the right to alter the designs of products without assuming any obligation to modify previously manufactured products and will only replace warranted products with redesigned products.

Warranty does not apply to merchandise that has been drilled, cut, welded, modified in any way or installed contrary to normal installation and usage. In addition, UPI cannot be held liable for damages caused by road hazards, accidents, misuse, neglect, abuse or corrosive environments including acid washes and highway snow/ice chemicals which can cause discoloration and corrosion in aluminum, chrome, stainless steel and light products. UPI reserves the right to credit returned merchandise at the initial purchase price or at the current selling price, which price ever is lower.

### Aluminum / Chrome / Stainless Steel Products:

All aluminum, chrome, and stainless steel products carry a limited 6 month warranty (from invoice date) against defects in material or workmanship.

### Lighting Products:

#### Incandescent

All incandescent lighting products carry a limited 12 month warranty (from invoice date) against defects in material or workmanship. The limited 12 month warranty does not apply to several applications, such as, buses, construction equipment, and off road vehicles.

#### LED

All LED lighting products carry a specific Limited Warranty (from invoice date) against defects in material or workmanship.

- LED with vehicle specific application is limited lifetime warranty to an original purchaser with receipt. Examples of lifetime warranty product: CTL5720LED CTL5720LED for 1957 Chevy, FTL3201LED-L for 1932 Ford.
- LED Marker, 2", 2-1/2", 4", 7", Oval & Square Lights - Varies from 2 years to 10 years to Limited Lifetime, depending on specific item. The housing, bezel or mounting base on any light made from Chrome/Stainless carries a 6 month limited warranty.
- LED Cab Lights and Kits, Double/Single Stud Turn Signal and PB/KW/FL/VL or non-make Turn Signals and any/all Strip Lights - Varies from 2 years to 10 years to Limited Lifetime, depending on specific item. The housing, bezel or mounting base on any light made from Chrome/Stainless carries a 6 month limited warranty.
- LED Beacon, Driving, Headlights, Work & Warning Lights - Varies from 6 months to 3 years. The housing, bezel or mounting base on any light made from Chrome/Stainless carries a 6 month limited warranty.
- All LED Accessory Lights (Honda, Stainless Steel Double/Single face Lights, Interior Lights, License Plate Lights, and any Accent Lights. The housing, bezel or mounting base on any light made from Chrome/Stainless carries a 6 month limited warranty.

## RETURNS

### General Policy:

All returns must be authorized by UPI. All return requests must be faxed or e-mailed ([returns@upauto.com](mailto:returns@upauto.com)) A RMA number (Return Merchandise Authorization Number) will be provided. Returns not possessing a valid RMA number are subject to rejection and will be returned to sender at the customer's expense.

All customers are encouraged to use the Warranty RMA Claim Form.

### Defective Goods / Warranty Return:

UPI offers our customers a No Hassle Warranty Return. Please follow the instructions below for requesting a RMA for defective goods:

1. If any warranty issues occur, simply contact the UPI for RMA number To make it easy for you we have two acceptable methods for requesting the RMA:
  - By e-mail: [returns@upauto.com](mailto:returns@upauto.com)
  - By fax: **888.986.5988**
  - **Note: To ensure you receive a timely RMA credit, we cannot accept RMA requests by phone.**
2. You will be required to provide the following information:
  - Your business name
  - Contact name and telephone number (in case we have questions)
  - A list of the defective item number and quantity with the nature/ reason of the defect
  - Special instructions you have for us
  - The enclosed fax form may be used for your convenience to request an RMA
3. UPI will review the request to ensure the products are within the stated warranty period.
4. Once we have validated the warranty items, a RMA confirmation, listing the items and cost will be faxed to the customer within 3 business days. UPI will process the credit to your account within 30 days.

**Note: There will be no need to return the warranty product to us. However, from time to time, UPI may require some warranty products to be shipped back so we may analyze the cause of the failure. All warranty products that are required to be shipped back will be freight prepaid by UPI.**

### Stock Return

United Pacific Industries encourages all customers to regularly monitor the sales volume and stock level of their inventory items. As sales trends may slow the movement of specific items, our hope is that those items are featured as "close-out specials" as to minimize stock returns. We also understand that the customer, from time to time, may accumulate over-stock items and desire to return those. Therefore, we have adopted the following policy below.

#### NOTE:

- Items must have been purchased by the dealer requesting the stock return.
- Items must have been purchased within the preceding 12 months.
- Items that have been discontinued will not be considered for return.

1. Contact the United Pacific office for RMA number We have 2 acceptable methods for requesting the RMA:

By e-mail : [returns@upauto.com](mailto:returns@upauto.com)

By fax : **888.986.5988**

**\*Note: To ensure you receive a timely RMA credit, we cannot accept RMA requests by phone.**

# RETURNS / CATALOGS / DISCLAIMER

IMPORTANT: PLEASE REVIEW CAREFULLY

2. You will be required to provide the following information:

- Your business name
- Contact name and telephone number (in case we have questions)
- A list of defective items: Item numbers and quantity of each
- Special instructions you have for us

3. Your claim will be reviewed within 5 business days and you will be contacted by your sales representative who will discuss solutions to liquidate these slow moving items.

4. In the event United Pacific and the customer agree to a credit in lieu of returning the items, this credit will be issued within 10 business days.

5. In the event items are returned by the customer, United Pacific will issue an RMA number to the customer. In issuing the RMA approval, the following conditions will apply:

- Returned items are subject to a 20% re-stocking fee.
- Return shipping costs are the responsibility of the customer.
- Items must not have any retail/price sticker on exterior packaging or they will be returned to the customer at customer's expense and no credit given.
- Items must be in good condition with original packaging intact or they will be returned to the customer at customer's expense and no credit given.
- Allow up to 30 days for the credit to be issued from the time the returned items are received.

6. Stock returns may be requested throughout the year and are subject to a maximum of 5% of prior year annual purchases.

### Closeout/Discontinue Items:

UPI will not warranty or accept returns on Closeout/Discontinue items.

### Procedure:

An inventory of the merchandise being returned must accompany each return. The RMA number should be prominently displayed on each carton/box.

All Returns must be returned freight prepaid.

### Ship Returns to:

United Pacific Industries  
Attn: Returns Department  
3788 E. Conant St.  
Long Beach, CA 90808

### RMA's:

Outstanding RMA's will be automatically canceled if not used within 30 days of issuance.

## CATALOGS

### General Policy:

UPI will send a set of catalogs and price lists upon the arrival any new catalogs and price list. Included in the mailing will be a Catalog Order Form in which customers can request additional copies.

### Catalog/CD Request:

UPI provides additional catalogs/CD's to our customers free of charge. Customer must submit their request on a UPI Catalog Order Form or add the request to their regular restocking order. Requests for additional catalogs/CD's should be submitted along with the regular restocking orders to avoid additional freight charges. Due to the availability of catalogs/CD's, customer's request may be limited to certain quantity. Catalogs/CD's will be shipped along with the customers' order. Customer may request the catalogs be shipped separately, but customer will be responsible for the freight charge.

### Picture Request

All UPI item pictures are taken professionally by our marketing department. Item pictures can be downloaded online at [www.upauto.com](http://www.upauto.com). Item pictures not posted online can be requested by sending an email to e-mail [graphic@upauto.com](mailto:graphic@upauto.com). All picture requests must state the item no and the format of the picture file, i.e jpeg or high resolution. UPI has over 20,000 SKU's and therefore does not have a CD with all the items.

## DISCLAIMER

United Pacific Industries reserves the right to amend or update our Policies & Procedures without notice.

United Pacific Industries is not responsible for typographical, product information or print errors. Specifications on this catalog may be changed without advance notice. Products may look different from those in the photos on this catalog due to printing quality.

## RMA FORM SAMPLE



UNITED PACIFIC INDUSTRIES, INC.  
3788 E. CONANT ST.  
LONG BEACH, CA 90808  
DIRECT: (562) 421-3888  
TOLL FREE: (800) 790-6988  
TOLL FREE FAX: (888) 986-9888

### DEFECTIVE GOODS / WARRANTY CLAIM FORM

Date: \_\_\_\_\_  
Company Name: \_\_\_\_\_  
Address: \_\_\_\_\_  
City, State, Zip: \_\_\_\_\_  
Contact Name: \_\_\_\_\_  
Phone Number: \_\_\_\_\_  
Fax Number: \_\_\_\_\_  
E-mail: \_\_\_\_\_

List defective items below:

Item #	Quantity	Description	Reason for Defect	Date sold to Customer
1				
2				
3				
4				
5				
6				
7				
8				
9				
10				

Any special notes / instructions for United Pacific (list here):

File your claim at:  
by email - [returns@upauto.com](mailto:returns@upauto.com)  
by fax - (888) 986-9888

Note: we cannot accept any phone request

Internal Use Only	
Date Received: _____	Final RMA: _____
RMA Approval Date: _____	Credit Amount: _____
RMA Number: _____	Approved By: _____







# 6 MONTH LED LIMITED WARRANTY

United Pacific Industries extend a Limited 6 Month Warranty to the original purchaser that United Pacific LED lights are free from defects in workmanship and/or materials only. United Pacific Industries will only replace the LED lights to the original consumer/purchaser if the light fails due to defects in workmanship and/or material only. The Limited 6 Month Warranty does not apply to severe applications, such as, buses, construction equipment, and off road vehicles. These applications are example only and are not inclusive of all excluded applications. The use of chemicals, cleaners, and/or solvents that are incompatible with polycarbonate will result in softening, crazing, and/or cracking of the light. United Pacific Industries' 6 Month Limited Warranty does not extend to damages associated with incompatible chemicals, cleaners, and/or solvents. The Limited 6 Month Warranty does not apply to merchandise that has been drilled, cut, welded, modified in any way, or installed contrary to normal installation and

usage. Any violation of these conditions will void this 6 Month warranty. The 6 Month Limited Warranty is not transferable and applies to the original installation only. In no event shall United Pacific Industries be liable for incidental or consequential damages, nor shall United Pacific Industries' liability for any claims or damages arising out of or connected with the 6 Month Limited Warranty exceed the purchase price of products. There are no warranties, expressed or implied (including any warranty of merchantability or fitness) that extend beyond this warranty. The warranty does not apply to costs associated with the loss of use of the product, loss of time, inconvenience, commercial loss, incidental or consequential damages. United Pacific Industries reserve the right to alter the designs of products without assuming any obligation to modify previously manufactured products and will only replace warranted products with redesigned products.

Item No.	Item No.	Item No.	Item No.	Item No.
10862	38345	38874		
10863	38346	38877		
10864	38347	38931		
10867	38348	38935		
37800	38530	38936		
37801	38531	38983		
37802	38532	38984		
37803	38534	38986		
37804B	38535	38990		
37805B	38543	38991		
37806B	38546	38994		
37807B	38554	39314B		
37955	38555	39315B		
37956	38558	39316B		
37958	38559	39317B		
38008	38563	39318B		
38038	38565	39319B		
38042	38566	39381		
38043	38567	39382		
38044	38568	39384		
38045	38570	39385		
38047	38571	39644B		
38048	38572	39645B		
38049	38573	39712		
38053	38574	39715		
38056	38576	39716		
38202	38577	39862		
38203	38582	39863		
38209	38584	39864		
38210	38589	39865		
38211	38594	39866		
38251	38686	39867		
38261	38687	39887		
38262	38690	39889		
38263	38691	39890		
38264	38760	39891		
38265	38765	39892		
38266	38788	70300		
38273	38790	70301		
38274	38791	70302		
38276	38866	70303		
38277	38867			
38332	38868			
38341	38870			
38343	38872			
38344	38873			

# PRODUCT INDEX

ITEM#	PAGE#	ITEM#	PAGE#	ITEM#	PAGE#	ITEM#	PAGE#	ITEM#	PAGE#
10305	40, 93	20834	6	21026-1S	19	21693	103	21776B	101
10862	121	20835	6	21027	18	21693B	103	21777	101
10863	121	20836	6	21028	18	21701	102	21777B	101
10864	121	20837	6	21029	18	21702	102	21778	101
10867	121	20838	6	21030	18	21703	102	21778B	101
10948	69	20839	6	21031	18	21704	102	21779	101
10958	91	20840	6	21044	18	21705	102	21779B	101
10960	91	20841	6	21044-1B	19	21706	103	21780	101
20507	5	21002	14	21044-1G	19	21707	103	21780B	101
20511	5	21002P	14	21044-1K	19	21708	64	21781	101
20513	5	21005	12	21044-1P	19	21713	102	21781B	101
20514	5	21005B	12	21044-1R	19	21727	88	21782	101
20528	5	21008	14	21044-1S	19	21728	49	21782B	101
20529	5	21010	18	21045	18	21751	103	21783	101
20533	5	21010-1	19	21046	18	21752	103	21783B	101
20538	5	21010-1B	19	21047	18	21753	103	21784	101
20539	5	21010-1G	19	21048	18	21754	103	21784B	101
20541	5	21010-1K	19	21049	18	21755	103	21785	101
20542	5	21010-1P	19	21053	44	21756	103	21785B	101
20550	5	21010-1R	19	21054	44	21758	103	21786	101
20551	5	21010-1S	19	21055	44	21758B	103	21786B	101
20554	5	21011	18	21058	64	21759	103	21787	101
20555	5	21012	18	21059	64	21760	103	21788	101
20560	5	21013	18	21070	18	21761	103	21788B	101
20561	5	21014	18	21070-1B	19	21762	103	21789	101
20596	44	21015	18	21070-1G	19	21762B	103	21789B	101
20600	88	21016	65	21070-1K	19	21763	103	21790	101
20814	6	21017	65	21070-1P	19	21763B	103	21790B	101
20815	6	21019	65	21070-1R	19	21765	103	21791	101
20816	6	21020	18	21070-1S	19	21765B	103	21791B	101
20817	6	21020-1B	19	21071	18	21766	103	21792	70
20818	6	21020-1G	19	21072	18	21767	103	21793	69, 70
20819	6	21020-1K	19	21073	18	21768	103	21794	70
20820	6	21020-1P	19	21074	18	21769	103	21795	70
20821	6	21020-1R	19	21075	18	21769B	103	21796	69, 70
20822	6	21020-1S	19	21080	65	21770	103	21797	70
20823	6	21021	18	21081	65	21771	101	21798	70
20824	6	21022	18	21082	65	21771B	101	21799	70
20825	6	21023	18	21083	65	21772	101	21802	53
20826	6	21024	18	21084	65	21772B	101	21909	95
20827	6	21025	18	21085	65	21773	101	21910	69
20828	6	21026	18	21086	65	21773B	101	21911	69
20829	6	21026-1B	19	21527	91	21774	101	21912	69
20830	6	21026-1G	19	21691	103	21774B	101	21913	69
20831	6	21026-1K	19	21691B	103	21775	101	21914	69
20832	6	21026-1P	19	21692	103	21775B	101	21915	69
20833	6	21026-1R	19	21692B	103	21776	101	21916	69

ITEM#	PAGE#	ITEM#	PAGE#	ITEM#	PAGE#	ITEM#	PAGE#	ITEM#	PAGE#
22960	27	23030-2S	27	23060-2G	53	23165	52	23215-2P	26
22961	27	23030-3B	27	23060-2K	53	23166	31	23215-2R	26
22962	27	23030-3G	27	23060-2P	53	23167	31	23215-2S	26
22963	27	23030-3K	27	23060-2R	53	23168	31	23216	23
22996	49	23030-3P	27	23060-2S	53	23169	31	23218	23
22997	49	23030-3R	27	23061	52	23170	31	23219	23
23000	49	23030-3S	27	23062	52	23172	31	23220	23
23008B	28	23030-4B	27	23063	52	23173	31	23222	33
23010	33	23030-4G	27	23064	52	23174	31	23222-1B	39
23010-1	32	23030-4K	27	23065	52	23175	31	23222-1G	39
23010-1P	32	23030-4P	27	23066	29	23176	31	23222-1K	39
23010-2B	40	23030-4R	27	23067	29	23178	36	23222-1P	39
23010-2G	40	23030-4S	27	23068	29	23179	36	23222-1R	39
23010-2K	40	23030-5B	27	23069	29	23181	38	23222-1S	39
23010-2P	40	23030-5G	27	23078-1	67	23182	38	23222-2B	39
23010-2R	40	23030-5K	27	23090	29	23201	23	23222-2G	39
23010-2S	40	23030-5P	27	23091	29	23201-1B	26	23222-2K	39
23010-3B	40	23030-5R	27	23093-1	66	23201-1G	26	23222-2P	39
23010-3G	40	23030-5S	27	23136	21	23201-1K	26	23222-2R	39
23010-3K	40	23030-8B	27	23137	21	23201-1P	26	23223	33
23010-3P	40	23030-8G	27	23138	21	23201-1R	26	23224	33
23010-3R	40	23030-8K	27	23139	21	23201-1S	26	23225	33
23010-3S	40	23030-8P	27	23140	21	23202	23	23226	33
23010-4B	40	23030-8R	27	23141	21	23203	23	23227	33
23010-4G	40	23030-8S	27	23142	21	23204	23	23229	33
23010-4K	40	23031	24	23143	21	23205	23	23229-1B	39
23010-4P	40	23032	24	23144	21	23206	23	23229-1G	39
23010-4R	40	23033	24	23145	21	23208	23	23229-1K	39
23010-4S	40	23034	24	23146	21	23208-1B	26	23229-1P	39
23011	33	23035	24	23147	21	23208-1G	26	23229-1R	39
23012	33	23036	24	23148	21	23208-1K	26	23229-1S	39
23013	33	23037	24	23149	21	23208-1P	26	23229-2B	39
23014	33	23038	24	23150	21	23208-1R	26	23229-2G	39
23015	33	23039	24	23151	21	23208-1S	26	23229-2K	39
23016	29	23040	24	23152	21	23208-2B	26	23229-2P	39
23017	33	23041	24	23153	21	23208-2G	26	23229-2R	39
23018	33	23042	24	23154	21	23208-2K	26	23230	33
23019	33	23043	24	23155	21	23208-2P	26	23231	33
23020	33	23044	24	23156	21	23208-2R	26	23232	33
23021	33	23045	24	23157	21	23208-2S	26	23233	33
23022	33	23046	24	23158	21	23209	23	23234	33
23024	33	23047	24	23159	21	23210	23	23236	33
23025	33	23048	24	23160-1B	53	23211	23	23236-1B	39
23026	33	23049	24	23160-1P	53	23212	23	23236-1G	39
23027	33	23050	24	23160-1R	53	23213	23	23236-1K	39
23028	33	23051	24	23160-1S	53	23215	23	23236-1P	39
23029	33	23052	24	23160-2B	53	23215-1B	26	23236-1R	39
23030	24	23053	24	23160-2G	53	23215-1G	26	23237	33
23030-1	23	23054	28	23160-2K	53	23215-1K	26	23238	33
23030-1P	23	23057	30	23160-2P	53	23215-1P	26	23239	33
23030-2B	27	23058	28	23160-2R	53	23215-1R	26	23240	33
23030-2G	27	23059	50	23160-2S	53	23215-1S	26	23243	23
23030-2K	27	23060	52	23161	52	23215-2B	26	23243-1B	26
23030-2P	27	23060-1P	52	23163	52	23215-2G	26	23243-1G	26
23030-2R	27	23060-2B	53	23164	52	23215-2K	26	23243-1K	26

ITEM#	PAGE#	ITEM#	PAGE#	ITEM#	PAGE#	ITEM#	PAGE#	ITEM#	PAGE#
23243-1P	26	23292	37	23358-3	38	23419	32	23474	22
23243-1R	26	23293	37	23359	38	23420	32	23475	22
23243-1S	26	23296	37	23360	34	23421	32	23476	22
23244	23	23297	37	23364	33	23422	32	23477	22
23245	23	23298	37	23364-1	40	23423	32	23478	22
23246	23	23299	37	23364-2	40	23424	32	23479	22
23247	23	23300	37	23365	33	23425	32	23480	22
23248	23	23301	37	23370B	30	23426	32	23481	22
23249	23	23304	37	23377	21	23427	32	23482	22
23249-1B	26	23305	37	23378	26	23428	32	23483	22
23249-1G	26	23306	37	23378-1	24	23429	32	23484	22
23249-1K	26	23307	37	23378-1P	24	23430	32	23485	22
23249-1P	26	23308	37	23378-3	27	23431	32	23486	22
23249-1R	26	23309	37	23378-4	27	23432	32	23487	22
23249-1S	26	23310	36	23378-5	27	23433	32	23488	22
23249-2B	26	23310-1	35	23378-6	27	23434	32	23489	22
23249-2G	26	23310-1P	35	23378-7	27	23435	32	23490	22
23249-2K	26	23311	36	23378-8	53	23436	22	23492	22
23249-2P	26	23312	36	23379	26	23437	22	23493	22
23249-2R	26	23313	36	23380	26	23438	22	23494	22
23249-2S	26	23314	36	23381	26	23439	22	23495	22
23250	23	23315	36	23384	26	23440	22	23500	52
23251	23	23318	36	23385	31	23441	22	23501	52
23252	23	23319	36	23385B	31	23442	22	23502	52
23253	23	23320	36	23386	32	23443	22	23503	52
23254	23	23321	36	23387	32	23444	22	23504	52
23255	24	23322	36	23389	30	23445	22	23505	52
23256	24	23323	36	23390	21	23446	22	23508	29
23257	24	23326	36	23390B	21	23447	22	23509	29
23258	24	23327	36	23391	22	23448	22	23510	30
23259	24	23328	36	23392	22	23449	22	23511	30
23260	24	23329	36	23393	22	23450	22	23512	30
23264	38	23330	36	23394	22	23451	22	23513	30
23264-1	37	23331	36	23395	22	23452	22	23514	30
23265	38	23334	36	23396	22	23453	22	23515	30
23266	38	23335	36	23398	21	23454	22	23516	30
23267	38	23336	36	23399	30	23455	22	23517	30
23268	38	23337	36	23400	31	23456	22	23518	30
23269	38	23338	36	23401	31	23457	22	23519	30
23272	38	23339	36	23402	31	23458	22	23520	30
23273	38	23342	36	23403	31	23459	22	23521	30
23274	38	23343	36	23404	31	23460	22	23522	40
23275	38	23344	36	23405	31	23461	22	23523	40
23276	38	23345	36	23406	31	23462	22	23525	28
23277	38	23346	36	23407	31	23463	22	23526	29
23280	38	23347	36	23408	31	23464	22	23527	29
23281	38	23350	36	23409	31	23465	22	23528	29
23282	38	23351	36	23410	31	23466	22	23529	28
23283	38	23352	36	23411	31	23467	22	23530	24
23284	38	23353	36	23412	31	23468	22	23532	24
23285	38	23354	36	23413	31	23469	22	23533	24
23288	37	23358	38	23414	31	23470	22	23534	24
23289	37	23358-1	38	23415	31	23471	22	23535	24
23290	37	23358-1P	38	23416	31	23472	22	23536	25
23291	37	23358-2	38	23418	32	23473	22	23537	25

ITEM#	PAGE#	ITEM#	PAGE#	ITEM#	PAGE#	ITEM#	PAGE#	ITEM#	PAGE#
23538	25	23594	25	23650	24	23735	34	23919	20
23539	25	23595	25	23651	24	23736	34	24001	89
23540	25	23596	25	23652	24	23737	34	24009	90
23541	25	23597	25	23653	24	23738	34	24010	90
23542	25	23598	25	23654	32	23739	34	24011	90
23543	25	23599	25	23655	32	23740	34	24015	90
23545	25	23600	25	23656	32	23742	35	24016	90
23546	25	23601	25	23657	32	23743	35	24017	90
23547	25	23602	25	23658	32	23744	35	24018	90
23548	25	23603	25	23660	32	23745	35	24019	90
23549	25	23604	25	23661	32	23746	35	24020	90
23550	25	23605	25	23662	32	23747	35	24021	90
23551	25	23606	23	23663	32	23748	35	24022	90
23552	25	23607	23	23664	32	23749	35	24023	90
23553	25	23608	23	23669	35	23750	35	24024	90
23554	25	23609	23	23670	35	23751	35	24025	90
23555	25	23610	23	23671	35	23752	35	24026	90
23556	25	23611	23	23672	35	23753	35	24027	90
23557	25	23612	23	23673	35	23754	35	24028	90
23558	25	23613	23	23675	35	23755	35	24031	89
23559	25	23614	23	23676	35	23756	35	24032	89
23560	25	23615	23	23677	35	23757	35	24033	89
23561	25	23616	23	23678	35	23758	35	24034	89
23562	25	23617	23	23679	35	23759	35	24035	89
23563	25	23618	23	23681	37	23760	35	24036	89
23564	25	23619	23	23682	37	23761	35	24039	91
23565	25	23620	23	23683	37	23837	20	24052	20
23566	25	23622	23	23684	37	23837P	20	24052B	20
23567	25	23623	23	23685	37	23839	20	24053	20
23568	25	23624	23	23687	37	23839B	20	24053B	20
23569	25	23625	23	23688	37	23840	20	24054	20
23570	25	23626	23	23689	37	23840B	20	24054B	20
23571	25	23627	23	23690	37	23841	20	24055	20
23572	25	23628	23	23691	37	23841B	20	24055B	20
23573	25	23629	23	23712	34	23842	20	24056	20
23574	25	23630	24	23713	34	23842B	20	24056B	20
23575	25	23631	24	23714	34	23843	20	28133	96
23576	25	23632	24	23715	34	23843B	20	28134	96
23577	25	23633	24	23716	34	23856	20	28135	96
23578	28	23634	24	23718	34	23856B	20	28471	51
23579	28	23635	24	23719	34	23905	45	28472	51
23581	21	23636	24	23720	34	23906	45	28473	51
23581B	21	23637	24	23721	34	23907	45	28474	51
23582	21	23638	24	23722	34	23908	45	28475	51
23583	21	23639	24	23724	34	23909	45	28476	51
23584	21	23640	24	23725	34	23910	45	28478	50
23585	21	23641	24	23726	34	23911	45	28479	50
23586	21	23642	24	23727	34	23912	45	28480	50
23587	21	23643	24	23728	34	23913	20	28481	50
23588	25	23644	24	23729	34	23913B	20	28482	50
23589	25	23645	24	23730	34	23914	20	28483	50
23590	25	23646	24	23731	34	23915	20	28484	50
23591	25	23647	24	23732	34	23916	20	28485	51
23592	25	23648	24	23733	34	23917	20	28487	51
23593	25	23649	24	23734	34	23918	20	28489	51

ITEM#	PAGE#	ITEM#	PAGE#	ITEM#	PAGE#	ITEM#	PAGE#	ITEM#	PAGE#
28490	51	37602B	115	38211	109	38874	119	40180	92
28491	51	37605B	115	38261	110	38877	119	40182	13
28492	51	37614B	115	38262	110	38931	114	40183	13
28493	51	37615B	115	38263	110	38936	114	40184	13
28495	51	37623	116	38264	110	38983	112	40185	13
28496	51	37624	116	38265	110	38984	112	40186	13
28497	51	37625B	114	38266	110	38986	112	40187	13
28498	52	37626B	114	38272	110	38990	111	40188	13
30805	99	37641	117	38273	110	38994	111	40199	92
30806	99	37642	117	38274	110	39314	121	40200	92
30808	99	37643	117	38276	110	39314B	121	40201	92
30809	99	37644	117	38277	110	39315	121	40202	92
30818	98	37655	116	38332	110	39315B	121	40204	92
30819	98	37656	116	38341	109	39316	121	40205	92
30820	98	37657	116	38343	111	39316B	121	40622	7
30821	98	37658	116	38344	111	39317	121	40623	7
30822	98	37659	116	38345	111	39317B	121	40624	7
30825	98	37660	116	38346	111	39318	121	40625	7
30826	98	37686	108	38347	111	39318B	121	40626	7
30827	98	37687	108	38348	111	39319	121	40627	7
30830	98	37688	108	38448	45	39319B	121	40628	7
30833	98	37690	107	38449	45	39483B	115	40629	7
30835	98	37691	107	38531	112	39484B	115	40630	7
30837	99	37692	107	38532	112	39485B	115	40631	7
30839	99	37693	107	38534	112	39644B	115	40632	7
30841	99	37694	117	38535	112	39645B	115	40633	7
30843	99	37696	117	38543	122	39698	115	40634	7
30844	99	37698	117	38546	122	39699	115	40635	7
30852	98	37734	110	38554	120	39712	119	40665	7
30853	98	37735	110	38555	120	39715	119	40666	7
30854	98	37736	110	38558	120	39804	115	40667	7
30855	98	37737	110	38559	120	39805	115	40668	7
30856	98	37800	110	38563	111	39806	115	40669	7
36543	109	37801	110	38565	111	39862	107	40670	7
36545	109	37802	110	38566	111	39863	107	40671	7
36546	109	37803	110	38567	111	39864	107	40672	7
36547	109	37804B	122	38568	111	39865	108	40673	7
36549	109	37805B	122	38570	111	39866	108	40674	7
36550	109	37806B	122	38571	111	39867	108	40675	7
36905	118	37807B	122	38572	112	40037	13	40676	7
36906	118	37899B	115	38573	112	40037P	13	40677	7
36907	118	37954	116	38576	112	40038	13	40851	99
36908	118	37955	116	38577	112	40038P	13	40880	88
36917	109	37957	116	38686	120	40039	13	40881	88
36920	109	38008	120	38687	120	40039P	13	40882	88
36928	108	38042	118	38690	120	40041	13	40893	14
36930	108	38043	118	38691	120	40041P	13	40914	97
36931	108	38044	118	38760	120	40042	13	40927	105
36932	107	38045	118	38788	107	40042P	13	40928	105
36934	107	38047	118	38790	108	40043	13	40929	105
36935	107	38048	118	38791	108	40043P	13	40936	105
37077	45	38049	118	38866	119	40058	13	40937	105
37078	45	38056	118	38870	119	40158	13	40938	105
37244	116	38209	109	38872	119	40158P	13	40939	105
37246	116	38210	109	38873	119	40164	13	40942	9

ITEM#	PAGE#	ITEM#	PAGE#	ITEM#	PAGE#	ITEM#	PAGE#	ITEM#	PAGE#
40943	9	41110	41	41913	16, 87	41987	97	42096	63
40944	9	41111	41	41915	10	41988	97	42097	87
40958	12, 14	41114	87	41917	10	41990	11	42098	89
40988	105	41129	11	41919	10	41991	11	42099	89
40989	105	41140	16, 88	41921	10	41992	11	42301	10
40990	50	41140B	16	41922	96	41993	11	42309	83
40991	50	41141	16	41923	96	41994	11	42310	95
40992	12	41142	16, 88	41925	96	41995	11	42329	95, 104
40993	43	41143	16, 88	41926	96	41996	11	42330	4
40995	11	41144	16, 88	41927	96	41998	97	42333	5
40996	12	41145	16, 88	41928	96	42020	42	42334	4
41001	12, 14	41146	16, 88	41929	96	42021	42	42335	4
41006	12	41147	15	41930	96	42022	42	42336	4
41021	83	41147B	15	41931	96	42023	42	42337	42
41023	41	41152	43	41933	96	42024	42	42343	95
41024	41	41153	43	41934	96	42025	42	42344	95
41025	41	41155	43	41935	96	42026	42	42349	15
41028	66	41156	43	41936	96	42027	42	42350	15
41029	66	41170	42	41937	96	42030	43	42371	5
41030	66	41171	42	41938	17	42031	43	42372	8
41031	66	41172	42	41939	17	42032	43	42384	89
41032	66	41173	42	41940	49	42033	43	42385	89
41033	66	41174	42	41942	87	42034	43	42386	89
41034	66	41175	42	41943	87	42035	43	42387	89
41035	66	41176	42	41944	87	42037	63	42417	15
41036	66	41189	104	41948	17	42038	16	45975	85
41037	66	41201	105	41950	41	42039	16	45976	85
41038	66	41202	104	41951	9	42040	16	45977	85
41039	66	41203	104	41952	9	42041	16	45978	85
41040	66	41204	104	41953	9	42042	16	45979	85
41041	65	41205	104	41954	9	42043	16	45980	85
41042	65	41206	104	41955	9	42044	16	45981	85
41043	65	41207	104	41956	9	42045	16	45982	85
41044	65	41208	104	41957	9	42047	16	45983	85
41045	65	41264	12	41958	9	42048	16	45984	85
41046	65	41265	12	41959	87	42050	16	45985	85
41047	65	41266	12	41960	87	42051	16	45986	85
41048	67	41267	12	41965	8	42052	16	45987	85
41049	67	41268	12	41966	41	42053	16	45988	85
41050	67	41269	12	41968	41	42054	16	45989	85
41051	67	41270	12	41971	41	42055	16	45990	85
41052	67	41271	12	41972	41	42056	63	45991	85
41053	67	41272	12	41973	17	42059	11	45992	85
41054	67	41900	63	41974	11	42063	97	46105B	85
41061	66	41901	47	41975	87	42064	42	46106	84
41069	83	41902	47	41976	87	42065	64	46111	84
41070	66	41903	48	41977	9	42066	17	46111-1	84
41074	15	41904	48	41978	9	42067	41	46111-2	84
41074B	15	41905	48	41980	9	42068	7	46112	84
41077	44	41906	95	41981	9	42083	97	46112-1	84
41078	43	41907	47	41982	9	42084	88	48058	15
41087	125	41909	95	41983	97	42085	88	48059	15
41088	125	41910	95	41984	97	42091	41	48060	15
41090	43	41911	11	41985	97	42092	41	48061	15
41091	42	41912	11	41986	97	42095	87	48063	15

ITEM#	PAGE#	ITEM#	PAGE#	ITEM#	PAGE#	ITEM#	PAGE#	ITEM#	PAGE#
48066	15	50105	124	70044	93	70300	121	70642	77
48068	15	50106	124	70048	93	70301	121	70644B	28, 80
48070	15	50110	125	70049	92	70302	121	70645B	28, 80
48072	15	50111	125	70084	92	70303	121	70646	80
48079	15	50112	124	70086	92	70361	69	70647	75
48080	15	50119	125	70088	92	70385	127	70648	75
48081	15	50150	126	70095	93	70388	127	70649	74
48082	8	50151	126	70101	61	70389	127	70650	74
48083	8	50152	126	70106	62	70390	127	70651	80
48084	8	50153	126	70108	62	70392	127	70652	81
48085	8	50154	126	70109	62	70405	61	70653	81
48085-1	8	50155	126	70111	60	70406	61	70654	78
48086	8	50156	126	70112	60	70407	61	70655	76
48087	8	50157	126	70113	62	70408	61	70656	80
48088	8	50158	126	70118	61	70409	61	70657	80
48089	8	50159	126	70119	61	70587	74	70658	81
48090	8	50160	126	70120	61	70588	75	70659	80
48091	8	50161	126	70143	127	70590	77	70660	82
48092	8	50162	126	70144	127	70591	83	70661	82
48093	8	50163	126	70145	127	70597	83	70662	82
48094	8	50164	126	70146	127	70598	77	70663	82
48095	8	50165	126	70147	127	70599	77	70664B	72
48096	8	50166	126	70148	127	70600B	75	70665B	73
48097	8	50167	126	70149	127	70601B	28, 80	70666	80
48098	8	50168	126	70151	92	70602B	28, 80	70667	76
48099	8	50169	126	70169	71	70603B	76	70668	76
48102	63	50170	126	70173	71	70604B	74	70669	77
48103	64	50171	126	70174	71	70605	82	70670	79
48111	89	50172	126	70175	71	70606B	82	70671	79
48119	50	50173	126	70176	71	70607	75	70672	80
48120	8	50174	126	70176-1	71	70608	75	70673	80
48121	8	50175	126	70176-2	71	70609	74	70674	81
48122	8	50176	126	70177	71	70610	74	70677	82
48123	8	50177	126	70178	71, 83	70612	78	70679	82
48124	8	50178	126	70195	97	70615	78	70683	76
48126	8	50179	126	70195B	97	70616	78	70684	76
48127	50	50180	126	70196	92	70617	78	70685	79
48128	50	50181	126	70197	92	70618	78	70686	79
48129	8	50182	126	70204	129	70620	79	70687	79
48130	8	50183	126	70209	92	70621B	28, 80	70688	79
48131	8	50184	126	70210	92	70622B	28, 80	70689	79
48132	8	50185	126	70211	92	70623	75	70690	81
48301	43	70013	83	70212	92	70624	74	70691	28, 80
48302	43	70014	83	70213	92	70626	80	70692	76
48500	17	70015	83	70214	92	70627	75	70693	76
48501	17	70016	83	70215	92	70628	74	70694	76
48502	17	70023	93	70228	71	70629B	81	70695	78
48503	17	70025	82	70229	71	70630B	81	70696	78
48504	17	70029	93	70251	92	70635B	79	70697	80
48510	11	70035	93	70259	69	70636	76	70700	128
50100	125	70039	93	70265	70	70637	78	70709	77
50101	125	70040	92	70270	70	70638	79	70710	77
50102	124	70041	92	70273	70	70639	79	70711	80
50103	124	70042	92	70292	69	70640	79	70712	72
50104	124	70043	92	70293	69	70641	79	70713	72



ITEM#	PAGE#	ITEM#	PAGE#	ITEM#	PAGE#	ITEM#	PAGE#	ITEM#	PAGE#
70714	72	88088	91	99000	133				
70715	72	88112	59	99002	133				
70716	72	88116	59	99007	133				
70717	72	88120	60	99017	130				
70718	72	88122	60, 124	99019	131				
70719	72	88128	59	99030	133				
70720	72	88130	58	99032	134				
70721	72	88131	58	99033	134				
70722	72	88132	58	99034	134				
70723	72	88133	58	99035	134				
70724	72	88134	58	99036	134				
70725	72	88200	85	99041	130				
70726	72	88201	85	99042	131				
70727	72	88207	99	99043	131				
70728	73	88208	91	99045	131				
70729	73	88210	57	99049	132				
70730	73	88212	59	99050	132				
70731	73	88214	56	99051	132				
70732	73	88215	57	99053	134				
70733	73	88216	60	99056	131				
70734	73	88217	56	99057	131				
70735	73	88218	56	99059	132				
70736	73	88219	56	99060	133				
70737	73	88220	56	99065	131				
70738	73	88221	56	99066	134				
70739	73	88222	56	99068	130				
70740	73	88223	60	99070	131				
70741	73	88224	56	99071	131				
70742	73	88225	57	99072	132				
70743	73	88226	56	99073	130				
70744	76	88229	57	99074	131				
78001	129	88234	58	99079	131				
78008	128	88235	58	99083	122				
78008B	128	88236	58	99084	134				
78009	128	88237	57	99085	134				
78009B	128	88238	59	99086	134				
78010	128	88239	56	99099	134				
78011	128	88240	56	99101	133				
78012	128	88241	57	A6202	126				
78013	128	88242	56	C5036-3	91				
78013B	128	88243	57	C5038B	129				
78014	128	88244	56	C5038K	129				
78014B	128	88245	57	C5038R	129				
78015	128	88246	56	C5038W	129				
78016	128	88247	57	S1001	126				
78016B	128	88248	58	S1002	126				
78017	128	88249	58						
78018	128	88250	58						
78019	128	88257	57						
88004	91	88258	57						
88016	60	88261	59						
88063	102	91001	84						
88065	102	91011	84						
88082	44	91250	69						



Freightliner Interior Catalog  
UPauto.com/truck  
3788 E. Conant St., Long Beach, CA 90808 | t: 800.790.6988 | f: 888.986.5988  
© United Pacific Industries, Long Beach, CA 90808. All Rights Reserved.

 Like us on Facebook: [www.facebook.com/uptruckparts](http://www.facebook.com/uptruckparts)

**UCFL3**  
FREIGHTLINER INTERIOR PRODUCT  
CATALOG - 3RD EDITION



710270056354