



United Pacific

# TRUCK

*2018 Stainless Steel Products*





# United Pacific

## HOW TO ORDER

To order from United Pacific Industries, you must be an authorized dealer, distributor or OEM.  
If you are not authorized to stock and sell United Pacific products, you must order through an authorized dealer.  
Please call 800.790.6988 for more information.

## CONTACT US

 8 am - 4:30 pm PST

 800.790.6988 / 562.421.3888

 888.986.5988

 [Sales@upauto.com](mailto:Sales@upauto.com)

 [UPauto.com](http://UPauto.com)

 3788 E. Conant St., Long Beach, CA 90808

## QUALITY

With over 30 years of experience in the automotive aftermarket industry, United Pacific Industries understands the rigors and stresses that our products are subjected to on the road. It is our mission to provide our customers with products of superior quality and reliability. In achieving this goal, United Pacific only partners with manufacturing facilities that conforms to our quality control requirements and standards. Our manufacturing partners meet or exceed ISO-9001 requirements. In addition, United Pacific's manufacturing partners must be equipped on site to perform the following quality assurance tests and maintain a track record of consistent quality and low product failure rate.

- Aging Test
- Air Tight Test
- Dust Test
- Flux Test
- Photometric Test
- Pull Force Test
- Rain Test
- Salt Spray Test
- Shock Test
- Temperature Test
- Humidity Test
- Vibration Test

Furthermore, our internal quality control structure allows us to function as the final quality control station prior to shipping. With the assistance of 3D computer technology, United Pacific can adhere to strict quality control standards during prototype creation and the production process. Our engineers and technicians perform a battery of tests to ensure that our products meet the demands of today's drivers and our goal to be first in quality.

## INNOVATION

Known as the leader in innovation, United Pacific is dedicated to be the first to bring new and exciting products to the market. United Pacific's global expertise allows us to search the globe for new ideas and concepts. Not only do we search the globe for new products, United Pacific invest a significant amount of resources into our own research and development efforts. With the assistance of advance 3D scanning technology, our engineers and designers can acquire accurate and precise data in seconds.

The 3D data allows United Pacific to verify designs, perform quality assurance tests, and reverse engineer with unprecedented speed and accuracy. Digital inspection contributes to the early detection of shape problems, provides rapid feedback on design, and eliminates unnecessary work in downstream processes. Our rapid prototyping facility permits us to have a concept-to-shelf time of less than 5 months. In addition, United Pacific's 3D printing capabilities permit our designers to have physical models of their design concepts in hours. The physical models allow our designers and marketing staff to evaluate and test the viability of different design ideas. Our rapid prototyping facility allow United Pacific to compress design cycles, improve manufacturing planning, shorten concept-to-shelf time, most importantly, generate new and innovative products.

## DESIGN

Located near some of the nation's most progressive automotive design centers, United Pacific established the UP Design Studio in 2002 to consolidate our position as the design leader in the automotive industry. UP Design Studio utilizes the latest generation of computer aided design (CAD) and studio/graphic software. The design studio is equipped with the newest computers and rapid prototyping systems. In addition, UP Design Studio is staffed by graduates from the nation's most prestigious design colleges. Unlike our competitors, United Pacific's design and manufacturing capabilities mean that we carry more new and original items than our competitors. The establishment of the design studio will enable us to generate even more new products with significant shorter concept-to-shelf time. The reduction in development cost mean that we can develop products utilizing design based development processes. Design based product development allows United Pacific to create new product concepts based on designs incorporating driver demands and needs instead of economic considerations. United Pacific's emphasis on design distinguishes and positions us ahead of our competitors.



## WARRANTY

With LED (Light Emitting Diodes) rated at 100,000 hours of operation and solid-state construction, United Pacific's LED lights are extremely reliable and durable. Purchase with confidence, United Pacific offers a complete line of LED lighting products with extended or limited lifetime warranties. Please see the warranty policy page for more details.

## INVENTORY AND SHIPPING

United Pacific carries over 20,000 items in our California distribution center. No other company in the heavy duty trucking industry can match United Pacific in the variety and range of in-stock inventories. With an order fill rate of over 98.5%, United Pacific is the largest and most reliable supplier in the industry. Our shipping department ships 96.8% of all orders within 24 hours and 98.9% within 48 hours. United Pacific's vast inventory and prompt shipping has made United Pacific the only source for our customer's chrome and lighting needs.



HARD AT WORK FOR THE ENVIRONMENT



**United Pacific**  
**132,000** sq ft

**Distribution Center**  
**Long Beach, CA**

- 100%** reduction in potable water used for landscaping
- 40%** reduction in total energy use due to high-efficiency mechanical and lighting systems
- 82%** of construction waste was diverted from landfills

## LEED ACCOMPLISHMENTS

### Sustainable Sites

- On-site bicycle storage, showers and changing areas for company employees.
- Preferred parking for low-emitting, fuel-efficient and carpool vehicles.
- Stormwater is infiltrated on-site and treated to remove contaminants to reduce environmental impact on local waterways.

### Water Efficiency

- In addition to using reclaimed water, drought-tolerant plants and a high-efficiency irrigation system were installed to reduce the use of potable water for irrigation by 100%.

### Energy and Atmosphere

- Efficient HVAC equipment and a lighting system with daylight controls reduces energy consumption by over 30%.
- Enhanced commission verifies that the building's energy and water-related systems are performing as intended by the initial design.

### Indoor Environmental Quality

- Building ventilation systems was designed to provide enhanced levels of fresh outside air to building occupants.
- Interior finishes (plants, sealants, adhesives, coatings, carpet systems and composite wood) were selected with low levels of volatile organic compounds (VOCs) to reduce indoor air contamination.



# FREIGHTLINER

## Bug Deflectors



**Stainless Steel Bug Deflector for 2013+ Freightliner Coronado SD**

- Highly polished 430 stainless steel
- Mounting holes pre-punched for easy installation
- Drilling required for mounting
- Installation hardware included

**29100** 1 Pc. / Box



**Stainless Steel Bug Deflector for 2010+ Freightliner Coronado**

- Highly polished 430 stainless steel
- Mounting holes pre-punched for easy installation
- Drilling required for mounting
- Installation hardware included

**29097** 1 Pc. / Bulk



**Stainless Steel Bug Deflector for Freightliner Classic/Classic XL**

- Highly polished 430 stainless steel
- Mounting holes pre-punched for easy installation
- Drilling required for mounting
- Installation hardware included

**29094** 1 Pc. / Box



**Stainless Steel Bug Deflector for 2008+ Freightliner Columbia**

- Highly polished 430 stainless steel
- Mounting holes pre-punched for easy installation
- Drilling required for mounting
- Installation hardware included

**29092** 1 Pc. / Box

# FREIGHTLINER

## Bug Deflectors / Drop Visor



### Stainless Steel Bug Deflector for 2008+ Freightliner Cascadia

- Highly polished 430 stainless steel
- Mounting holes pre-punched for easy installation
- Drilling required for mounting
- Installation hardware included

**29090** 1 Pc. / Box



### Stainless Steel Bug Deflector for Freightliner FLD 120/112

- Highly polished 430 stainless steel
- Mounting holes pre-punched for easy installation
- Drilling required for mounting
- Installation hardware included

**29093** 1 Pc. / Box



### Stainless Steel Bug Deflector for 2005+ Freightliner Century

- Highly polished 430 stainless steel
- Mounting holes pre-punched for easy installation
- Drilling required for mounting
- Installation hardware included

**29091** 1 Pc. / Box



### Stainless Steel Condo Drop Visor for Freightliner Classic/FLD

- Stainless steel 12 1/2" Condo Drop Visor
- Fits Freightliner Classic/FLD (Stand-Up) condo with OEM Fiberglass visor
- Mounting hardware included

**28000** 1 Pc. / Box

## **FREIGHTLINER**

### **Drop Visor / Antenna Bracket / Vend Door Cover & Trim**

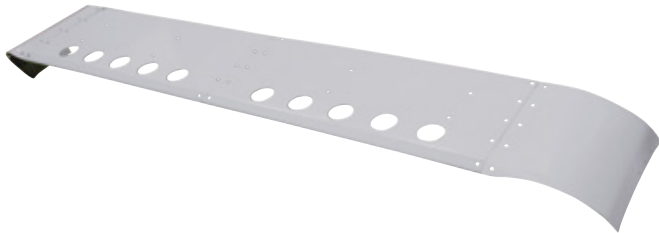

#### **Stainless Steel Condo Drop Visor for Freightliner Classic/FLD**

- Stainless steel 12 1/2" Condo Drop Visor
- Ten 2" light cutouts
- Fits Freightliner Classic/FLD (Stand-Up) Condo with OEM fiberglass visor
- Mounting hardware included

**28003** 1 Pc. / Box



#### **Stainless Steel Antenna Bracket for Freightliner Cascadia Light**

- Stainless steel single stud Pedestrian light and CB antenna bracket for Freightliner Cascadia
- Mounts onto various Freightliner Cascadias
- Sold individually, please specify LH or RH

**42374** **Driver Side** - 1 Pc. / Box

**42375** **Passenger Side** - 1 Pc. / Box



#### **Stainless Steel Vent Door Cover and Dimpled Trim Set for Freightliner**

- Each set includes 2 vent door covers and 2 dimpled trim pieces
- Available for Freightliner without louver
- Mounting hardware included

**20564** 4 Pcs. / Set



#### **Stainless Steel Dimpled Vent Door Trim for Freightliner**

- Highly polished stainless steel
- Double sided tape on back for easy installation

**20566** 2 Pcs. / Card



# FREIGHTLINER

## Window Trim / Vent Door / License Plate Holder



### Stainless Steel Lower Sleeper Window Trim for Freightliner

- Highly polished 430 stainless steel
- Mounting holes pre-punched for easy installation
- Drilling required for mounting
- Installation hardware included

**21724** 1 Pc. / Skin Pack



### Stainless Steel Louvered Vent Door Cover for Freightliner

- 8 3/4" x 4 1/2"

**20571** 1 Pair / Card



### Stainless Steel Curved View Window Trim for Freightliner

- Highly polished stainless steel
- Sealant adhesive included

**21719** 1 Pc. / Bulk

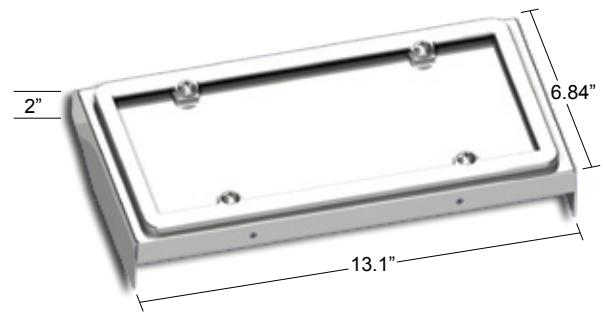

### Stainless Steel License Plate Holder for 2008-2017 Freightliner Cascadia

- Highly polished 430 stainless steel
- Mounting holes pre-punched for easy installation
- Drilling required for mounting
- Installation hardware included

**29098** 1 Pc. / Box



**Extended Hood Stainless Grille with Oval Holes for Peterbilt 379**

- Highly polished 430 stainless steel
- Fits 127" extended hood, long nose grille with oval cutout
- Alternating hole pattern
- Installation hardware included

**21061** 1 PC. / Box

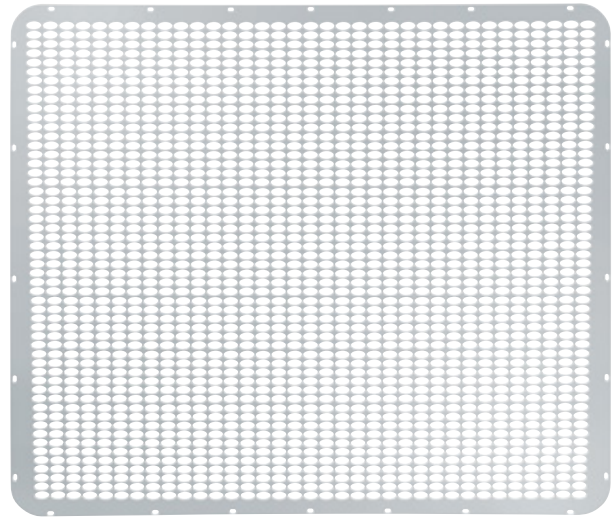

**Extended Hood Stainless Steel Grille with Straight Holes for Peterbilt 379**

- Highly polished 430 stainless steel
- Fits 127" extended hood, long nose grille with oval cutout
- Straight hole pattern
- Installation hardware included

**21062** 1 Pc. / Box

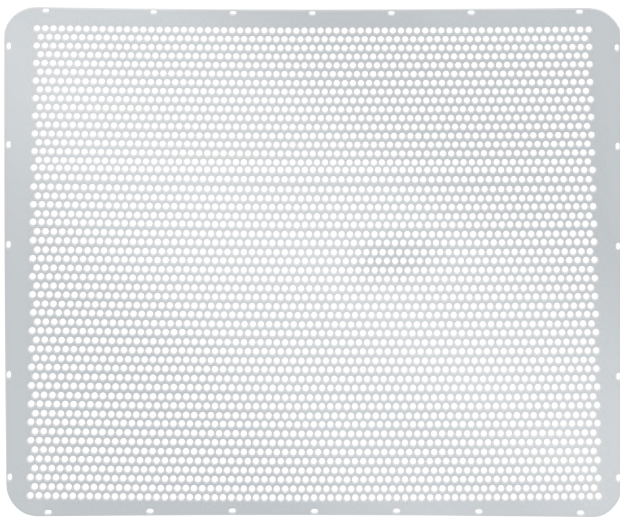

**Extended Hood Stainless Grille with Round Holes for Peterbilt 379**

- Highly polished 430 stainless steel
- Fits 127" extended hood, long nose grille with round cutout
- Alternating hole pattern
- Installation hardware included

**21063** 1 PC. / Box

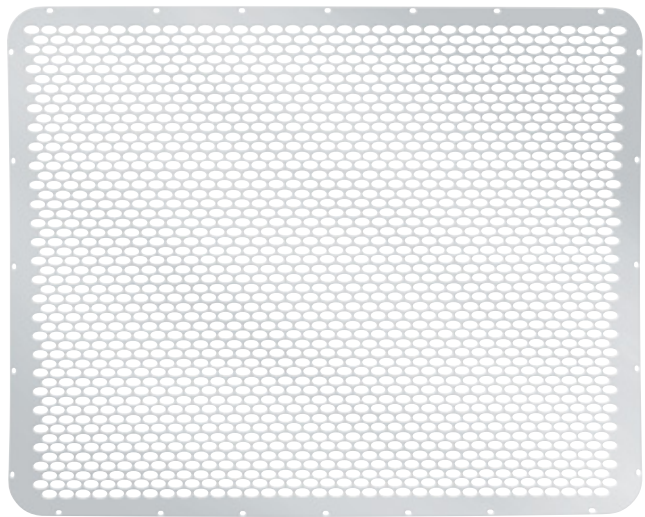

**Extended Hood Stainless Steel Grille with Oval Holes for Peterbilt 379**

- Highly polished 430 stainless steel
- Mounting holes pre-punched for easy installation
- Drilling required for mounting
- Installation hardware included

**21064** 1 Pc. / Box

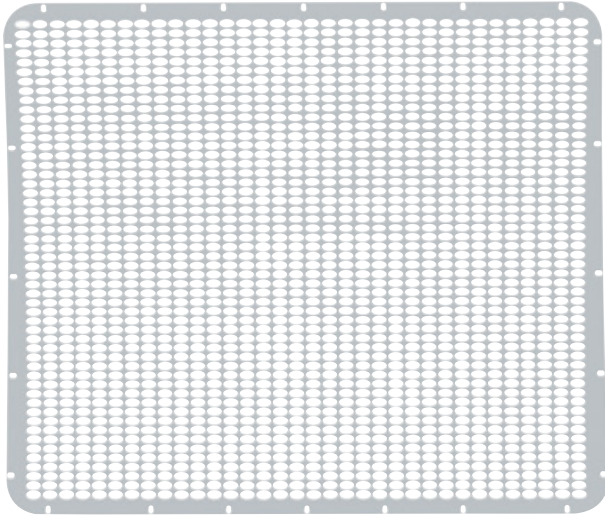

**Stainless Steel Grille for Extended Hood  
Peterbilt 379**

- Highly polished 304 stainless steel
- Fits 127" hood, long nose grille with oval cutout

**21151** 1 Pc. / Box

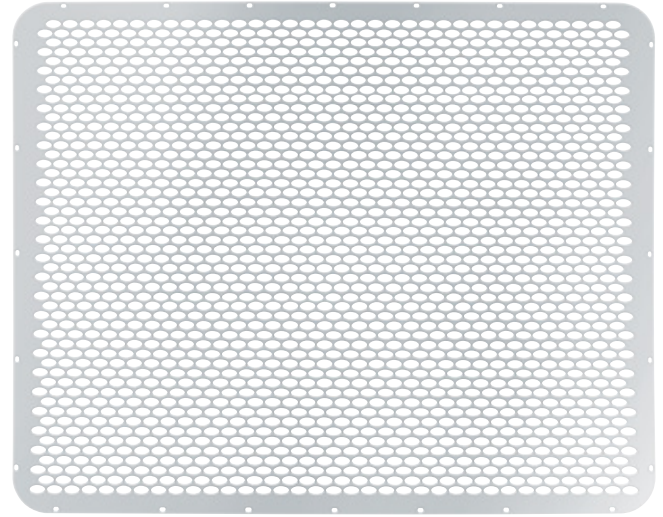

**Stainless Steel Grille with Alternating Oval Holes  
For Short Hood Peterbilt 379**

- Highly polished 304 stainless steel
- Fits short nose grille with oval cutout

**21152** 1 Pc. / Bulk

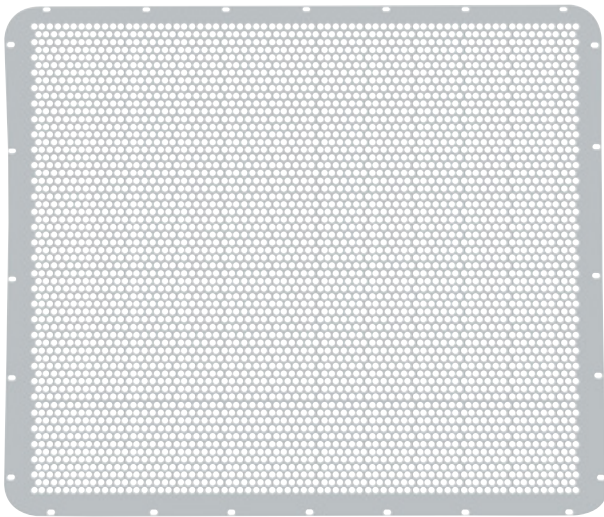

**Stainless Steel Grille with Alternating Round Holes  
for Extended Hood Peterbilt 379**

- Highly polished 304 stainless steel
- Fits 127" hood, long nose grille with 7/16" cutout

**21153** 1 Pair / Box

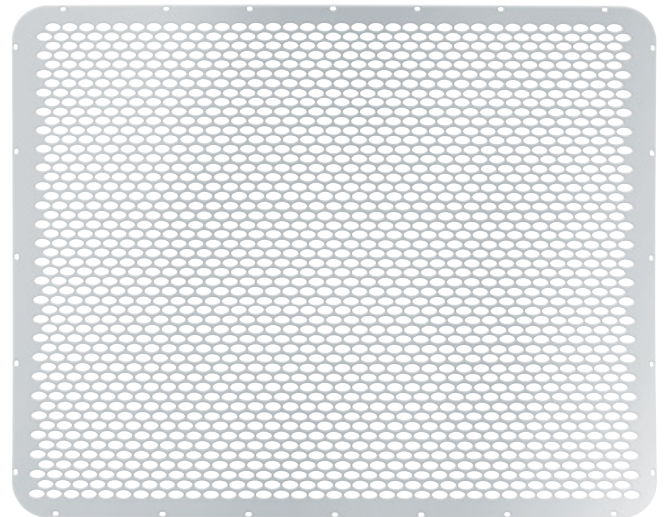

**Stainless Steel Grille with Straight Oval Holes for  
Extended Hood Peterbilt 379**

- Highly polished 304 stainless steel
- Fits 127" hood, long nose grille with oval cutout

**21154** 1 Pair / Box

## **PETERBILT**

### **Grille Bars & Side Grille Deflector**



#### **Stainless Steel 33 1/2" Grille Bar for Peterbilt/Kenworth**

- Highly polished stainless steel
- OEM style
- Bolt mount included

**21160** 1 Pc. / Box



#### **Stainless Steel 34" Grille Bar for Peterbilt 379**

- Highly polished 304 stainless steel
- For Peterbilt 379 and various other models
- OEM style 34" length x 1-3/4" width, mounting hardware included

**21166** 1 Pc. / Bulk



#### **Stainless Steel 34" Grille Bar Cover for Peterbilt**

- Highly polished 304 stainless steel
- OEM style & size, fits over original bar
- 34 x 1-3/4" hollow back, mounting hardware included

**21165** 1 Pc. / Box



#### **Stainless Steel Side Grille Deflector for Peterbilt 379 W/ 4 Headlight System**

- Highly polished stainless steel
- Mounting hardware included
- Without LED cutouts

**20695** 1 Pair / Card

**PETERBILT**  
Bug Deflectors

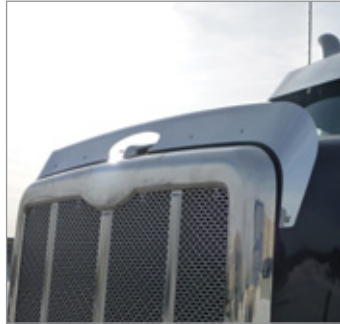

**Stainless Steel Bug Deflector for 2014+ Peterbilt 567**

- Highly polished 430 stainless steel
- Mounting holes pre-punched for easy installation
- Drilling required for mounting
- Installation hardware included

**29134** 1 PC. / Box



**Stainless Steel Bug Deflector for 2013+ Peterbilt 579**

- Highly polished 430 stainless steel
- Mounting holes pre-punched for easy installation
- Drilling required for mounting
- Installation hardware included

**29001** 1 Pc. / Box



**Stainless Steel Bug Deflector for Peterbilt 386**

- Highly polished 430 stainless steel
- Mounting holes pre-punched for easy installation
- Drilling required for mounting
- Installation hardware included

**29002** 1 Pc. / Box



**Stainless Steel Bug Deflector for 2007+ Peterbilt 388/389 Heavy Haul 367**

- Highly polished 430 stainless steel
- Mounting holes pre-punched for easy installation
- Drilling required for mounting
- Installation hardware included

**29003** 1 Pc. / Box

## **PETERBILT**

### **Bug Deflectors / Window Trim / Sunvisor**



**Stainless Steel Long Hood Model Bug Deflector for Peterbilt 379**

- Highly polished 430 stainless steel
- Mounting holes pre-punched for easy installation
- Drilling required for mounting
- Installation hardware included

**29000** 1 Pc. / Box

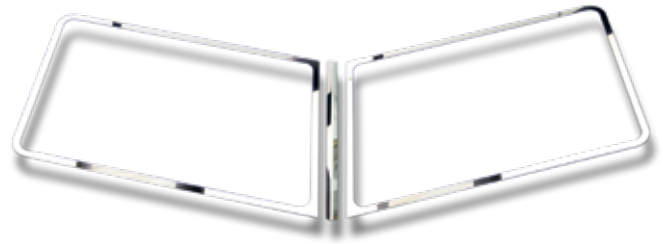

**Stainless Steel 3 Pc. Windshield Trim for 1987+ Peterbilt 379/386/388/389**

- Highly polished 430 stainless steel
- Completely covers the outer trim of the front windshield
- Easy installation with included double sided tape

**29130** 1 Pc. / Bulk

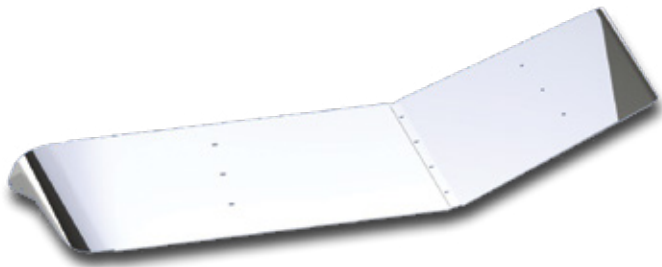

**Stainless Steel Plain Style Sunvisor for 2005+ Peterbilt 379/388/389/367 with Standard Cab 12" Extended - Non Louvered**

- Highly polished 430 stainless steel

**29128** 1 Pc. / Box

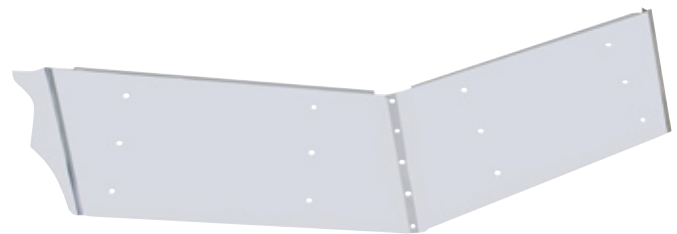

**Stainless Steel 13" Drop Sunvisor for Standard Cab Peterbilt 379/385/357**

- Highly polished 430 stainless steel

**28006** 1 Set / Box



**Stainless Steel 13" Low Roof Drop Sunvisor for 2004+ Peterbilt**

- Highly polished 430 stainless steel
- Fits various 2004 and newer Peterbilt models

**28008** 1 Set / Box



**Stainless Steel 13" Low Roof Drop Sunvisor w/ Ten 2" Light Cutouts for 2004+ Peterbilt**

- Highly polished stainless steel
- Fits various 2004 and newer Peterbilt models

**28009** 1 Set / Box



**Stainless Steel 14" Drop Sunvisor for 1997-2001 Ultra Cab Peterbilt 379 & 379X**

- Highly polished stainless steel
- Complete kit with stainless steel bracket

**28011** 1 Set / Box

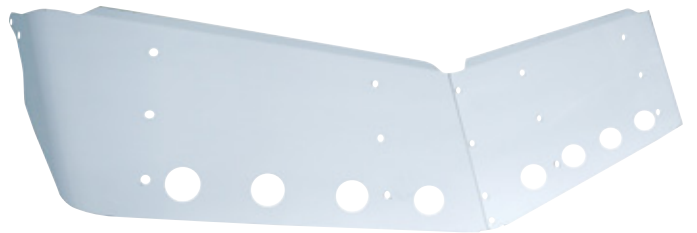

**Stainless Steel Drop Sunvisor w/ Eight 2" Light Cutouts for Ultra Cab Peterbilt 379 & 379X**

- Highly polished stainless steel
- Complete kit with stainless steel bracket

**28012** 1 Set / Box

# PETERBILT

## Sunvisor / Fender Guards



### Stainless Steel 14" Ultra Cab Drop Sunvisor for 2002+ Peterbilt 379

- Highly polished stainless steel
- Complete kit with stainless steel bracket

**28015** 1 Set / Box



### Stainless Steel Fender Guard for 2007+ Peterbilt 388/389

- Highly polished 430 stainless steel
- Mounts on the fender below the headlight
- Die stamped to match the curve of the fender section with pre-punched rivet holes
- Drilling required for mounting

**29129** 1 Pair / Box

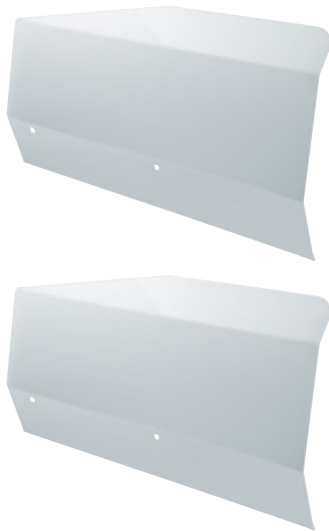

### Stainless Steel Front Fender Guards for Peterbilt 370

- Highly polished stainless steel

**20585** 1 Pair / Box



### Stainless Steel Fender Guards for 1986+ Peterbilt 378/349

- Highly polished 18 gauge 304 stainless steel
- Some drilling may be required for installation
- Mounting hardware included

**20572** 1 Pair / Box



**PETERBILT**

**Fender Guard / Vent Door Cover & Trim / Window Cover**

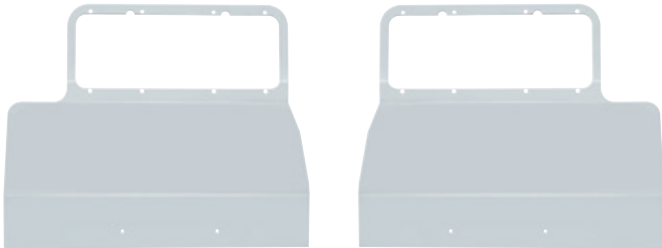

**Stainless Steel Fender Guard with Headlight Mount for 1986+ Peterbilt 378/379**

- Highly polished 304 stainless steel
- Some drilling may be required for installation
- Mounting hardware included

**20584** 1 Pair / Box



**Stainless Steel Vent Door Cover and Dimpled Trim Set for Peterbilt**

- Highly polished stainless steel
- Fits Peterbilt without Louver
- Set includes 2 vent door covers and 2 dimpled trims

**20562** 4 Pcs. / Card

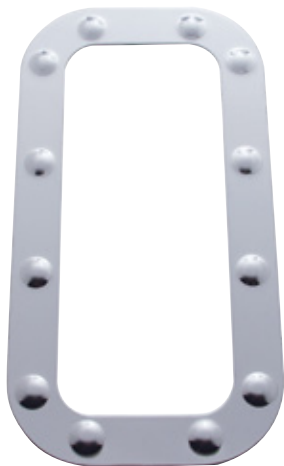

**Stainless Steel Dimpled Vent Door Trim for Peterbilt**

- Highly polished stainless steel
- Mounting hardware included
- Set includes 2 dimpled vent door trims

**20565** 2 Pcs. / Card



**Stainless Steel External View Window Cover for 2005+ Peterbilt**

- Highly polished stainless steel
- Includes adhesive backing

**21741** 1 Pc. / Skin Pack

## **PETERBILT**

Vent Door Cover / Window Trim / Tool Box Panel / Sleeper Shock Cover



### **Stainless Steel Vent Door Cover for Peterbilt 359/377 and 379**

- Highly polished stainless steel
- 9" x 3 3/4"

**20518** 2 Pcs. / Card



### **Stainless Steel Oval Window Trim for Peterbilt**

- Highly polished stainless steel
- Fits various Peterbilt models
- Includes sealant adhesive

**21718** 1 Pc. / Bulk



### **Stainless Steel Rear Sleeper Window Trim for Peterbilt**

- Highly polished stainless steel
- 36" x 19" center to center

**21723B** 1 Pc. / Card

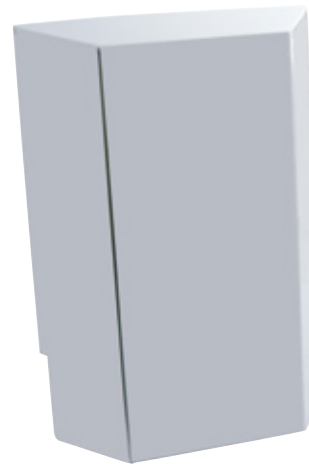

### **Stainless Steel Sleeper Shock Cover for Peterbilt**

- Highly polished stainless steel
- Includes double sided tape

**20610** 1 Pc. / Card

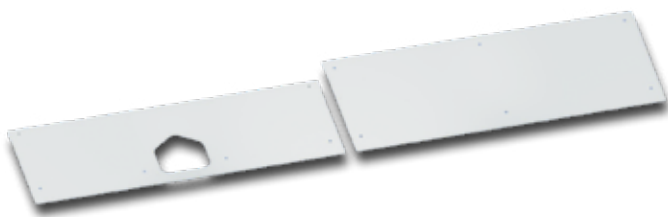

### **Stainless Steel Battery & Tool Box Panel for 1993 - 2007 Peterbilt 378/379**

- Highly polished 430 stainless steel
- Features pre-punched rivet mounting holes
- Laser cut pocket for tool box access T-handle

**29133** 1 Set / Box

## **PETERBILT**

### Window Trim, Window Shadow & Accent



**Stainless Steel 7" Chopped Window Trim for 2005+ Peterbilt 379/386/389/ and various other Peterbilt models with cab mounted mirrors**

- Highly polished 304 stainless steel
- Easy to install pressure sensitive adhesive mounting
- Includes 1 piece lefthand trim, 1 piece righthand trim

**29096** 1 Pair / Box

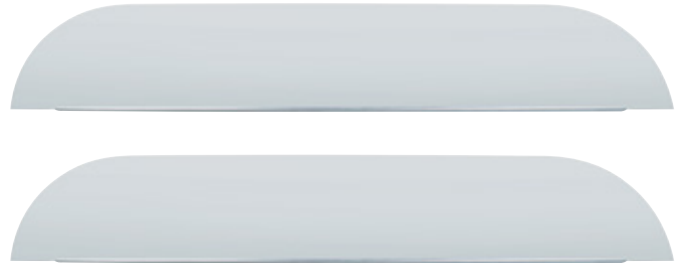

**Stainless Steel 5" Chopped Window Trim for 2005+ Peterbilt 379/386/389**

- Highly polished stainless steel
- Fits 2005+ Peterbilt 379/386/389 and various other Peterbilt models with cab mounted mirrors
- Sold in pairs

**29095** 1 Pair / Box



**Stainless Steel Door Window Shadow for Peterbilt 567/579 & Kenworth T680/T880**

- Highly polished 430 stainless steel
- Laser cut to match the curvature of the door window frame

**29135** 1 Pair / Box



**Stainless Steel Door Window Accent for Peterbilt 579**

- Highly polished 430 stainless steel
- Attaches using supplied 3M two-sided tape
- Sold in pairs

**29026** 1 Pc. / Box

# PETERBILT

## Window Accent / Back Step / Front Step / Step Trims



### Stainless Steel Door Window Accent for Peterbilt 387, 2011+ Peterbilt 587 & Kenworth T700

- Highly polished 430 stainless steel
- Attaches using supplied 3M two-sided tape
- Sold in pairs

**29046** 1 Pair / Card

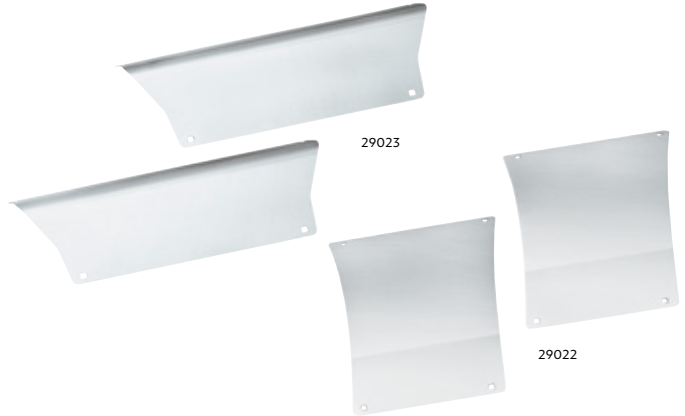

### Stainless Steel Back Step Trim for Peterbilt 579

- Highly polished 430 stainless steel
- Attaches using supplied 3M two-sided tape
- Sold in pairs, please specify upper or lower step trim

**29023** Upper Back Step Trim - 1 Pair / Card

**29022** Lower Back Step Trim - 1 Pair / Box



### Stainless Steel Front Step Trim for Peterbilt 579

- Highly polished 430 stainless steel
- Attaches using supplied 3M two-sided tape
- Sold in pairs

**29024** 1 Pair / Card



### Stainless Steel Front Step Trims for Peterbilt 386

- Highly polished 430 stainless steel
- Attaches using supplied 3M two-sided tape
- Sold in pairs

**29020** 1 Pair / Box

# PETERBILT

## Hood Emblem Accents / Flame Emblem Backing / Intake Grille



**Stainless Steel Hood Emblem Stripe Accent for 2007+ Peterbilt 389**

- Highly polished stainless steel
- Emblem accents are mounted using existing emblem mounting studs, and supplied 3M two-sided tape
- Sold in pairs

**29028** 1 Pair / Card



**Stainless Steel Hood Emblem Stripe Accent for 2007+ Peterbilt 388**

- Highly polished stainless steel
- Emblem accents are mounted using existing emblem mounting studs, and supplied 3M two-sided tape
- Sold in pairs

**29027** 1 Pair / Card

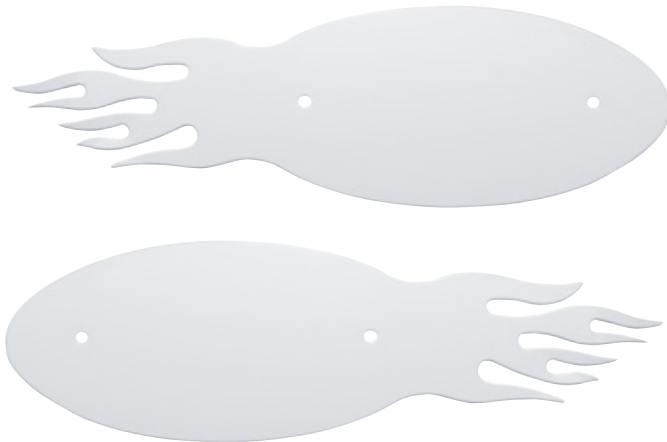

**Stainless Steel Flame Emblem Backing for Peterbilt**

- Highly polished stainless steel
- Stainless steel mounting hardware included
- Without LED cutouts

**10940** 1 Pair / Bulk

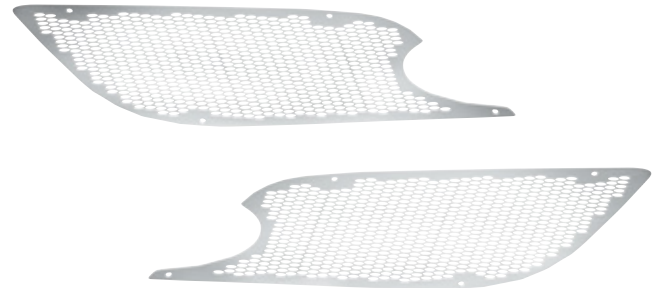

**Stainless Steel Intake Grille for 2013+ Peterbilt 579**

- Highly polished stainless steel
- Sold in pairs

**29021** 1 Pair / Card

# PETERBILT

## Door Handle Trim / License Plate Holders



**Stainless Steel Door Handle Trim for Peterbilt 567/579**

- Highly polished 430 stainless steel
- Attaches using supplied 3M two-sided tape
- Sold in pairs

**29025** 1 Pair / Card

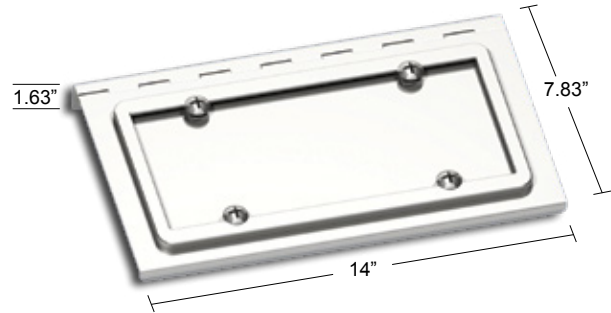

**Stainless Steel Single License Plate & Swing Plate for Peterbilt & Kenworth Models**

- Highly polished 430 stainless steel
- Install to existing license plate location
- License plate frame and hardware included

**29136** 1 Pc. / Bulk

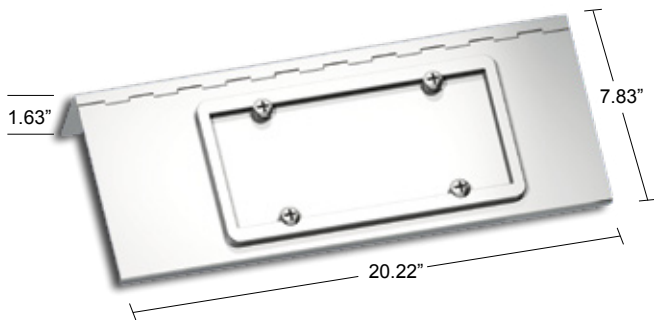

**Stainless Steel Single License Plate & Swing Plate for 2007+ Peterbilt 388/389**

- Highly polished 430 stainless steel
- Install to existing license plate location
- License plate frame and hardware included

**29132** 1 Pc. / Bulk

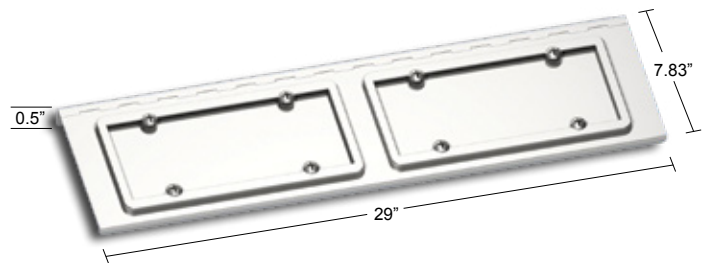

**Stainless Steel Dual License Plate & Swing Plate for All Peterbilt Models**

- Highly polished 430 stainless steel
- Install to existing license plate location
- License plate frame and hardware included

**29131** 1 Pc. / Bulk

**KENWORTH**  
Bug Deflector

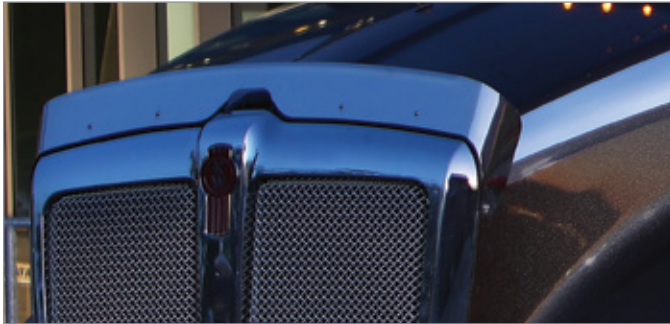

**Stainless Steel Bug Deflector for 2013+ Kenworth T680**

- Highly polished 430 stainless steel
- Mounting holes pre-punched for easy installation
- Drilling required for mounting,
- Installation hardware included

**29122** 1 Pc. / Box



**Stainless Steel Bug Deflector for 2011+ Kenworth T700**

- Highly polished 430 stainless steel
- Mounting holes pre-punched for easy installation
- Drilling required for mounting
- Installation hardware included

**29006** 1 Pc. / Box



**Stainless Steel Bug Deflector for Kenworth T660**

- Highly polished 430 stainless steel
- Mounting holes pre-punched for easy installation
- Drilling required for mounting
- Installation hardware included

**29005** 1 Pc. / Box



**Stainless Steel Bug Deflector for 2014+ Kenworth T880**

- Highly polished 430 stainless steel
- Mounting holes pre-punched for easy installation
- Drilling required for mounting
- Installation hardware included

**29109** 1 Pc. / Box



**Stainless Steel Bug Deflector for Kenworth W900B**

- Highly polished 430 stainless steel
- Mounting holes pre-punched for easy installation
- Drilling required for mounting
- Installation hardware included

**29010** 1 Pc. / Box



**Stainless Steel Bug Deflector for Kenworth W900L**

- Highly polished 430 stainless steel
- Mounting holes pre-punched for easy installation
- Drilling required for mounting
- Installation hardware included

**29011** 1 Pc. / Box



**Stainless Steel Bug Deflector for 1993-06 Kenworth T800 Wide Hood & C500**

- Highly polished 430 stainless steel
- Mounting holes pre-punched for easy installation
- Drilling required for mounting
- Installation hardware included

**29009** 1 Pc. / Box



**Stainless Steel Bug Deflector for Kenworth T600**

- Highly polished 430 stainless steel
- Mounting holes pre-punched for easy installation
- Drilling required for mounting
- Installation hardware included

**29004** 1 Pc. / Box



# KENWORTH

## Sun Visor / Fender Guard

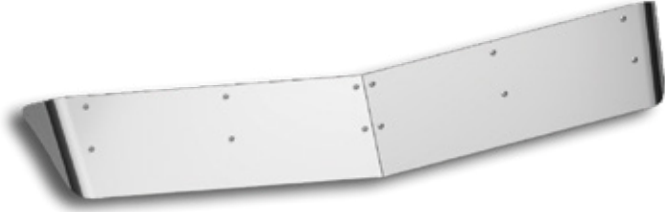

### Stainless Steel 10" Drop Style Sunvisor for 2007+ Kenworth Aerocab with Curved Glass & B-Cab

- Highly polished 430 stainless steel
- Drilling required for mounting
- Exposed-rivet style for that rugged look
- Replaces OEM "one piece visor"

**29102** 1 Pc. / Box



### Stainless Steel 13 1/2" Curved Windshield Drop Style Sunvisor for 1989 and newer Kenworth W900L, W900B & T800

- Highly polished 430 stainless steel
- Complete kit with stainless steel bracket

**28013** 1 Pc. / Box



### Stainless Steel Curved Windshield Drop Visor for Kenworth W900

- Highly polished stainless steel
- Mounting holes pre-punched for easy installation

**28002** 1 Pc. / Box



### Stainless Steel Fender Guards for 2007+ Kenworth T800 Curved Glass Models

- Highly polished 430 stainless steel
- Drilling required, hardware included
- Sold in pairs

**29043** 1 Pair / Card

**KENWORTH**  
Fender Guards

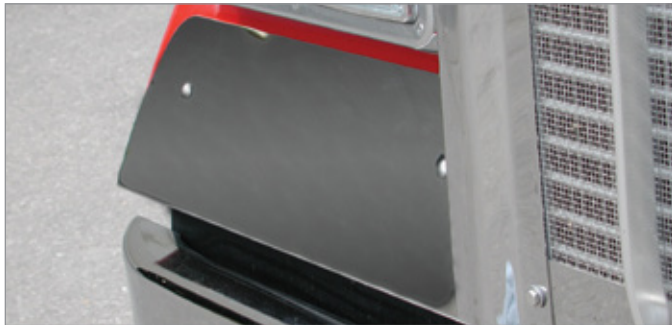

**Stainless Steel Under Headlight Fender Guard for 1989-2011 Kenworth W900L**

- Highly polished 430 stainless steel
- Mounts on the fender below the headlight
- Pre-punched rivet holes, drilling required for mounting

**29115** 1 Pair / Card



**Stainless Steel Fender Guard for 2014 Kenworth T880**

- Highly polished 430 stainless steel
- Mounts on the fender below the headlight
- Die stamped to match the curve of the fender section with pre-punched rivet holes, drilling required for mounting

**29105** 1 Pair / Box

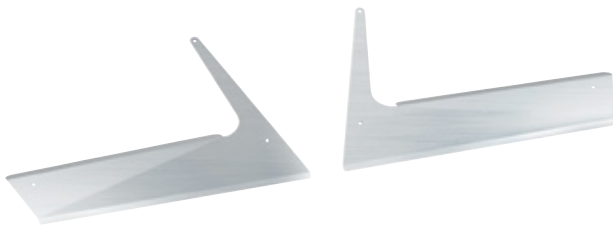

**Stainless Steel Fender Guards for Kenworth T800 Aerocab**

- Highly polished 430 stainless steel
- Drilling required, installation hardware included
- Sold in pairs

**29044** 1 Pair / Card



**Stainless Steel Above Headlight Fender Guards for Kenworth T600**

- Highly polished 430 stainless steel
- Drilling required, installation hardware included
- Sold in pairs

**29041** 1 Pair / Card

## **KENWORTH**

### Fender Guard / Window Shades & Accents



#### Stainless Steel Below Headlight Fender Guards for Kenworth T600

- Highly polished 430 stainless steel
- Drilling required, installation hardware included
- Sold in pairs

**29042** 1 Pair / Card



#### Stainless Steel Front Fender Guards for 2002 Kenworth W900

- Highly polished stainless steel

**20583** 1 Pair / Bulk



#### Stainless Steel Door Window Shade for All Kenworth Trucks with Daylight Doors & Passenger Side Single Convex Mirror

- Highly polished 430 stainless steel
- Laser cut to match the curvature of the door window frame
- Features clearance notch for RH side's over-the-door convex mirror bracket

**29112** 1 Pair / Box



#### Stainless Steel Door Window Accent for Peterbilt 387, 2011+ Peterbilt 587 & Kenworth T700

- Highly polished 430 stainless steel
- Attaches using supplied 3M two-sided tape
- Sold in pairs

**29046** 1 Pair / Card

## **KENWORTH**

### Door Trim / Lower Hood Panel / Tow Hole Cover / Vent Cover Kit



#### Stainless Steel Daylight Door Trim for 2008+ Kenworth Models with Daylight Door

- Highly polished 430 stainless steel
- Laser cut to match the curvature of the door window frame
- Precision punched round extrusions for door rivet clearance
- Attach to door via included double sided tape

**29108** 1 Set / Bulk

#### Stainless Steel Plain Lower Hood Panel for 1989+ Kenworth W900L

- Highly polished 430 stainless steel
- Pre-punched rivet and emblem mounting holes
- Emblem not included
- Drilling required for mounting

**29119** 2 Pc. / Box



#### Stainless Steel Bolt-less Tow Hole Cover for All Kenworth Models with 2" Receiver

- Highly polished 430 stainless steel
- Heavy duty spring loaded mounting design, keeps cover tightly secured to any 2" tow receiver without any addition hardware

**29103** 1 Set / Bulk

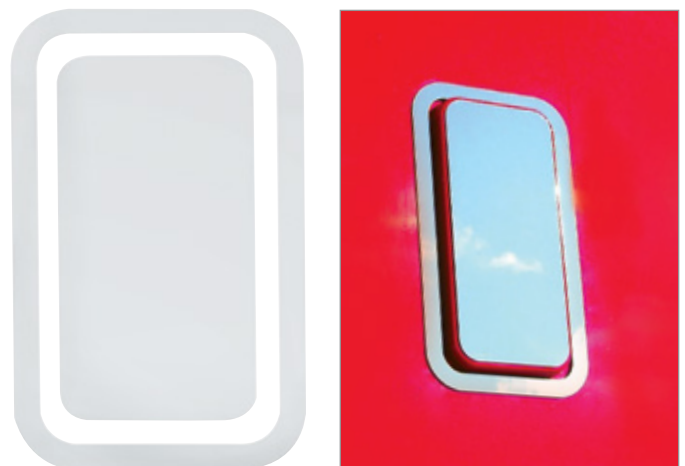

#### Stainless Steel Bunk Vent Cover Kit for Kenworth T700

- Highly polished 430 stainless steel
- The bunk vent cover kit consists of the vent cover and outer trim ring
- Attaches using supplied 3M two-sided tape
- Sold as a 2pc-piece kit

**29045** 1 Set / Card

# KENWORTH

## Vent Doors & Trims / Window Trim



Stainless Steel Plain Vent Door Cover for Freightliner

- Highly polished stainless steel
- 10 1/2" x 5"
- Sold in pairs

**20568** 2 Pcs. / Bulk



Stainless Steel Plain Vent Door Cover for Freightliner

- Highly polished stainless steel
- 8 3/4" x 4 1/2"
- Sold in pairs

**20570** 2 Pcs. / Bulk



Stainless Steel Vent Door Cover and Dimpled Trim Set for Kenworth

- Highly polished stainless steel
- Fits Kenworth without louver
- Set includes 2 vent door covers and 2 dimpled trims

**20563** 4 Pcs. / Card



Stainless Steel Dimpled Cab Vent Trim for Kenworth

- Highly polished stainless steel
- Attaches using supplied two-sided tape
- Sold in pairs

**20567** 2 Pcs. / Card

Stainless Steel Upper Sleeper Window Trim for Kenworth

- Highly polished stainless steel
- Please specify driver side or passenger side

**21721B** **Driver Side** - 1 Pc. / Bulk

**21722B** **Passenger Side** - 1 Pc. / Bulk

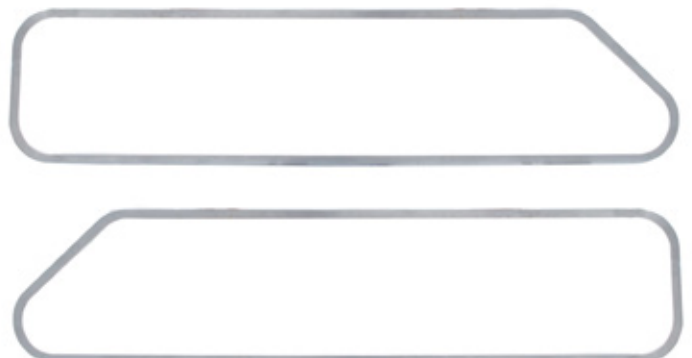

# KENWORTH

## Lower Sleeper Window Trim / Emblem Accents / Grille Bars

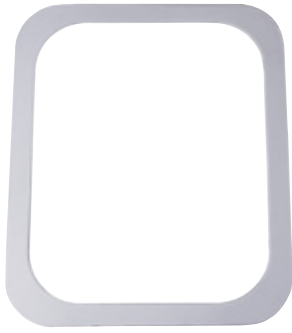

### Stainless Steel Lower Sleeper Window Trim for Kenworth

- Highly polished stainless steel

**21720** 1 Pc. / Skin Pack

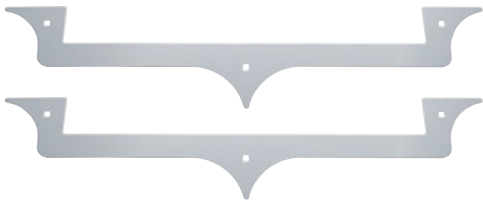

### Stainless Steel Emblem Accent for Kenworth

- Highly polished stainless steel
- Mounting hardware included

**10927** 1 Pair / Skin Pack

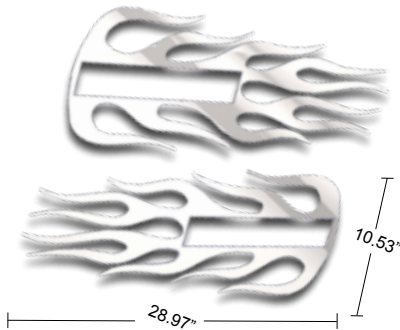

### Stainless Steel Hood Emblem Accent Flame for All Kenworth Models

- Highly polished 430 stainless steel
- Easy installation with included double sided tape

**29118** 1 Pair / Box



### Stainless Steel 39 1/2" Grille Bar for Kenworth

- Highly polished stainless steel
- Mounting hardware included

**21161** 1 Pc. / Box



### Stainless Steel 33 1/2" Grille Bar for Peterbilt & Kenworth

- Highly polished stainless steel
- OEM style design, bolt mount included

**21160** 1 Pc. / Box



### Stainless Steel 41" Center Grille Bar for Kenworth

- Highly polished stainless steel
- Mounting hardware included

**21162** 1 Pc. / Box

## **KENWORTH**

### **Air Intake Shroud & Cover / Fender Light Trim**



**Stainless Steel Air Intake Shroud for 1982 - 2007 Kenworth W900**

- Highly polished 430 stainless steel
- Mounts on the side of the hood, protects the air intake tubing from road debris
- Drilling required for mounting

**29106** 1 Pair / Box



**Stainless Steel Air Intake Cover for Kenworth T600/T800**

- Highly polished 430 stainless steel
- Installation hardware included

**29040** 1 Pc. / Card



**Stainless Steel Air Intake Shroud for 2008+ Kenworth T800 with Split Fender Metton Hood**

- Highly polished 430 stainless steel
- Mounts on the side of the hood, protects the air intake tubing from road debris
- Drilling required for mounting

**29110** 1 Pair / Box



**Stainless Steel Fender Light Trim for Kenworth T660**

- Highly polished 430 stainless steel
- Attaches using supplied 3M two-sided tape
- Sold in pairs

**29056** 1 Pair / Card

# KENWORTH

## Logo Trim / Air Intake Grille / Front Upper Step Kick Plate



### Stainless Steel Air Intake Logo Trim for 2008+ Kenworth T660/T370

- Highly polished 430 stainless steel
- Attaches using supplied hardware and 3M two-sided tape

**29051** 1 Pc. / Card



### Stainless Steel Hood Logo Trim for 2007+ Kenworth T660/T370

- Highly polished 430 stainless steel
- Attaches using supplied 3M two-sided tape
- Sold in pairs

**29052** 1 Pair / Card

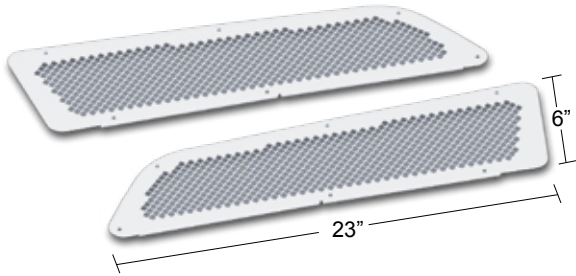

### Stainless Steel Air Intake Grille for 2014+ Kenworth T880

- Highly polished 430 stainless steel
- Mesh style design
- Installs to existing intake vent pocket

**29116** 1 Pair / Box



### Stainless Steel Front Upper Step Kick Plate for Kenworth T700

- Highly polished 430 stainless steel
- Hardware included
- Sold in pairs

**29048** 1 Pair / Box



# **KENWORTH**

## Front Lower, Upper & Back Upper Step Kick Plates

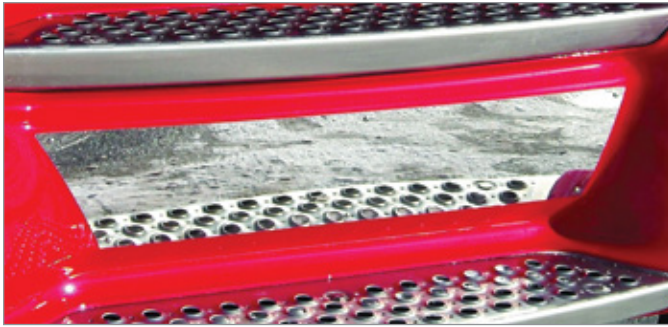

**Stainless Steel Front Lower Step Kick Plate for Kenworth T700**

- Highly polished 430 stainless steel
- Hardware included
- Sold in pairs

**29047** 1 Pair / Box



**Stainless Steel Front Upper Step Kick Plate for 2010+ Kenworth T660 (EPA)**

- Highly polished 430 stainless steel
- Attaches using supplied hardware to the upper step
- Sold in pairs

**29054** 1 Pair / Box



**Stainless Steel Front Upper Step Kick Plate for 2007-09 Kenworth T660**

- Highly polished 430 stainless steel
- Attaches using supplied hardware to the upper step
- Sold in pairs

**29053** 1 Pair / Box

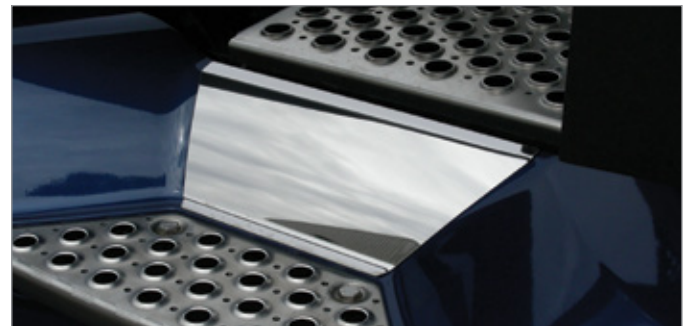

**Stainless Steel Back Upper Step Kick Plate for 2007+ Kenworth T660/T680/T700**

- Highly polished 430 stainless steel
- Attaches using supplied hardware and 3M two-sided tape
- Sold in pairs

**29050** 1 Pair / Box

**KENWORTH**

Back & Front Lower Step Kick Plates / Swing License Plates



**Stainless Steel Back Lower Step Kick Plate for 2007+ Kenworth T660/T680/T700**

- Highly polished 430 stainless steel
- Attaches using supplied hardware and 3M two-sided tape
- Sold in pairs

**29049** 1 Pair / Box

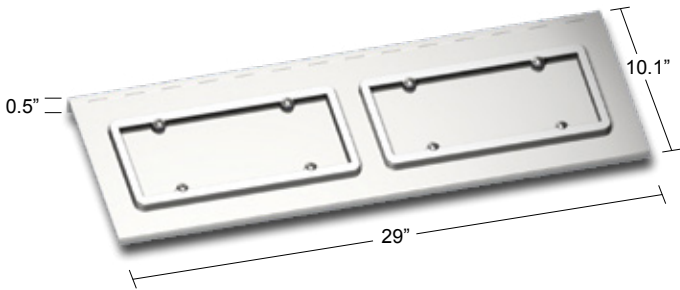

**Dual License Plate & Swing Plate Hinged Texas Style Design for 1993-2011 Kenworth W900**

- Highly polished 430 stainless steel
- Attaches using supplied hardware

**29120** 1 Pc. / Box

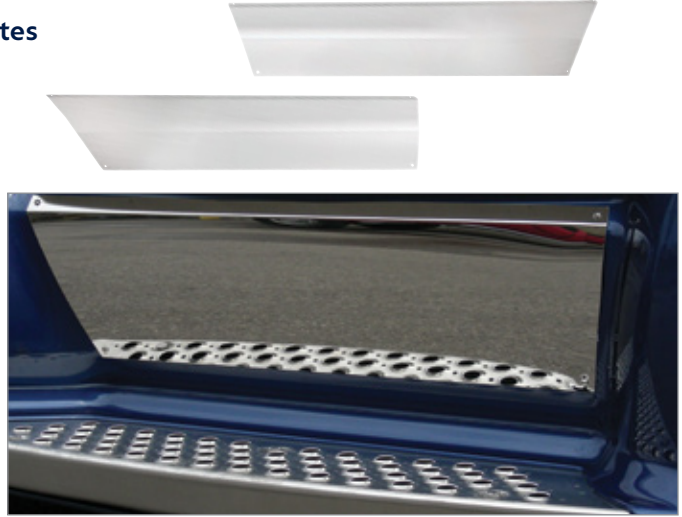

**Stainless Steel Front Lower Step Kick Plate for 2007+ Kenworth T660**

- Highly polished 430 stainless steel
- Attaches using supplied hardware, sold in pairs

**29055** 1 Pair / Box

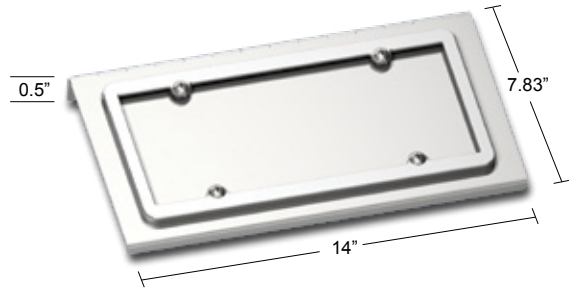

**Stainless Steel Single License Plate & Swing Plate for All Kenworth Models**

- Highly polished 430 stainless steel
- Install to existing license plate location
- License plate frame and hardware included

**29113** 1 Pc. / Bulk

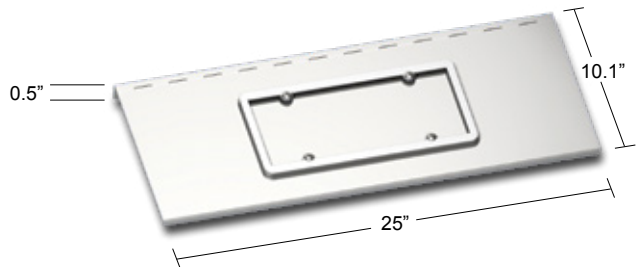

**Single License Plate & Swing Plate Hinged Texas Style Design for 1993-2011 Kenworth W900**

- Highly polished 430 stainless steel
- Attaches using supplied hardware

**29121** 1 Pc. / Box

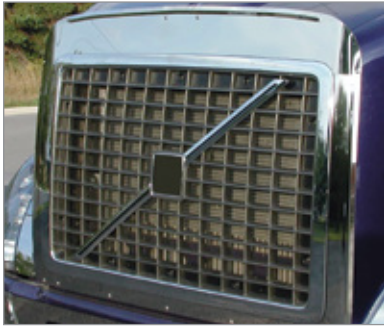

**Stainless Steel Bug Grille Deflector Kit for 2003+ Volvo VN**

- Highly polished 430 stainless steel
- Drilling of mounting holes through hood required
- Four piece stainless steel bug deflector and grille kit surround the grille

**29013** 1 Pc. / Box



**Stainless Steel Bug Deflector Kit for Volvo Day Cab 420/610/660/770**

- Highly polished 430 stainless steel
- Drilling of mounting holes through hood required, installation hardware included
- Mounts behind grille bezel

**29014** 1 Pc. / Box



**Stainless Steel Back Bug Deflector for 2003+ Volvo VN**

- Highly polished 430 stainless steel
- Drilling of mounting holes through hood required
- Installation hardware included

**29012** 1 Pc. / Box



**Stainless Steel Sunvisor Extension Strip for Volvo 660/670/770/780/880**

- Highly polished 430 stainless steel
- Provides additional 3" of visor coverage
- Easy installation, double sided tape and mounting screws included

**29141** 1 Pc. / Box

**Lower Step Kick Plates / Upper Fairing Kick Plate**

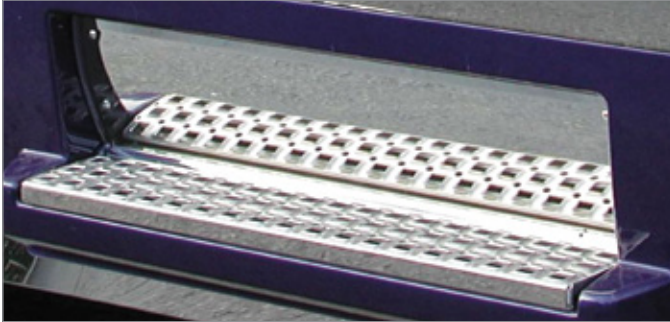

**Stainless Steel Step Front Lower Step Kick Plate for 2003+ Volvo VN**

- Highly polished heavy gauge 430 stainless steel
- Attaches using supplied hardware and 3M Two-sided tape
- Sold in pairs

**29062** 1 Pair / Card

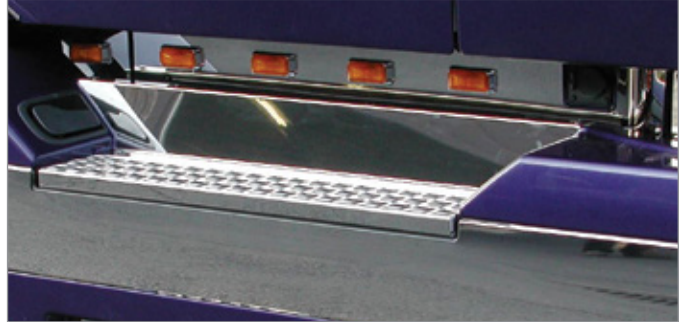

**Stainless Steel Front Upper Fairing Kick Plate for 2003+ Volvo VN**

- Highly polished 430 stainless steel
- Attaches using supplied hardware and 3M Two-sided tape
- Sold in pairs

**29064** 1 Pair / Box



**Stainless Steel Back Lower Step Kick Plate for 2003+ Volvo VN**

- Highly polished heavy gauge 430 stainless steel
- Attaches using supplied hardware and 3M Two-sided tape
- Sold in pairs

**29063** 1 Pair / Box



**Stainless Steel Back Lower Step Kick Plate for 2006+ Volvo VNL**

- Highly polished 430 stainless steel
- Attaches using supplied hardware and 3M Two-sided tape
- Sold in pairs

**29061** 1 Pair / Card



**Stainless Steel Front Lower Step Kick Plate for 2006+ Volvo VN**

- Highly polished 430 stainless steel
- Attaches using supplied hardware and 3M Two-sided tape
- Sold in pairs

**29060** 1 Pair / Card



**Stainless Steel Urea Tank Filler Cover Panel for 2011+ Volvo EPA**

- Highly polished 430 stainless steel
- Drilling of mounting holes through hood required
- Installation hardware included, sold in pairs

**29067** 1 Pair / Box

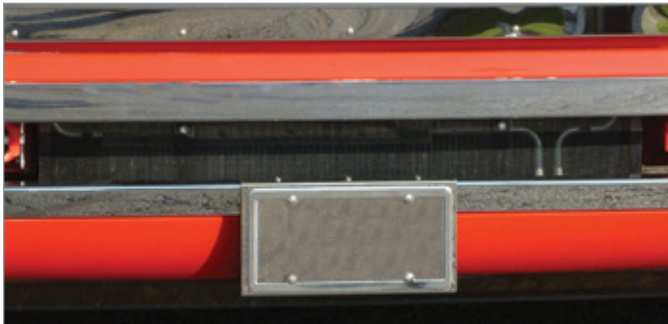

**Stainless Steel License Plate Holder for 2003+ Volvo VN**

- Highly polished 430 stainless steel
- License plate bezels included
- Attaches using supplied hardware

**29065** 1 Pc. / Box

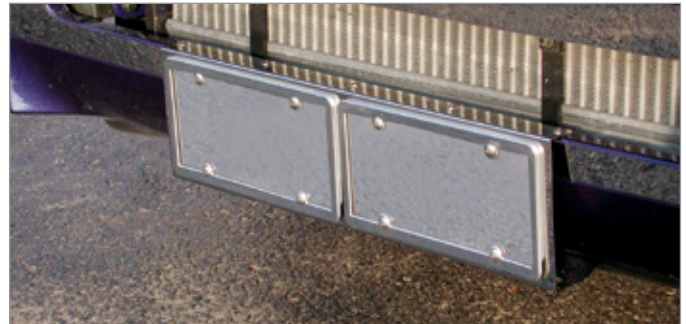

**Stainless Steel License Plate Holder for 2003+ Volvo VN**

- Highly polished 430 stainless steel
- License plate bezels included
- Attaches using supplied hardware

**29066** 1 Pc. / Box



**Stainless Steel Hood Trim for 2003+ Volvo VN/VL**

- Highly polished 430 stainless steel
- Attaches using supplied hardware and 3M two-sided tape
- Sold individually, please specify LH or RH side

---

**41667B**    **LH** - 1 Pc. / Box

---

**41668B**    **RH** - 1 Pc. / Box



**Stainless Steel Fender Guard for 2003+ Volvo VN/VNL**

- Highly polished 304 stainless steel
- Double sided tape mount included
- Sold in pairs

---

**29068**    1 Pair / Box



**Stainless Steel Door Handle Trim for Volvo VN/VT/VHD**

- Highly polished 430 stainless steel
- Protects key cylinder housing from key scratches
- Easy installation with included double sided tape



---

**29139**    1 Pair / Bulk

# MACK

## Bug Deflector / Sunvisor / Scuff Panel / Air Intake Trim

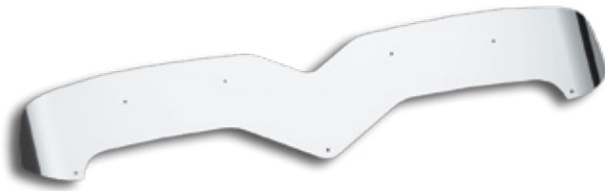

**Stainless Steel Bug Deflector for 2007+ Mack CXP613/GU813**

- Highly polished 430 stainless steel
- Precision cut to match the curvature of the hood and grille
- Mounting holes pre-punched for easy installation
- Drilling required, installation hardware included

**29123** 1 Pc. / Box

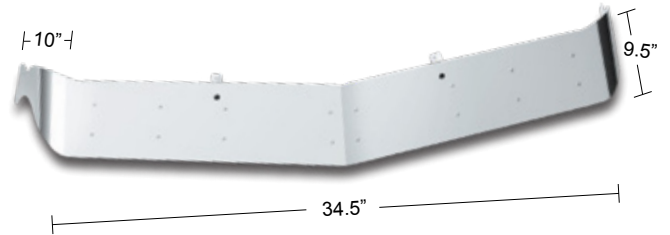

**Stainless Steel OEM Style Sunvisor for Mack CH/CX/Granite/Vision without Roof Fairing**

- Highly polished 430 stainless steel
- Precision punched mounting holes for easy replacement over original visor

**29125** 1 Pc. / Box



**Stainless Steel Upper Scuff Panel with Logo for Mack CH/CL**

- Highly polished 430 stainless steel
- Laser cut "Mack" logo
- Pre-punched rivet mounting holes
- Easy installation with included double sided tape

**29124** 1 Pair / Box

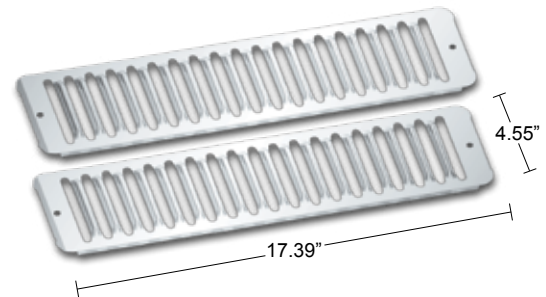

**Stainless Steel Hood Air Intake Trim for 1988+ Mack CH**

- Highly polished 430 stainless steel
- Mesh style design
- Installs to existing intake vent pocket

**29126** 1 Pair / Box

## **INTERNATIONAL**

### **Bug Deflectors / Fender Guards**



**Stainless Steel Bug Deflector for International 9900 Series/59001 SFA**

- Highly polished 430 stainless steel
- Drilling of mounting holes through hood required
- Installation hardware included
- Mounts behind grille bezel

**29016** 1 Pc. / Box



**Stainless Steel Bug Deflector for International ProStar**

- Highly polished 430 stainless steel
- Drilling of mounting holes through hood required
- Installation hardware included
- Mounts behind grille bezel

**29015** 1 Pc. / Box



**Stainless Steel Bug Deflector for 2002+ International 4000 Series**

- Highly polished 430 stainless steel
- Drilling of mounting holes through hood required
- Installation hardware included
- Mounts behind grille bezel

**29017** 1 Pc. / Box



**Stainless Steel Fender Guards for International ProStar**

- Highly polished 430 stainless steel
- Attaches using supplied 3M two-sided tap
- Sold in pairs

**29070** 1 Pair / Box



## **INTERNATIONAL**

### **Vent Covers / Grille Bar / Fuel Filler Insert Trim / Backup Light Bracket**

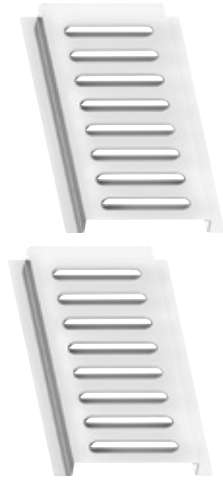

#### **Stainless Steel Louvered Vent Covers for International ProStar/LoneStar**

- Highly polished 430 stainless steel
- Attaches using supplied 3M two-sided tap
- Sold in pairs

**29071** 1 Pair / Card



#### **Stainless Steel 26 1/2" Grille Bar for International**

- Highly polished stainless steel
- Mounting hardware included

**21157** 1 Pc. / Box



#### **Stainless Steel Fuel Filler Insert Trim for International ProStar**

- Highly polished 430 stainless steel
- Attaches using supplied 3M two-sided tap
- Sold in pairs

**29073** 1 Pair / Card

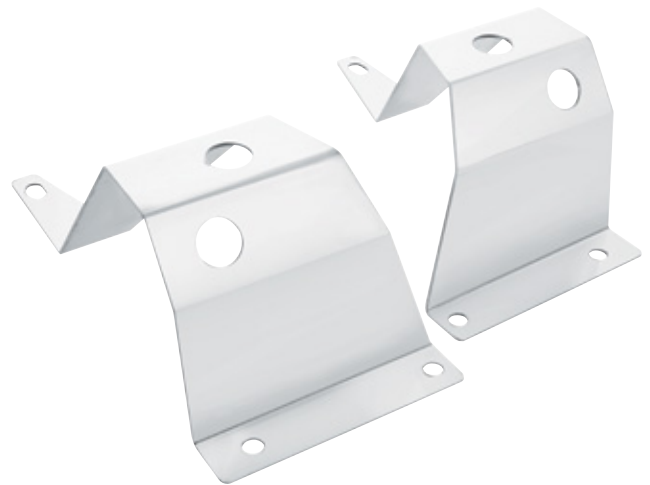

#### **Stainless Steel Backup Light Bracket for International**

- Stainless steel backup light bracket for International trucks
- Hardware not included
- 430 Stainless Steel, sold in pairs

**29072** 1 Pair / Box

## WESTERN STAR

### Bug Deflectors / Sunvisor / Fender Guards



#### Stainless Steel Bug Deflector for 2000 - 2018 Western Star 4964 SX with High Visibility Hood

- Highly polished 430 stainless steel
- Precision cut to match the curvature of the hood and grille
- Mounting holes pre-punched for easy installation
- Drilling required for mounting
- Installation hardware included

**29143** 1 Pc. / Box



#### Stainless Steel Bug Deflector for 2000+ Western Star 4964/FX/FA/EX/SX

- Highly polished 430 stainless steel
- Precision cut to match the curvature of the hood and grille
- Mounting holes pre-punched for easy installation
- Drilling required for mounting
- Installation hardware included

**29142** 1 Pc. / Box

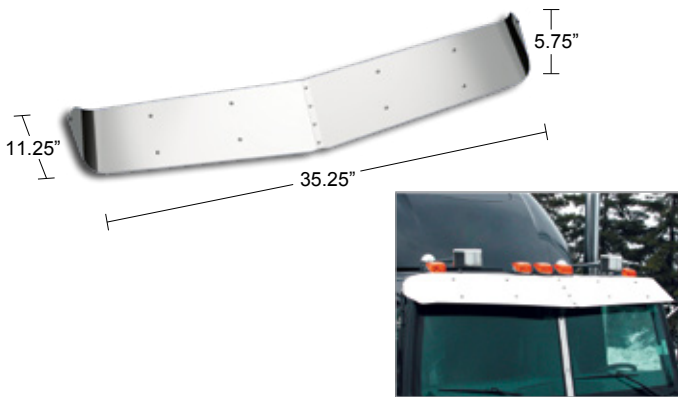

#### Stainless Steel Plain Style Sunvisor for 2002 - 2018 Western Star Constellation/4700 with OE Visor

- Highly polished 430 stainless steel
- Mounting holes pre-punched for easy installation
- Exposed-rivet style for that rugged look

**29144** 1 Pc. / Box



#### Stainless Steel Fender Guard with Curved End & Headlight Accent for 1998 - 2018 Western Star Constellation

- Highly polished 430 stainless steel
- Mounts on the fender below the headlight
- Die stamped to match the curve of the fender section
- 1 pc. design with headlight housing surround bezel
- Drilling required for mounting

**29145** 1 Pair / Box



#### Stainless Steel Fender Guard for 2007+ Western Star 4900/FA/EPA

- Highly polished 430 stainless steel
- Mounts on the fender below the headlight
- Die stamped to match the curve of the fender section
- 1 pc. with headlight housing surround bezel
- Drilling required for mounting



**29146** 1 Pair / Box

# UNIVERSAL

## License Plate Holders



### Stainless Steel 2 License Plate Holder

- Highly polished stainless steel

**21539** 1 Pc. / Bulk



### Stainless Steel 3 License Plate Holder

- Highly polished stainless steel

**21540** 1 Pc. / Box

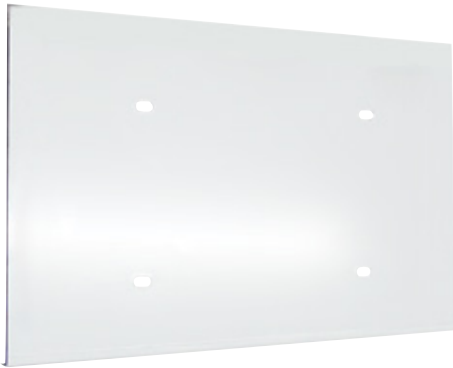

### Stainless Steel 14" x 8 1/4" 1 License Plate Holder

- Highly polished stainless steel

**21551** 1 Pc. / Bulk



### Stainless Steel 14 1/2" x 8 1/2" 1 License Plate Holder w/ Hinge

- Highly polished stainless steel

**21552** 1 Pc. / Bulk



### Stainless Steel 6" x 30" Permit Sticker Holder

- Highly polished 430 stainless steel
- Fits most makes and models
- Hardware included

**21533** 1 Pc. / Bulk



### Stainless Steel 6" x 36" Permit Sticker Holder

- Highly polished 430 stainless steel
- Fits most makes and models
- Hardware included

**21534** 1 Pc. / Bulk

**UNIVERSAL**

License Plate Holders / Cross Cutout / Small Gauge Cover



**Stainless Steel 7 1/2" x 18 1/4" 1 License Plate Holder**

- Highly polished stainless steel
- 7 1/2" width x 18 1/4" height
- Does not include lights, or frame

**21538** 1 Pc. / Bulk



**Small Gauge Cover with Visor and Blue Diamond**

- Signature chrome plastic gauge cover with crystal diamond
- Universal, fits various years and models
- US Patent: D563, 815S, D579, 809S, additional pat. pending

**20816** 1 Pc. / Card



**Stainless Steel 4" x 24" Standard Bottom Mud Flap Plate**

- Bolt through mounting
- Mounting hardware included

**21409** 1 Pc. / Bulk

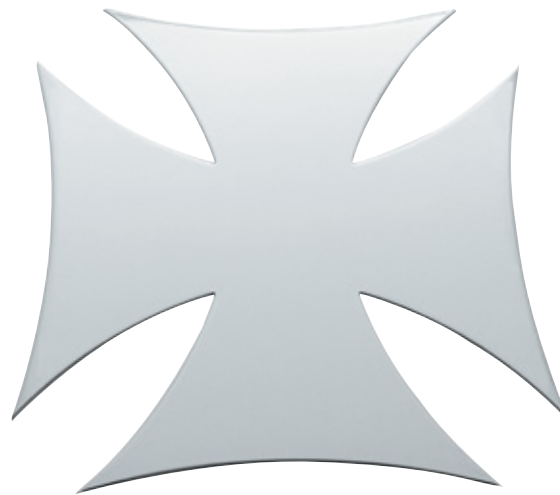

**Stainless Steel Maltese Cross Cutout**

- Highly polished stainless steel

|              |                             |              |
|--------------|-----------------------------|--------------|
| <b>10951</b> | <b>12"x12" Bolt Thru</b>    | 1 Pc. / Bulk |
| <b>10952</b> | <b>7"x7" Welded Studs</b>   | 1 Pc. / Bulk |
| <b>10953</b> | <b>7"x7" Bolt Thru</b>      | 1 Pc. / Bulk |
| <b>10954</b> | <b>12"x12" Welded Studs</b> | 1 Pc. / Bulk |
| <b>10955</b> | <b>7"x7" Welded Studs</b>   | 1 Pc. / Bulk |



**Stainless Steel 4" x 24" Standard Bottom Mud Flap Plate with Welded Stud**

- Welded stud mounting
- Mounting hardware included

**21411** 1 Pc. / Bulk

## UNIVERSAL

### 79 1/2" & 94" Bumper Light Brackets with LED lighting



#### 79 1/2" Stainless Steel Bumper Light Bracket with Six 14 LED 12" Light Bars - Amber LED/Amber Lens

- Highly polished stainless steel
- 79 1/2" x 1 3/8"
- 14 Amber LEDs with amber lens item # (38946B x 6)
- Stainless steel light bracket item # (20678)

**20671** 1 Pc. / Bulk

---



#### 79 1/2" Stainless Steel Bumper Light Bracket with Six 14 LED 12" Light Bars - Amber LED/Clear Lens

- Highly polished stainless steel
- 79 1/2" x 1 3/8"
- 14 Amber LEDs with clear lens item # (38948B x 6)
- Stainless steel light bracket item # (20678)

**20673** 1 Pc. / Bulk

---



#### 79 1/2" Stainless Steel Bumper Light Bracket with Six 14 LED 12" Light Bars - White LED/Clear Lens

- Highly polished stainless steel
- 79 1/2" x 1 3/8"
- 14 White LEDs with clear lens item # (39485B x 6)
- Stainless steel light bracket item # (20678)

**20675** 1 Pc. / Bulk

---



#### 79 1/2" Stainless Steel Bumper Light Bracket with Six 14 LED 12" Light Bars - Red LED/Chrome Lens

- Highly polished stainless steel
- 79 1/2" x 1 3/8"
- 14 Red LEDs with chrome lens item # (39645B x 6)
- Stainless steel light bracket item # (20678)

**20677** 1 Pc. / Bulk

---

## UNIVERSAL

### 79 1/2" & 94" Bumper Light Brackets with LED lighting



#### 79 1/2" Stainless Steel Bumper Light Bracket with Six 14 LED 12" Light Bars - Red LED/Red Lens

- Highly polished stainless steel
- 79 1/2" x 1 3/8"
- 14 Red LEDs with red lens item # (38947B x 6)
- Stainless steel light bracket item # (20678)

**20672** 1 Pc. / Bulk

---



#### 79 1/2" Stainless Steel Bumper Light Bracket with Six 14 LED 12" Light Bars - Amber LED/Clear Lens

- Highly polished stainless steel
- 79 1/2" x 1 3/8"
- 14 Red LEDs with clear lens item # (38949B x 6)
- Stainless steel light bracket item # (20678)

**20674** 1 Pc. / Bulk

---



#### 79 1/2" Stainless Steel Bumper Light Bracket with with Six 14 LED 12" Light Bars - Amber LED/Chrome Lens

- Highly polished stainless steel
- 79 1/2" x 1 3/8"
- 14 Amber LEDs with chrome lens item # (39644B x 6)
- Stainless steel light bracket item # (20678)

**20676** 1 Pc. / Bulk

---



#### 94" Stainless Steel Bumper Light Bracket with Seven 14 LED 12" Light Bars - Amber LED/Amber Lens

- Highly polished stainless steel
- 94" x 1 7/8"
- 14 Amber LEDs with amber lens item # (38946B x 6)
- Stainless steel light bracket item # (20870)

**20873** 1 Pc. / Bulk

---

## UNIVERSAL

### 94" Bumper Light Brackets with LED lighting



#### 94" Stainless Steel Bumper Light Bracket with Seven 14 LED 12" Light Bars - Amber LED/Clear Lens

- Highly polished stainless steel
- 94" x 1 7/8"
- 14 Amber LEDs with clear lens item # (38948B x 6)
- Stainless steel light bracket item # (20870)

---

**20875** 1 Pc. / Bulk

---



#### 94" Stainless Steel Bumper Light Bracket with Seven 14 LED 12" Light Bars - Red LED/Red Lens

- Highly polished stainless steel
- 94" x 1 7/8"
- 14 Red LEDs with red lens item # (38947B x 6)
- Stainless steel light bracket item # (20870)

---

**20874** 1 Pc. / Bulk

---



#### 94" Stainless Steel Bumper Light Bracket with Seven 14 LED 12" Light Bars - Red LED/Clear Lens

- Highly polished stainless steel
- 94" x 1 7/8"
- 14 Red LEDs with clear lens item # (38949B x 6)
- Stainless steel light bracket item # (20870)

---

**20877** 1 Pc. / Bulk

---



#### 94" Stainless Steel Bumper Light Bracket with Seven 14 LED 12" Light Bars - Amber LED/Chrome Lens

- Highly polished stainless steel
- 94" x 1 7/8"
- 14 Amber LEDs with chrome lens item # (39644B x 6)
- Stainless steel light bracket item # (20870)

---

**20879** 1 Pc. / Bulk

---

## UNIVERSAL

### 94" Bumper Light Brackets with LED lighting



#### 94" Stainless Steel Bumper Light Bracket with Seven 14 LED 12" Light Bars - Blue LED/Clear Lens

- Highly polished stainless steel
- 79 1/2" x 1 3/8"
- 14 Blue LEDs with clear lens item # (39483B x 6)
- Stainless steel light bracket item # (20870)

---

**20876** 1 Pc. / Bulk

---



#### 94" Stainless Steel Light Bracket with Seven 14 LED 12" Light Bars - White LED/Clear Lens

- Highly polished stainless steel
- 94" x 1 7/8"
- 14 White LEDs with clear lens item # (39485B x 6)
- Stainless steel light bracket item # (20870)

---

**20878** 1 Pc. / Bulk

---



#### 94" Stainless Steel Light Bracket with Seven 14 LED 12" Light Bars - Red LED/Chrome Lens

- Highly polished stainless steel
- 94" x 1 7/8"
- 14 Red LEDs with chrome lens item # (39645B x 6)
- Stainless steel light bracket item # (20870)

---

**20880** 1 Pc. / Bulk

---



## UNIVERSAL

### 94" Bumper Light Brackets with LED lighting



#### 94" Stainless Steel Bumper Light Bracket with Seven 19 LED 12" Reflector Light Bars - Amber LED/Amber Lens

- Highly polished stainless steel
- 94" x 1 7/8"
- 19 Amber LEDs with amber lens item # (39773B x 6)
- Stainless steel light bracket item # (20870)

**20881** 1 Pc. / Bulk

---



#### 94" Stainless Steel Light Bracket with Seven 19 LED 12" Reflector Light Bars - Red LED/Red Lens

- Highly polished stainless steel
- 94" x 1 7/8"
- 19 Red LEDs with red lens item # (39774B x 6)
- Stainless steel light bracket item # (20870)

**20882** 1 Pc. / Bulk

---



#### 94" Stainless Steel Bumper Light Bracket with Seven 19 LED 12" Reflector Light Bars - Amber LED/Clear Lens

- Highly polished stainless steel
- 94" x 1 7/8"
- 19 Amber LEDs with clear lens item # (39775B x 6)
- Stainless steel light bracket item # (20870)

**20883** 1 Pc. / Bulk

---



#### 94" Stainless Steel Light Bracket with Seven 19 LED 12" Reflector Light Bars - Red LED/Clear Lens

- Highly polished stainless steel
- 94" x 1 7/8"
- 19 Red LEDs with clear lens item # (39776B x 6)
- Stainless steel light bracket item # (20870)

**20884** 1 Pc. / Bulk

---

# TERMS & CONDITIONS / ORDERING GUIDELINES / FREIGHT

IMPORTANT: PLEASE REVIEW CAREFULLY

## New Accounts:

Initial minimum buy-in is \$2,000 (or to be determined by United Pacific Industries, UPI hereafter). All initial orders must be prepaid in advance by Cashier's Check or VISA/MC. All new/potential accounts must complete a UPI "New Customer Info/Credit Form" and follow the Dealer Qualification Instructions. Upon completion of the credit application, approved accounts will be assigned payment terms of NET 30 Days (from invoice date). Accounts denied a credit line will be required to prepay in advance by Cashier's Check or VISA/MC.

## PAYMENT TERMS

### Term Accounts:

Accounts with NET 30 Days terms are required to submit payment within the 30 days from the date of invoice. Acceptable forms of payment include checks, ACH (Automated Clearing House), or wire transfer.

A service charge of 1.5% per month will be imposed on invoices not paid within the 30 day term. Delinquent accounts will be required to pay Cash-In- Advance (CIA). Checks will be accepted but orders will not be released until the check is cleared by the bank. Past due invoices will delay current orders. Please check with UPI on your account status when placing an order.

### Credit Cards

Accounts denied credit terms may pay by Visa or MasterCard. Credit card will be charged upon shipment. Credit card payments will not be accepted once an order has been shipped. UPI does not accept American Express or Discover card.

### COD

A \$9.00 fee will be assessed per COD box for all FedEx/UPS COD shipments. Truck COD shipment fees are to be determined later by trucking company.

### Returned Checks:

A \$30 NSF (Non Sufficient Fund) fee will be assessed on each incidence a check is returned to UPI.

## ORDERING GUIDELINES

Placing Orders: New orders may be placed by any of the following methods

1. Fax: **888.986.5988**
2. E-mail: [antique@upauto.com](mailto:antique@upauto.com)
3. Telephone: In order to minimize errors, customers are encouraged to submit their orders by fax or email. Telephone orders should be limited to smaller orders such as add-ons to orders already submitted and/or fill-ins occurring between larger restocking orders.

### Changes to Orders:

Whenever possible, revisions to orders - additions or deletions of items - should also be submitted via fax or email to reduce the possibility of errors.

Additions/Deletion of items will only be accepted within 48 hours after the initial order date and/or before 12:00PM on the date of the shipment. Additions of items placed after the 48 hours time period will be considered a new order and adhere to a new order freight prepaid policy. Deletions of item cannot happen after the 48 hours time period and/or after 12:00PM on the date of the shipment. Please note additions and/or deletions of items will delay the shipment date.

### Canceling Orders:

Cancellation of orders must be submitted via fax or email within 24 hours of the order date. If the order has already shipped it will be the customers responsibility to return the order at the customers own expense. A restocking fee may apply, please see "Return" policy for further detail.

## Backorders:

Customers have the option of having their backorders shipped or canceled. UPI will notify customer as to availability of backorders and will be able to ship any backorder items customer still needs as part of their next stock order. UPI reserves the right to cancel backorders that are 6 months or older from the initial invoice date.

## Minimum Order:

A minimum order of \$50.00 is required. Orders below \$50.00 will be assessed a minimum order fee of \$10.00.

## Packaging:

A 10% service charge will be added to orders with special packaging or UPC barcoding requirements.

## Lead Times:

Standard lead time for all United Pacific orders is 1-3 business days from the receipt of the purchase order. Larger orders may require a lead time of up to 5 business days. Transit time of 3-5 business days must be considered when placing orders. UPI cannot be responsible for delays in shipment after an order leaves our warehouse. UPI will work to resolve delays with freight forwarding firms, however, delays do arise from time to time due to weather and unforeseen circumstances beyond UPI's control. Express order are exempted; please view Freight/Shipping Policy for further detail.

## Order Confirmation:

United Pacific will acknowledge receipt of orders by email/fax/ telephone within 1 business day of receipt. If confirmation is not received, please contact UPI to ensure your order was received.

## FREIGHT

### Prepaid Freight:

Stock orders between \$50 and \$999.99 (US Lower 48 States), **\$50 and \$2499.99 (Alaska and Hawaii)**, **\$50 and \$1499.99 (Canada)**, [all price net US\$], will be shipped FOB Long Beach, California. Stock orders of \$1,000 (US Lower 48 States), **\$2500 (Alaska and Hawaii)**, **\$1500 (Canada)**, [based on UPI current pricing], or more will be shipped Freight Prepaid Ground to a single location only. (See exception for Oversize Items\*). Express Air orders, Special Net Pricing orders, and Special Quote Pricing orders are excluded. United Pacific reserves the right to select the carrier of our choice. Customers may select the carrier of their choice at their own expense, negotiated rates and insurance. If customers elect to choose their own freight carrier, orders will be shipped via FREIGHT COLLECT. **Oversize Item Freight Policy** – Applies to 1932 Ford car & truck body shell assemblies, 1932 Ford car & truck body parts such as floor assembly, roof, door, fender, quarter panel, grille, bulk rail gutter, bulk roof tack strip, chassis & frame, wheels & tire, and any exceptionally large or heavy item.

1. Freight will be prepaid by United Pacific if the total order of all items exceeds \$4,000 (US Lower 48 States) or **\$5000 (Hawaii, Alaska and Canada)**, [all price net US\$]. There will not be additional charges for these items included on the order.
2. Freight will be prepaid by United Pacific if a customer orders a total of \$2,500 (US Lower 48 States) or **\$3500 (Hawaii, Alaska and Canada)**, [all price net US\$], of PB 379 fenders, 60" or longer exhaust, and/or 18"+ Longer Saddle Boxes only. If the order is below \$2,500 (US Lower 48 States) or **\$3500 (Hawaii, Alaska and Canada)**, United Pacific will add freight charges to the order for the oversize items.

## Will Call Orders:

Will Call orders can be picked up 2 - 4 hours after placing the order. Customers should always call ahead to confirm when order will be ready to pick up.

# SHIPPING POLICY / CLAIMS

IMPORTANT: PLEASE REVIEW CAREFULLY

## SHIPPING POLICY

### International Shipments:

Shipments to locations outside the continental United States will be shipped to the customer's shipping agent or broker within the continental United States in accordance with the US freight policy. International customers will be responsible for the duties and taxes of their respective country.

### Express Orders:

All express orders, such as Next Day, Second Day, 3 Day Service & Will Call, must be faxed/emailed. Order confirmation will be faxed to the customer for final approval. If confirmation is not received, please contact UPI to ensure your order was received. Customers are required to sign off on express orders and fax confirmation back to UPI. Cut off for express order is 12:00PM. Express orders received after 12:00PM may or may not ship the same day. Please call UPI to confirm projected shipping date or will call time.

Due to the high cost of express shipments, customer may request UPI to call to confirm freight charges. If customer does not request confirmation, UPI will ship the express order.

### Drop Shipments:

All drop shipment orders will be assessed a 5% processing fee. Drop shipment processing fee will be automatically added to the invoice without notice. All drop shipment orders must be faxed in. No freight allowance or prepaid freight will be permitted for any drop shipments, thus, all drop ship orders, regardless of order size, are FOB Long Beach, CA.

## CLAIMS

### General Policy:

All claims (Shortage, Mis-Shipped, Damage, Overage, Customer Error & Billing Error) must be submitted to UPI within 3 business days of the receipt of shipment. Claims submitted beyond 3 business days of the receipt of shipment will be voided by UPI.

On all shipments, the person who signs and receives the shipment is responsible for noting on the Bill of Lading, in writing, whether any boxes arrived damaged or shorted. Failure to do so will void all claim rights between all parties. UPI will have no recourse against the trucking company if customer does not note any damages or shortages on the Bill of Lading.

The customers receiving department must count and sign for the exact number of boxes received. Failure to follow the above instructions will void all claim rights between all parties.

### Shortages / Mis-Ships / Damages:

While UPI strives to fill every order with 100% accuracy, on occasion an item may get shipped in error or get damaged during shipping. In the event this occurs, please follow the process below. Note: This type of claim must be reported to UPI within three (3) business days of receiving the order.

1. Contact the United Pacific office to initiate the claim. To make it easy for you we have two acceptable methods for requesting the claim:
  - By e-mail : [returns@upauto.com](mailto:returns@upauto.com)
  - By fax : **888.986.5988**
  - \* **Note: To ensure you receive a timely credit, we cannot accept claim requests by phone.**
2. You will be required to provide the following information:
  - Your business name
  - Contact name and telephone number (in case we have questions)
  - Date the order was received

- A copy of the Packing List / Invoice noting the item number and quantity that was shipped in error or damaged during shipping.
  - Special instructions you have for us.
3. UPI will send a return label so you can ship the items back.
  4. Once we receive the miss-shipped/damaged item(s) a credit will be issued to your account on the next billing cycle.
  5. Shortages will be credit to the Customers' account, unless customer would like the shortages replaced.

### Overages:

UPI strives to provide our customers with the best customer service and products, in turn we would greatly appreciate any help from customer in notifying UPI of any shipping overages. Customers will be offered the option of retaining the merchandise or returning the merchandise to UPI at UPI's expense. If the items are to be returned, an RMA number and return shipping label will be provided.

### Customer Errors:

Any item or quantity ordered in error by the customer may be returned by contacting UPI for a RMA No.

1. To make it easy for you we have two acceptable methods for requesting the RMA:
  - By e-mail: [returns@upauto.com](mailto:returns@upauto.com)
  - By fax: **888.986.5988**
  - \* **Note: To ensure you receive a timely RMA credit, we cannot accept RMA requests by phone.**
2. You will be required to provide the following information.
  - \* Your business name
  - \* Contact name and telephone number (in case we have questions)
  - \* A list of the items number and quantity ordered in error
  - \* Special instructions you have for us
3. UPI will review the request to ensure the products are within the return period.
4. Once we have validated the request, United Pacific will issue an RMA number to the customer. In issuing the RMA approval, the following conditions will apply :
  - Returned items are subject to a 20% re-stocking fee.
  - Return shipping costs are the responsibility of the customer.
  - Items must not have any retail/price sticker on exterior packaging or they will be returned to the customer at customer's expense and no credit given.
  - Items must be in good condition with original packaging intact or they will be returned to the customer at customer's expense and no credit given.
  - Allow up to 30 days for the credit to be issued from the time the returned items are received.

### Billing Errors:

Billing errors should be reported to UPI within 3 business days of invoice receipt. Customers are asked to provide the invoice number, part number, and quantities in question. Once verified, UPI will issue a credit or an invoice for the difference in billing error.

# WARRANTY POLICY / RETURNS

IMPORTANT: PLEASE REVIEW CAREFULLY

## WARRANTY POLICY

### General Policy:

UPI offers a NO HASSLE WARRANTY RETURN policy to all our customers. Warranty claims can only be submitted through an authorized UPI Distributor. UPI warranty is not transferable and applies to the original installation and purchase only. In no event shall UPI be liable for incidental or consequential damages, nor shall UPI be liable for any claims or damages arising out of or connected with the UPI warranty exceed the purchase price of the products. There are no warranties, expressed or implied (including any warranty of merchantability or fitness) that extend beyond this warranty. The warranty does not apply to costs associated with the loss of use of the product, loss of time, inconvenience, commercial loss, incidental or consequential damages. UPI reserves the right to alter the designs of products without assuming any obligation to modify previously manufactured products and will only replace warranted products with redesigned products.

Warranty does not apply to merchandise that has been drilled, cut, welded, modified in any way or installed contrary to normal installation and usage. In addition, UPI cannot be held liable for damages caused by road hazards, accidents, misuse, neglect, abuse or corrosive environments including acid washes and highway snow/ice chemicals which can cause discoloration and corrosion in aluminum, chrome, stainless steel and light products. UPI reserves the right to credit returned merchandise at the initial purchase price or at the current selling price, which price ever is lower.

### Aluminum / Chrome / Stainless Steel Products:

All aluminum, chrome, and stainless steel products carry a limited 6 month warranty (from invoice date) against defects in material or workmanship.

### Lighting Products:

#### Incandescent

All incandescent lighting products carry a limited 12 month warranty (from invoice date) against defects in material or workmanship. The limited 12 month warranty does not apply to several applications, such as, buses, construction equipment, and off road vehicles.

#### LED

All LED lighting products carry a specific Limited Warranty (from invoice date) against defects in material or workmanship.

- LED with vehicle specific application is limited lifetime warranty to an original purchaser with receipt. Examples of lifetime warranty product: CTL5720LED CTL5720LED for 1957 Chevy, FTL3201LED-L for 1932 Ford.
- LED Marker, 2", 2-1/2", 4", 7", Oval & Square Lights - Varies from 2 years to 10 years to Limited Lifetime, depending on specific item. The housing, bezel or mounting base on any light made from Chrome/Stainless carries a 6 month limited warranty.
- LED Cab Lights and Kits, Double/Single Stud Turn Signal and PB/KW/FL/VL or non-make Turn Signals and any/all Strip Lights - Varies from 2 years to 10 years to Limited Lifetime, depending on specific item. The housing, bezel or mounting base on any light made from Chrome/Stainless carries a 6 month limited warranty.
- LED Beacon, Driving, Headlights, Work & Warning Lights - Varies from 6 months to 3 years. The housing, bezel or mounting base on any light made from Chrome/Stainless carries a 6 month limited warranty.
- All LED Accessory Lights (Honda, Stainless Steel Double/Single face Lights, Interior Lights, License Plate Lights, and any Accent Lights. The housing, bezel or mounting base on any light made from Chrome/Stainless carries a 6 month limited warranty.

## RETURNS

### General Policy:

All returns must be authorized by UPI. All return requests must be faxed or e-mailed ([returns@upauto.com](mailto:returns@upauto.com)) A RMA number (Return Merchandise Authorization Number) will be provided. Returns not possessing a valid RMA number are subject to rejection and will be returned to sender at the customer's expense. All customers are encouraged to use the Warranty RMA Claim Form.

### Defective Goods / Warranty Return:

UPI offers our customers a No Hassle Warranty Return. Please follow the instructions below for requesting a RMA for defective goods:

1. If any warranty issues occur, simply contact the UPI for RMA number  
To make it easy for you we have two acceptable methods for requesting the RMA:
  - By e-mail: [returns@upauto.com](mailto:returns@upauto.com)
  - By fax: **888.986.5988**
  - **Note: To ensure you receive a timely RMA credit, we cannot accept RMA requests by phone.**
2. You will be required to provide the following information:
  - Your business name
  - Contact name and telephone number (in case we have questions)
  - A list of the defective item number and quantity with the nature/reason of the defect
  - Special instructions you have for us
  - The enclosed fax form may be used for your convenience to request an RMA
3. UPI will review the request to ensure the products are within the stated warranty period.
4. Once we have validated the warranty items, a RMA confirmation, listing the items and cost will be faxed to the customer within 3 business days. UPI will process the credit to your account within 30 days.

**Note: There will be no need to return the warranty product to us. However, from time to time, UPI may require some warranty products to be shipped back so we may analyze the cause of the failure. All warranty products that are required to be shipped back will be freight prepaid by UPI.**

### Stock Return:

United Pacific Industries encourages all customers to regularly monitor the sales volume and stock level of their inventory items. As sales trends may slow the movement of specific items, our hope is that those items are featured as "close-out specials" as to minimize stock returns. We also understand that the customer, from time to time, may accumulate over-stock items and desire to return those. Therefore, we have adopted the following policy below.

#### NOTE:

- Items must have been purchased by the dealer requesting the stock return.
  - Items must have been purchased within the preceding 12 months.
  - Items that have been discontinued will not be considered for return.
1. Contact the United Pacific office for RMA number We have 2 acceptable methods for requesting the RMA:  
By e-mail : [returns@upauto.com](mailto:returns@upauto.com)  
By fax : **888.986.5988**  
**\*Note: To ensure you receive a timely RMA credit, we cannot accept RMA requests by phone.**

# RETURNS / CATALOGS / DISCLAIMER

IMPORTANT: PLEASE REVIEW CAREFULLY

2. You will be required to provide the following information:

- Your business name
- Contact name and telephone number (in case we have questions)
- A list of defective items: Item numbers and quantity of each
- Special instructions you have for us

3. Your claim will be reviewed within 5 business days and you will be contacted by your sales representative who will discuss solutions to liquidate these slow moving items.

4. In the event United Pacific and the customer agree to a credit in lieu of returning the items, this credit will be issued within 10 business days.

5. In the event items are returned by the customer, United Pacific will issue an RMA number to the customer. In issuing the RMA approval, the following conditions will apply:

- Returned items are subject to a 20% re-stocking fee.
- Return shipping costs are the responsibility of the customer.
- Items must not have any retail/price sticker on exterior packaging or they will be returned to the customer at customer's expense and no credit given.
- Items must be in good condition with original packaging intact or they will be returned to the customer at customer's expense and no credit given.
- Allow up to 30 days for the credit to be issued from the time the returned items are received.

6. Stock returns may be requested throughout the year and are subject to a maximum of 5% of prior year annual purchases.

## Closeout/Discontinue Items:

UPI will not warranty or accept returns on Closeout/Discontinue items.

## Procedure:

An inventory of the merchandise being returned must accompany each return. The RMA number should be prominently displayed on each carton/box.

All Returns must be returned freight prepaid.

## Ship Returns to:

United Pacific Industries  
Attn: Returns Department  
3788 E. Conant St.  
Long Beach, CA 90808

## RMA's:

Outstanding RMA's will be automatically canceled if not used within 30 days of issuance.

## CATALOGS

### General Policy:

UPI will send a set of catalogs and price lists upon the arrival any new catalogs and price list. Included in the mailing will be a Catalog Order Form in which customers can request additional copies.

### Catalog/CD Request:

UPI provides additional catalogs/CD's to our customers free of charge. Customer must submit their request on a UPI Catalog Order Form or add the request to their regular restocking order. Requests for additional catalogs/CD's should be submitted along with the regular restocking orders to avoid additional freight charges. Due to the availability of catalogs/CD's, customer's request may be limited to certain quantity. Catalogs/CD's will be shipped along with the customers' order. Customer may request the catalogs be shipped separately, but customer will be responsible for the freight charge.

## Picture Request:

All UPI item pictures are taken professionally by our marketing department. Item pictures can be downloaded online at [www.upauto.com](http://www.upauto.com). Item pictures not posted online can be requested by sending an email to e-mail [graphic@upauto.com](mailto:graphic@upauto.com). All picture requests must state the item no and the format of the picture file, i.e jpeg or high resolution. UPI has over 20,000 SKU's and therefore does not have a CD with all the items.

## DISCLAIMER

United Pacific Industries reserves the right to amend or update our Policies & Procedures without notice.

United Pacific Industries is not responsible for typographical, product information or print errors. Specifications on this catalog may be changed without advance notice. Products may look different from those in the photos on this catalog due to printing quality.

## RMA FORM SAMPLE

|  |  |                        |
|--|--|------------------------|
| <br><b>United Pacific</b><br>3788 CONANT STREET<br>LONG BEACH, CA 90808<br>DIRECT (842) 425-1588<br>TOLL FREE (800) 327-9288<br>FAX (562) 594-8988<br>UPIW01-008 | <b>DEFECTIVE GOODS / WARRANTY CLAIM FORM</b> |                        |
|  | Date: _____                                  | _____                  |
| Company Name _____   | Address _____                                | City, State, Zip _____ |
| Contact Name _____   | Phone Number _____                           | Fax Number _____       |
| Email: _____   | _____  | _____                  |

List defective items below:

| Item# | Qty | Description | Reason for Defect | Date Sold to Customer |
|-------|-----|-------------|-------------------|-----------------------|
|       |     |             |                   |                       |
|       |     |             |                   |                       |
|       |     |             |                   |                       |
|       |     |             |                   |                       |
|       |     |             |                   |                       |
|       |     |             |                   |                       |
|       |     |             |                   |                       |
|       |     |             |                   |                       |
|       |     |             |                   |                       |

Any special notes / instructions for United Pacific (list here):

File your claim at:  
by email - [artr@upac.com](mailto:artr@upac.com)  
by fax - (562) 594-8008

| Internal Use Only        |                      |
|--------------------------|----------------------|
| Date Received: _____     | Final RMA: _____     |
| RMA Approval Date: _____ | Credit Amount: _____ |
| RMA Number: _____        | Approved by: _____   |

## CALIFORNIA PROPOSITION 65 WARNING



WARNING: Cancer & Reproductive Harm-  
[www.P65Warnings.ca.gov](http://www.P65Warnings.ca.gov)

| <b>ITEM #</b> | <b>PAGE #</b> | <b>ITEM #</b> | <b>PAGE #</b> | <b>ITEM #</b> | <b>PAGE #</b> |
|---------------|---------------|---------------|---------------|---------------|---------------|
| 10927         | 29            | 20877         | 46            | 21721B        | 28            |
| 10940         | 20            | 20878         | 47            | 21722B        | 28            |
| 10951         | 43            | 20879         | 46            | 21723B        | 17            |
| 10952         | 43            | 20880         | 47            | 21724         | 7             |
| 10953         | 43            | 20881         | 48            | 21741         | 16            |
| 10954         | 43            | 20882         | 48            | 28000         | 6             |
| 10955         | 43            | 20883         | 48            | 28002         | 24            |
| 20518         | 17            | 20884         | 48            | 28003         | 7             |
| 20562         | 16            | 21061         | 9             | 28006         | 13            |
| 20563         | 28            | 21062         | 9             | 28008         | 14            |
| 20564         | 7             | 21063         | 9             | 28009         | 14            |
| 20565         | 16            | 21064         | 9             | 28011         | 14            |
| 20566         | 7             | 21151         | 10            | 28012         | 14            |
| 20567         | 28            | 21152         | 10            | 28013         | 24            |
| 20568         | 28            | 21153         | 10            | 28013         | 24            |
| 20570         | 28            | 21154         | 10            | 28015         | 15            |
| 20571         | 8             | 21157         | 40            | 29000         | 13            |
| 20572         | 15            | 21160         | 11            | 29001         | 12            |
| 20583         | 26            | 21160         | 29            | 29002         | 12            |
| 20584         | 16            | 21161         | 29            | 29003         | 12            |
| 20585         | 15            | 21162         | 29            | 29004         | 23            |
| 20610         | 17            | 21165         | 11            | 29005         | 22            |
| 20671         | 44            | 21166         | 11            | 29006         | 22            |
| 20672         | 45            | 21409         | 43            | 29009         | 23            |
| 20673         | 44            | 21411         | 43            | 29010         | 23            |
| 20674         | 45            | 21533         | 42            | 29011         | 23            |
| 20675         | 44            | 21534         | 42            | 29012         | 34            |
| 20676         | 45            | 21538         | 43            | 29013         | 34            |
| 20677         | 44            | 21539         | 42            | 29014         | 34            |
| 20695         | 11            | 21540         | 42            | 29015         | 39            |
| 20816         | 43            | 21551         | 42            | 29016         | 39            |
| 20873         | 45            | 21552         | 42            | 29017         | 39            |
| 20874         | 46            | 21718         | 17            | 29020         | 19            |
| 20875         | 46            | 21719         | 8             | 29021         | 20            |
| 20876         | 47            | 21720         | 29            | 29022         | 19            |

| ITEM # | PAGE # |
|--------|--------|
| 29023  | 19     |
| 29024  | 19     |
| 29025  | 21     |
| 29026  | 18     |
| 29027  | 20     |
| 29028  | 20     |
| 29040  | 30     |
| 29041  | 25     |
| 29042  | 26     |
| 29043  | 24     |
| 29044  | 25     |
| 29045  | 27     |
| 29046  | 26     |
| 29046  | 26     |
| 29047  | 32     |
| 29048  | 31     |
| 29049  | 33     |
| 29050  | 32     |
| 29051  | 31     |
| 29052  | 31     |
| 29053  | 32     |
| 29054  | 32     |
| 29055  | 33     |
| 29056  | 30     |
| 29060  | 36     |
| 29061  | 35     |
| 29062  | 35     |
| 29063  | 35     |
| 29064  | 35     |
| 29065  | 36     |
| 29066  | 36     |
| 29067  | 36     |
| 29068  | 37     |
| 29070  | 39     |
| 29071  | 40     |

| ITEM # | PAGE # |
|--------|--------|
| 29072  | 40     |
| 29073  | 40     |
| 29090  | 6      |
| 29091  | 6      |
| 29092  | 5      |
| 29093  | 6      |
| 29094  | 5      |
| 29095  | 18     |
| 29096  | 18     |
| 29097  | 5      |
| 29098  | 8      |
| 29100  | 5      |
| 29102  | 24     |
| 29102  | 24     |
| 29103  | 27     |
| 29105  | 25     |
| 29106  | 30     |
| 29108  | 27     |
| 29109  | 22     |
| 29109  | 22     |
| 29110  | 30     |
| 29112  | 26     |
| 29113  | 33     |
| 29115  | 25     |
| 29116  | 31     |
| 29118  | 29     |
| 29119  | 27     |
| 29120  | 33     |
| 29121  | 33     |
| 29122  | 22     |
| 29123  | 38     |
| 29124  | 38     |
| 29125  | 38     |
| 29126  | 38     |
| 29128  | 13     |

| ITEM # | PAGE # |
|--------|--------|
| 29129  | 15     |
| 29130  | 13     |
| 29131  | 21     |
| 29132  | 21     |
| 29133  | 17     |
| 29134  | 12     |
| 29135  | 18     |
| 29136  | 21     |
| 29139  | 37     |
| 29141  | 34     |
| 29142  | 41     |
| 29143  | 41     |
| 29144  | 41     |
| 29145  | 41     |
| 29146  | 41     |
| 42374  | 7      |
| 42375  | 7      |
| 41667B | 37     |
| 41668B | 37     |



**UCSS1**  
TRUCK STAINLESS STEEL CATALOG



710270058631

**UPauto.com | T 800.790.6988 | F 888.986.5988**

© 2019 United Pacific Industries. All Rights Reserved. Products not shown to scale. Specifications subject to change without notice.